

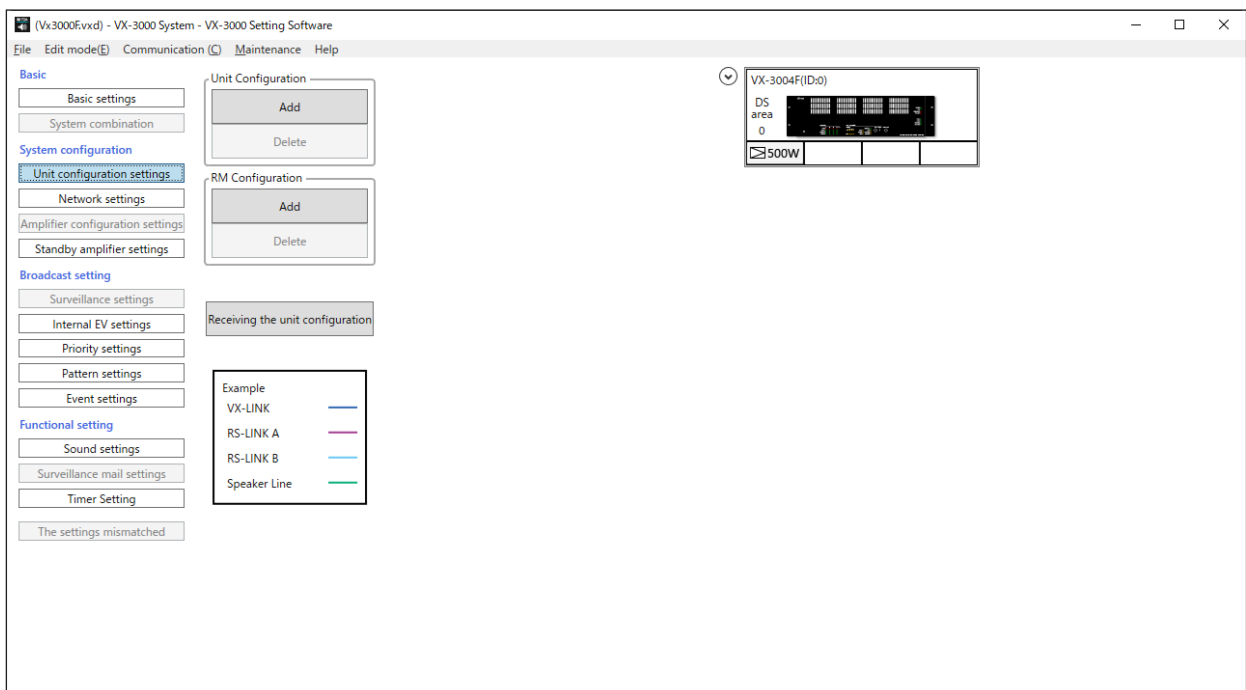

## SETTING SOFTWARE INSTRUCTIONS

For Authorized Administrator and Installer

# INTEGRATED VOICE EVACUATION SYSTEM VX-3000 SERIES



### Tips

- In this manual, the VX-3004F/3008F/3016F Voice Evacuation Frames are collectively referred to as "VX-3000F."
- Set the VX-3308WM as the VX-3008F.

Thank you for purchasing TOA's Integrated Voice Evacuation System.  
Please carefully follow the instructions in this manual to ensure long, trouble-free use of your equipment.

# TABLE OF CONTENTS

## *Chapter 1 : SETTING SOFTWARE OUTLINE*

<b>1. SOFTWARE OUTLINE</b> .....	1-2
<b>2. NOTES ON PERFORMING SETTINGS</b> .....	1-2
2.1. System Requirements .....	1-2
2.2. Notes .....	1-2
<b>3. SOFTWARE SETUP</b> .....	1-3
3.1. Setting Software Installation .....	1-3
3.2. Uninstallation .....	1-5
<b>4. STARTING THE VX-3000 SETTING SOFTWARE</b> .....	1-6
<b>5. SELECTING A USER</b> .....	1-7
<b>6. SIMPLE MODE AND NORMAL MODE</b> .....	1-7

## *Chapter 2 : USING IN THE SIMPLE MODE*

<b>1. SETTING TO THE SIMPLE MODE</b> .....	2-2
<b>2. FUNCTIONS ENABLED WITH THE SIMPLE MODE</b> .....	2-3
<b>3. SETTING PROCEDURE</b> .....	2-4
3.1. When Creating a Setting Project File in Advance .....	2-4
3.2. When Creating the Setting Project File at the Installation Site .....	2-5
<b>4. SETTING ITEM</b> .....	2-6
4.1. Setting Item Button Configuration .....	2-6
4.2. Menu Bar .....	2-6
<b>5. CREATE A NEW SETTING PROJECT FILE</b> .....	2-8
<b>6. BASIC SETTINGS</b> .....	2-18
<b>7. UNIT CONFIGURATION SETTINGS</b> .....	2-19
7.1. Adding the VX-3000F to the Unit Configuration .....	2-20
7.2. Deleting the VX-3000F from the Unit Configuration .....	2-22
7.3. Adding the Remote Microphone to the RM Configuration .....	2-22
7.4. Deleting the Remote Microphone from the RM Configuration .....	2-23
7.5. Setting the VX-3000F's Unit Configuration .....	2-23
7.6. Setting the Remote Microphone Configuration .....	2-26
<b>8. PRIORITY SETTINGS</b> .....	2-28
<b>9. BROADCAST SETTING</b> .....	2-31
9.1. General Broadcast Setting .....	2-31
9.2. Control Output Setting .....	2-34

<b>10. EVENT SETTINGS</b> .....	2-36
10.1. Control Input Setting .....	2-36
10.2. Remote Microphone Setting .....	2-38
<b>11. CONFIRMING DISCREPANCIES IN SET DATA</b> .....	2-40
<b>12. APPENDIX: ITEMS TO BE AUTOMATICALLY REGISTERED</b> .....	2-41

## ***Chapter 3 : USING IN THE NORMAL MODE***

<b>1. SETTING TO THE NORMAL MODE</b> .....	3-2
<b>2. SETTING PROCEDURE</b> .....	3-3
2.1. When Creating a Setting Project File in Advance .....	3-3
2.2. When Creating the Setting Project File at the Installation Site .....	3-5
2.3. When Changing the Setting by After Acquiring It from the Unit .....	3-6
<b>3. EXPLANATIONS OF TERMS AND FUNCTIONS</b> .....	3-7
3.1. Pattern .....	3-7
3.2. Event .....	3-7
3.3. Internal EV .....	3-7
3.4. General-Purpose Broadcasts .....	3-7
3.5. Base Pattern Broadcast .....	3-11
3.6. Emergency Warning Broadcast .....	3-12
3.7. Emergency Broadcast .....	3-15
3.8. Surveillance Function .....	3-20
3.9. ANC Function .....	3-24
3.10. VOX Function .....	3-30
3.11. Network Area Division Function .....	3-32
<b>4. SETTING ITEMS</b> .....	3-34
4.1. Setting Item Button Configuration .....	3-34
4.2. Menu Bar .....	3-35
<b>5. CREATE A NEW SETTING PROJECT FILE</b> .....	3-37
<b>6. BASIC SETTINGS</b> .....	3-38
<b>7. SYSTEM SETTINGS</b> .....	3-41
7.1. Unit Configuration Settings .....	3-41
7.2. Adding the VX-3000F to the Unit Configuration .....	3-43
7.3. Deleting the VX-3000F from the Unit Configuration .....	3-47
7.4. Adding the Remote Microphone to the RM Configuration .....	3-48
7.5. Deleting the Remote Microphone from the RM Configuration .....	3-48
7.6. Adding the VX-3000PM to the Unit Configuration .....	3-49
7.7. Deleting the VX-3000PM from the Unit Configuration .....	3-49
7.8. Adding the VX-3000CT to the Unit Configuration .....	3-49
7.9. Deleting the VX-3000CT from the Unit Configuration .....	3-50
7.10. Receiving the Unit Configuration .....	3-51
7.11. Setting the VX-3000F's Unit Configuration .....	3-54
7.12. Setting the Remote Microphone Configuration .....	3-61
7.13. Setting the VX-3000PM's Configuration .....	3-67

<b>8. NETWORK SETTINGS</b> .....	3-70
<b>9. AMPLIFIER CONFIGURATION SETTING</b> .....	3-73
<b>10. STANDBY AMPLIFIER SETTINGS</b> .....	3-74
10.1. Adding a Standby Amplifier .....	3-75
10.2. When Not Sharing the Standby Amplifier .....	3-76
<b>11. SURVEILLANCE SETTINGS</b> .....	3-77
<b>12. INTERNAL EV SETTING</b> .....	3-81
12.1. Registration Tab .....	3-81
12.2. EV Message Setting Tab .....	3-84
12.3. Chime Sound Source Tab .....	3-87
<b>13. PRIORITY SETTINGS</b> .....	3-88
<b>14. PATTERN SETTINGS</b> .....	3-91
14.1. Output Zone Pattern Setting .....	3-93
14.2. Broadcast Setting Between Networks .....	3-95
14.3. Base Pattern Setting .....	3-96
14.4. General Broadcast Pattern Setting .....	3-98
14.5. Control Output Pattern Setting .....	3-100
14.6. Emergency Sequence Setting .....	3-101
14.7. Emergency Broadcast Pattern Setting .....	3-102
14.8. Control Output Setting Interlocked with the Emergency Broadcast State .....	3-104
14.9. Failure Pattern Setting .....	3-105
<b>15. EVENT SETTINGS</b> .....	3-108
15.1. Assignable Functions and Explanations .....	3-108
15.2. Function Description .....	3-113
15.3. Control Input Event Setting .....	3-126
15.4. RM Event Setting .....	3-132
15.5. VX-3000CT Setting .....	3-140
15.6. Fault LED Setting .....	3-145
15.7. Audio Network Output Setting .....	3-146
<b>16. SOUND SETTINGS</b> .....	3-147
16.1. Sound Settings (Input) Tab .....	3-148
16.2. Sound Settings (Output) Tab .....	3-152
16.3. Sound Settings (ANC) Tab .....	3-156
<b>17. SURVEILLANCE MAIL SETTINGS</b> .....	3-158
17.1. Basic Settings .....	3-159
17.2. Mailing List Settings .....	3-160
<b>18. TIMER SETTING</b> .....	3-162
18.1. Registering the Daily Program .....	3-162
18.2. Creating a Weekly Program .....	3-167
18.3. Creating a Holiday Program .....	3-168
<b>19. CONFIRMING DISCREPANCIES IN SET DATA</b> .....	3-169

<b>20. MAINTENANCE</b> .....	3-170
20.1. Maintenance Screen .....	3-170
20.2. Basic Settings .....	3-171
20.3. Log File .....	3-177
20.4. Send Mail Log .....	3-181
20.5. Online Log .....	3-182
20.6. Indicate the Unit Status .....	3-185
20.7. Indicate the Broadcasting Status .....	3-188
20.8. Indicate for Terminal Status .....	3-190
20.9. Initializing the Speaker Line Impedance .....	3-192
20.10. Editing the speaker line impedance, etc. ....	3-195
20.11. Measuring the Reference Value of the ANC Sensor Level .....	3-202
<b>21. UNIT DETECTION AND NETWORK SETTINGS</b> .....	3-205
21.1. Activating the TOA Finder .....	3-205
21.2. Detecting Units .....	3-206
21.3. Detect Unit Screen Description .....	3-207
21.4. Finding VX-3000 Unit .....	3-208
21.5. Restarting VX-3000 Unit .....	3-208
21.6. Changing the Unit Setting Values Related to the Network .....	3-209
<b>22. PRINTING LABELS FOR REMOTE MICROPHONES</b> .....	3-211
<b>23. USER AUTHENTICATION SETTING</b>	
<b>(allowed only by Administrator authority)</b> .....	3-214
23.1. Types of Access Level .....	3-214
23.2. Changing the Password for Each Access Level .....	3-214

# ***Chapter 1***

---

## ***SETTING SOFTWARE OUTLINE***

# 1. SOFTWARE OUTLINE

This setting software is designed to be installed in a PC and used exclusively for performing the settings necessary for operating the VX-3000 system.

Settings are roughly divided into system configurations, failure detection points, broadcasting sound source priorities, broadcast zones, and function assignment to the control inputs and remote microphone keys. This software also features a log function that integrates event log data from the VX-3000F into a PC and displays such data, as well as an error list function that shows discrepancies in set data.

Loading the PC-set data into the VX-3000F allows the VX-3000 system to operate according to the configured settings.

## 2. NOTES ON PERFORMING SETTINGS

### 2.1. System Requirements

- OS: Windows 7 (32 bit/64 bit), Windows 8.1 (32 bit/64 bit), Windows 10 (32 bit/64 bit)
- Required Component: Microsoft .NET Framework 4.5.2 (when the OS is Windows 7 or Windows 8.1)
- CPU: 1 GHz or faster
- Memory: Over 1 GB for the 32-bit OS or over 2 GB for the 64-bit OS

#### **Note**

Microsoft and Windows are the registered trademarks of Microsoft Corporation in the United States and other countries.

### 2.2. Notes

#### 2.2.1. Displays

The VX-3000 Setting software creates window displays at a resolution of 1024 x 768 pixels. Setting the screen size to a lower resolution or resizing windows may cause a portion of display to be hidden or cut off.

#### 2.2.2. Window screens

The windows displayed by the VX-3000 Setting software in this manual are examples and may vary somewhat depending on the specific environment of the PC used.

### 3. SOFTWARE SETUP

#### Notes

- Close all open applications before installing.
- To install the software, it is necessary to log in to the PC using an administrator account.

#### 3.1. Setting Software Installation

**Step 1.** Click on "setup.exe" in the setting software folder contained in the CD supplied with the VX-3000F. The installation wizard screen is displayed.

#### Note

The installation wizard screen may not be displayed. In this case, read [the next page](#).

**Step 2.** Click the Next button.

The License Agreement screen is displayed. Check the contents of the License Agreement, then choose the "I Agree" or "I Do Not Agree" radio button. Choosing "I Agree" allows to click the Next button.

**Step 3.** Click the Next button.

The Select Installation Folder screen is displayed.

**Step 4.** Change the folder as needed, then click the Next button.

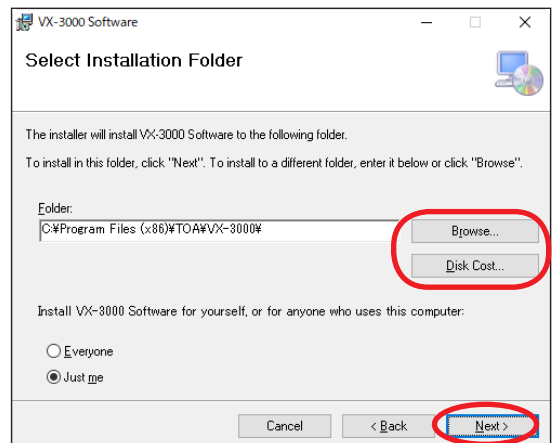
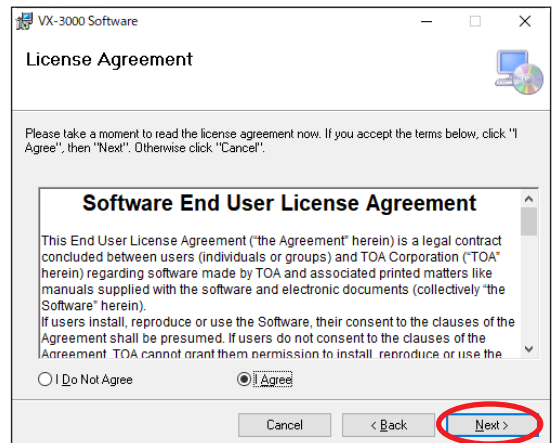
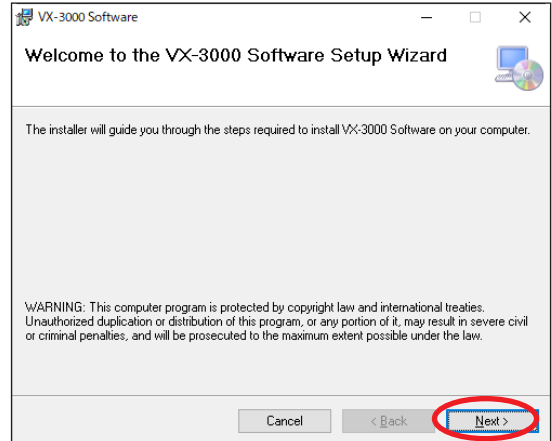

The Confirm Installation dialog is displayed.

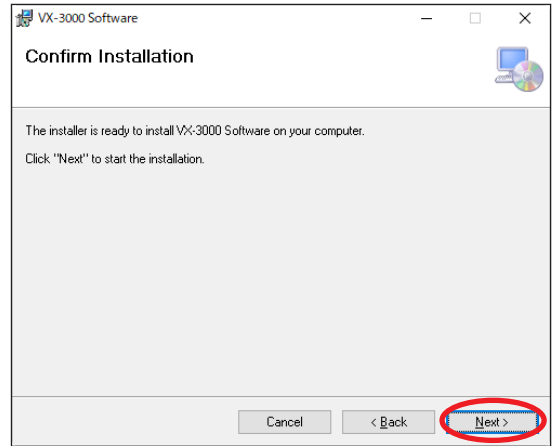

**Step 5.** Click the Next button to start installing the software.

**Step 6.** When the Installation Complete dialog is displayed, click the Close button to complete the installation.

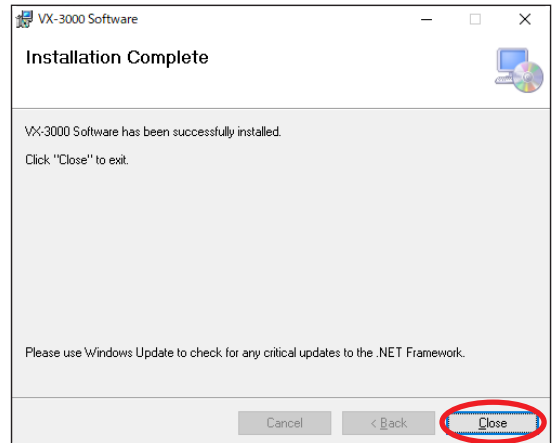

**[If no installation wizard screen is displayed]**

The screen at right may be displayed when the **Step 1** is performed. In this case, install the software needed to run the VX-3000 Setting software with the steps below.

**Step 1.** Click the Yes button.

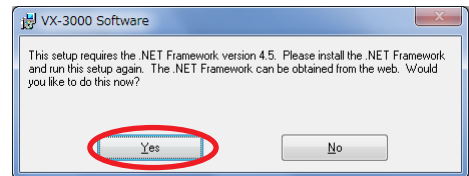

Download site is displayed.

**Step 2.** Download the software according to its instructions.

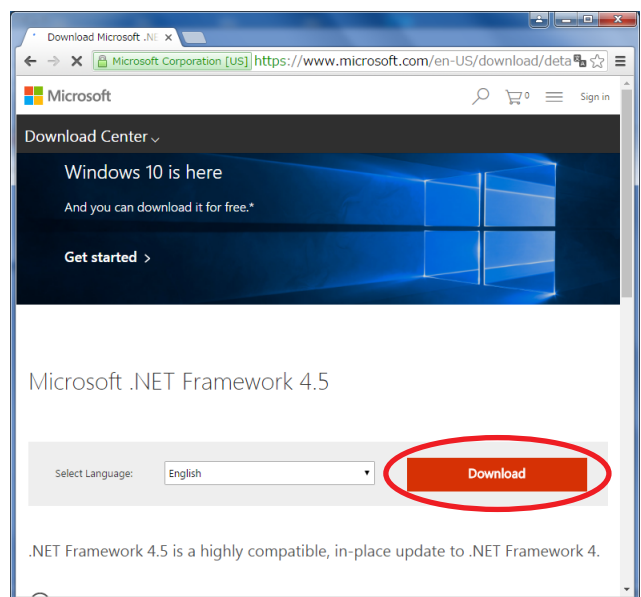

As the installation wizard screen is displayed after completion of installation, follow the steps shown on [the previous page](#).

## 3.2. Uninstallation

**Step 1.** Click on "setup.exe" in the setting software folder contained in the CD supplied with the VX-3000F. The setup wizard screen is displayed.

**Step 2.** Select "Remove VX-3000 Software," and click the Finish button to start uninstalling the software.

**Step 3.** When the Installation Complete dialog is displayed, click the Close button to complete the uninstallation.

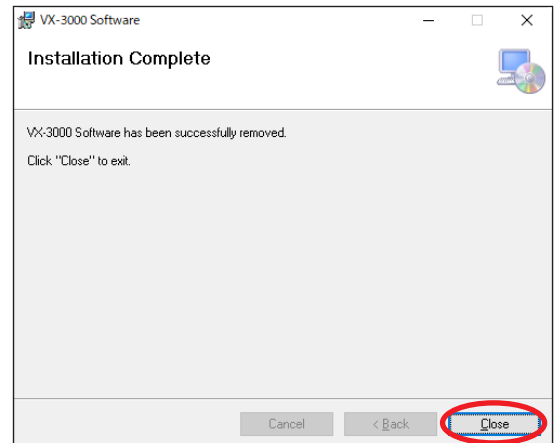
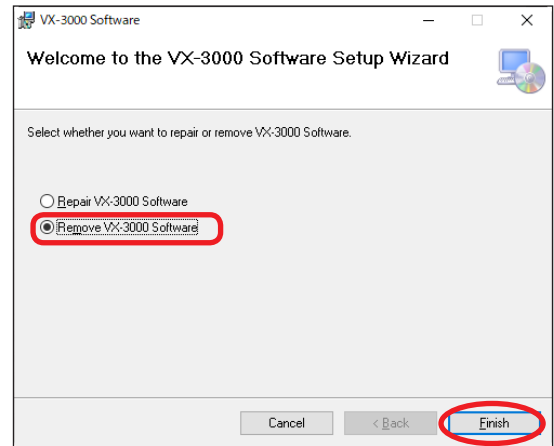

## 4. STARTING THE VX-3000 SETTING SOFTWARE

**Step 1.** Select "VX-3000 Setting Software" from the Start menu, or double-click the VX-3000 Setting Software shortcut icon on the desktop.

Start menu

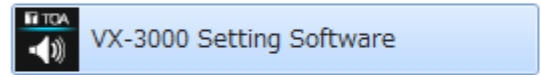

Shortcut icon on the desktop



A user selection dialog appears.

**Step 2.** Select the target user, then click the Start button. (For the user category, read [the next page](#).)

Selecting the "End User" allows the VX-3000 Setting software to start as an End User authority. If the user other than the "End User" is selected, a password entry dialog will appear.

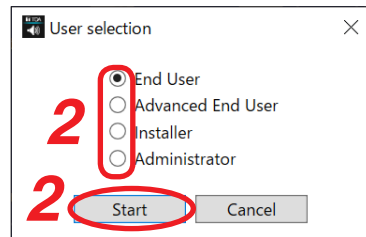

**Step 3.** Enter the password.

If a correct password is entered, the Start button becomes active.

Shown below are the initial passwords.

Advanced End User: advancedenduser  
 Installer: installer  
 Administrator: administrator

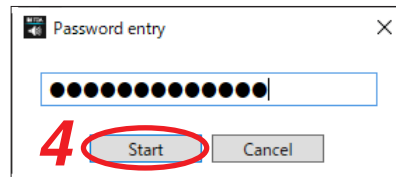
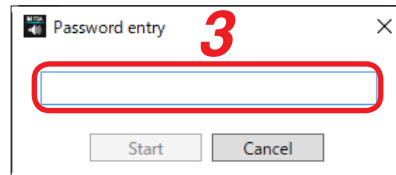

**Step 4.** Click the Start button.

The VX-3000 Setting software is activated. When the VX-3000 Setting software is started for the first time, it will start in the Simple mode. On the next time and thereafter, it will start in the setting mode that was used last time. (For the setting modes, see [the next page](#).)

(Screen example in the Simple mode when started as an Administrator)

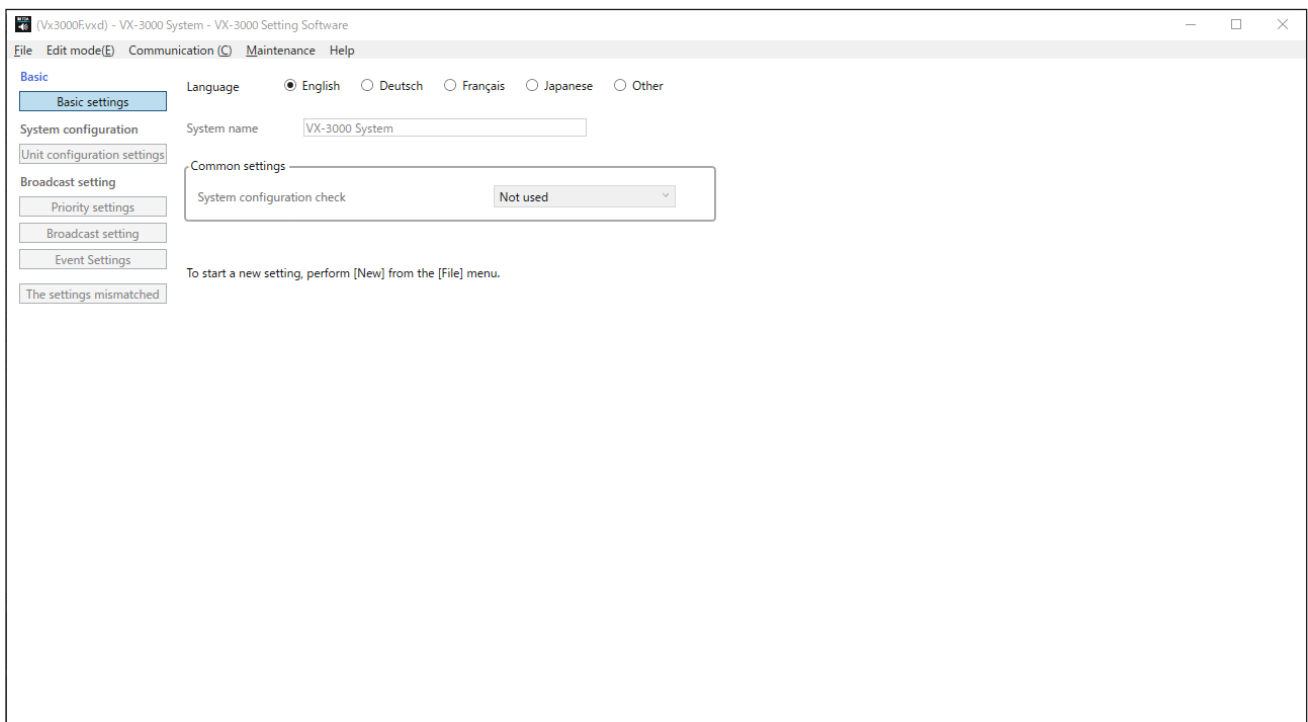

## 5. SELECTING A USER

Four types of access level described below are available for the VX-3000 Setting software to limit the usable range depending on the user level.

- End User:** Only the maintenance function is allowed to use.  
A person who only checks the status of devices is assumed as the user.  
The End User can use the Setting software without entering the password at its start.
- Advanced End User:** Only updating the internal EV data for general broadcast, weekly and holiday programs of the timer setting, and the maintenance function are allowed to perform.  
An equipment manager of the building is assumed as the user.  
At the time of software start, password (default: advancedenduser) entry is required.
- Installer:** All functions except changing the password for user authentication are allowed to use.  
An installer or setting contractor is assumed as the user.  
At the time of software start, password (default: installer) entry is required.
- Administrator:** All functions are allowed to use.  
The VX-3000 system administrator is assumed as the user.  
At the time of software start, password (default: administrator) entry is required.

Only when the software is started as the Administrator, the password can be changed.  
For changing the password, see [p. 3-214](#).

## 6. SIMPLE MODE AND NORMAL MODE

The VX-3000 Setting software features the following 2 setting modes. Setting mode can be switched when the software is started with the Administrator level or Installer level.

- Simple mode:** Allows only the minimum setting items required for the general broadcast to be displayed and changed for users who do not use the complicated settings.  
Unchangeable setting items will be automatically registered depending on the unit configuration.  
Broadcast audio output can be checked by a simple setting.  
Files created in the Normal mode cannot be opened. They can be opened in the Normal mode after a confirmation dialog is displayed.
- Normal mode:** Allows all setting items to be changed.  
Files created in the Simple mode can be opened and settings can be changed. But if you change the setting item that cannot be changed in the Simple mode, such setting can be used only in the Normal mode.

When starting the VX-3000 Setting software for the first time after it has been installed, it will start in the Simple mode.

Next time and later, it will start in the setting mode that was used last time.

# ***Chapter 2***

---

***USING IN THE SIMPLE MODE***

## 1. SETTING TO THE SIMPLE MODE

The VX-3000 Setting software is placed in the Simple mode at the first start-up after it has been installed. It is also placed in the Simple mode at the start-up after it was terminated in the Simple mode. As the VX-3000 Setting software gets into the Normal mode at the start-up after it was terminated in the Normal mode, change the mode to the Simple mode with the procedures below.

**Step 1.** Select [Edit mode] → [Simple mode] from the menu bar.

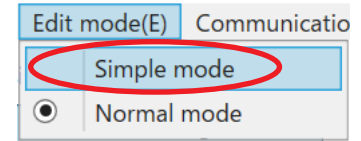

A dialog at right appears.

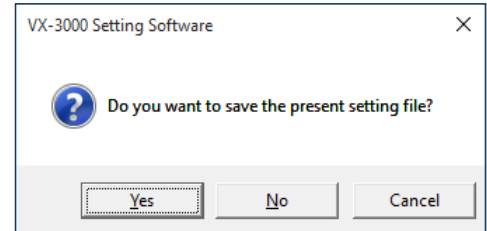

**Step 2.** Click the "Yes" or "No" button as needed.

When the Yes button has been clicked, select the designation folder and save the current setting.

After the setting is saved or cancelled, a new creation wizard screen appears.

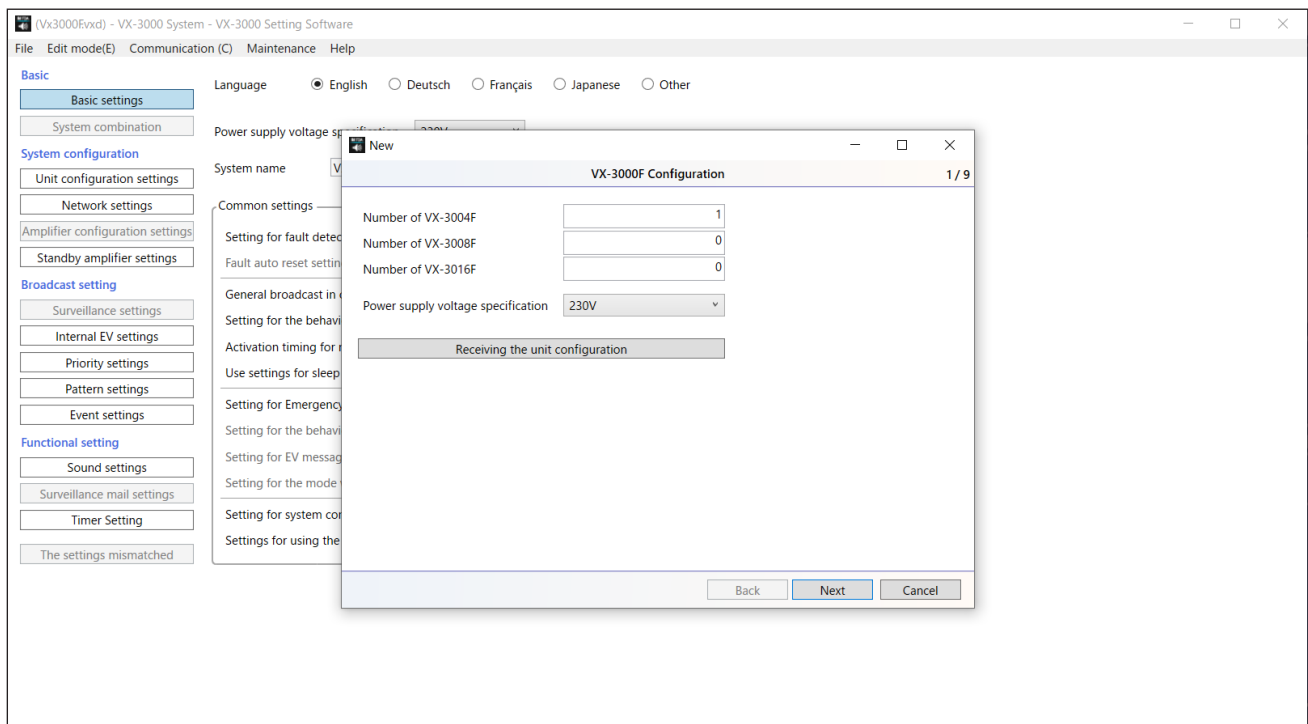

**Step 3.** Continue to set the necessary items according to the new creation wizard, or terminate the new creation wizard by clicking the Cancel button.

The setting method by way of the new creation wizard is the same as that when you select [File] → [New] from the menu bar. See p. 2-8 "CREATE A NEW SETTING PROJECT FILE."

## 2. FUNCTIONS ENABLED WITH THE SIMPLE MODE

In the Simple mode, easy check of the broadcast audio output is enabled as the minimum setting items required for the general broadcast can be automatically registered if the unit configuration is entered according to the new creation wizard.

Only the settings of input sound source output destination, broadcast priority level, and broadcast start method can be changed.

Sound source from the VX-3000F's audio input can be broadcast to all zones as BGM, and announcements can be made to the selected zones from the remote microphone. The control output that is activated in interlock with the broadcast can be set.

Though the failure detection function is not used in the initial setting, you can change the setting so as to enable only the device connection status to be detected.

All settings except those described hereinafter remain as initial ones.

Use the network setting as it is as initial one.

Following items cannot be changed as they are not displayed. They remain in the state of initial setting, and cannot be used.

- Emergency broadcast
- Emergency warning broadcast
- Standby amplifier
- ANC function
- VOX function
- Timer setting

Also, the settings related to the VX-3000PM, VX-3000CT, and VX-300LO cannot be made.

Though the complicated settings cannot be made in this mode, it is possible to simply complete the setting because the settable items are narrowed to a part of the general broadcast items.

## 3. SETTING PROCEDURE

### 3.1. When Creating a Setting Project File in Advance

Shown below is a general procedure for creating a Setting project file in advance and uploading it on completion of the unit detection at the installation site.

#### 1. Create a new setting project file.

- (1) Select [File] → [New] from the menu bar, then start setting according to the new creation wizard.
- (2) Perform settings from "Basic settings" to "Event settings" in order from the top of the menu item to the bottom.
  - Basic settings: Perform settings related to the entire system such as displayed language setting of the Setting software and system name.
  - Unit configuration settings: Change the unit configuration of the VX-3000F units and the remote microphones as needed.
  - Priority settings: Set priority levels for each sound source of the VX-3000F's audio inputs and remote microphones.
  - Broadcast setting: Set the audio inputs and output destinations of the general broadcast, and control input groups.
  - Event settings: Assign a function to each of the control inputs and remote microphone's keys.

#### 2. Save the setting project file.

Select [File] → [Save As] from the menu bar to save the setting project file.

#### 3. Connect to the VX-3000F online, then transmit the settings from the Setting software.

Select [Communication] → [Setting data & Audio source upload (PC->VX)] from the menu bar to transmit the Setting project file to the VX-3000F.

**Tip**

A password input dialog appears when a password has been set to the VX-3000F (No password is set by default.).

If a password is entered, the setting data and the audio data will be written.

Perform the password setting on the maintenance screen.

As the setting procedure is the same as that in the Normal mode, see [p. 3-176 "Password setting."](#)

### 3.2. When Creating the Setting Project File at the Installation Site

Shown below is a general procedure for creating a Setting project file after having acquired the unit configuration by executing the unit detection at the installation site.

#### 1. Connect to the VX-3000F online to acquire the unit configuration data.

- (1) Select [File] → [New] from the menu bar, then click the [Receiving the unit configuration] button on the VX-3000F configuration screen of the new creation wizard.
- (2) Check the target checkbox for the unit to receive the unit configuration data from the displayed unit list, then click the OK button.

#### 2. Create the setting project file.

Perform settings from "Basic settings" to "Event settings" in order from the top of the menu item to the bottom.

- Basic settings: Perform settings related to the entire system such as displayed language setting of the Setting software and system name.
- Unit configuration settings: Change the unit configuration of the VX-3000F units and the remote microphones as needed.
- Priority settings: Set priority levels for each sound source of the VX-3000F's audio inputs and remote microphones.
- Broadcast setting: Set the audio inputs and output destinations of the general broadcast, and control input groups.
- Event settings: Assign a function to each of the control inputs and remote microphone's keys.

#### 3. Save the setting project file.

Select [File] → [Save As] from the menu bar to save the setting project file.

#### 4. Transmit the settings from the Setting software to the VX-3000F.

Select [Communication] → [Setting data & Audio source upload (PC->VX)] from the menu bar to transmit the Setting project file to the VX-3000F.

**Tip**

A password input dialog appears when a password has been set to the VX-3000F (No password is set by default.).

If a password is entered, the setting data and the audio data will be written.

Perform the password setting on the maintenance screen.

As the setting procedure is the same as that in the Normal mode, see [p. 3-176 "Password setting."](#)

## 4. SETTING ITEM

### 4.1. Setting Item Button Configuration

#### Note

At the start-up in the Simple mode, only "Language" in the "Basic settings" of the setting items shown below can be set, but others not.

Executing a new creation, read of the saved setting file, or the setting download from the VX-3000F permits all setting items to be accessed.

#### 4.1.1. Basic

Basic settings:

Language: Select the displayed language.

System name: Set the desired system name.

Common settings: Sets whether or not to detect the device connection confirmation.

#### 4.1.2. System configuration

Unit configuration settings: Set the unit configuration of the VX-3000F and remote microphones.

#### 4.1.3. Broadcast setting

Priority settings: Set the priority levels for General-purpose broadcasts.

Broadcast setting: Perform settings related to General-purpose broadcasts and control outputs.

Event settings: Assign a function to each of the control inputs and remote microphone's keys.

The settings mismatched: Check for errors in the setting.

## 4.2. Menu Bar

### 4.2.1. File

#### Note

At the start-up in the Simple mode, only "New," "Open," and "Exit" of the menu items shown below can be executed, but others not.

Executing a new creation, read of the saved setting file, or the setting download from the VX-3000F permits all setting items to be accessed.

New: Creates a new data file to be used by the VX-3000 Setting software.

Open: Reads an existing data file (Extension: vxd) to be used by the VX-3000 Setting software. The read data file name and system name appear in the title bar on the setting screen.

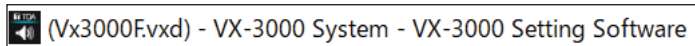

Save: Saves the information currently being edited by the VX-3000 Setting software and overwrites an existing data.

Save as: Saves the information currently being edited by the VX-3000 Setting software under a new file name.

Data output:

Setting data: Saves the setting data in CSV format.

RM label: Creates and prints labels used to identify the keys on remote microphones (RM-200SF, RM-320F, RM-300X, and RM-210F).

Printing method is the same as that when in the Normal mode. (See [p. 3-211 "PRINTING LABELS FOR REMOTE MICROPHONES."](#))

Exit: Quits the VX-3000 Setting software.

#### 4.2.2. Edit mode

Simple mode: Switches to the Simple mode.

Normal mode: Switches to the Normal mode.

#### 4.2.3. Communication

##### Note

At the start-up in the Simple mode, operation of "Setting data & Audio source upload (PC->VX)" cannot be performed.

Executing a new file creation, read of the saved setting file, or the setting download from the VX-3000F permits this setting item to be accessed.

Setting data & Audio source upload (PC->VX): Writes setting data and sound sources to the VX-3000F.

Setting data & Audio source download (VX->PC): Reads setting data and sound sources from the VX-3000F.

#### 4.2.4. Maintenance

Maintenance: Shows the maintenance screen.  
The operation of the maintenance screen is the same as that when in the Normal mode. (See [p. 3-170.](#))

Unit detection & network settings: Detect the devices connected to the local network and perform the network settings for them.  
The methods for both the device detection and the network setting are the same as those when in the Normal mode. (See [p. 3-205.](#))

#### 4.2.5. Help

User authentication setting: (Only when the software is started with the Administrator authority)  
The password that has been set for each access authorization of the VX-3000 Setting software can be changed.

Version: Displays the version number of the VX-3000 Setting software.

## 5. CREATE A NEW SETTING PROJECT FILE

**Step 1.** Select [File] → [New] from the menu bar.

The VX-3000F configuration screen of the new creation wizard appears.

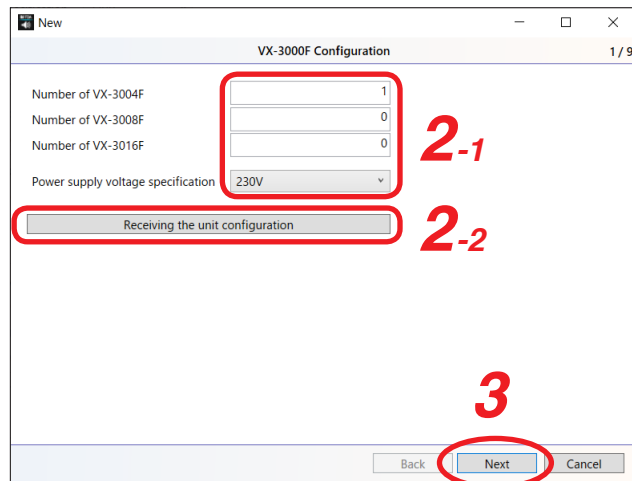

**Step 2.** Set the VX-3000F's equipment configuration.

**2-1.** When manually making the setting

**[1]** For the number of the VX-3000F units, enter the number of the built-in amplifiers ranging from "0" to "40."

Default settings are as follows.

VX-3004F: 1

VX-3008F: 0

VX-3016F: 0

**Notes**

- The total number of the units must be set in the range of 1 to 40.
- Up to 40 VX-3000F units including the extension units can be used in a system.
- In the Simple mode, neither the extension unit nor the standby amplifier can be set.

**[2]** Select the specification of power supply voltage.

Default setting is "230 V."

## 2-2. When receiving the unit configuration

[1] Click the [Receiving the unit configuration] button.

The "Receiving the unit configuration" window appears and the VX-3000F units detected on the local network will be listed.

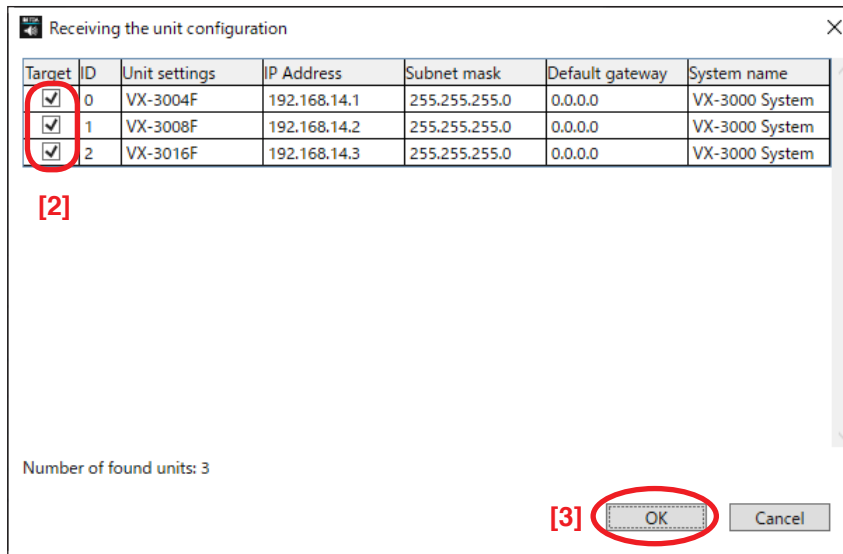
**Note**

When multiple IP addresses are set in a PC, the source IP address selection screen is displayed before the unit detection is executed, then select the desired IP address.

[2] Check the checkboxes for the units of which unit configuration data you want to acquire.

**Note**

When the IDs overlap, you can select only one of them.

[3] Click the OK button.

Reception starts.

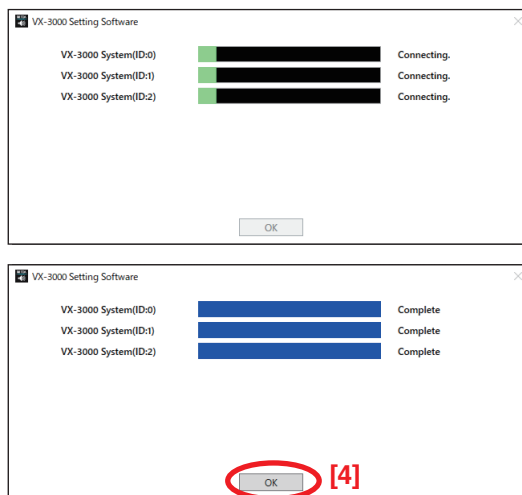
**Notes**

- The dialog at right appears in the following cases.
  - When the VX-3008F or the VX-3016F both having no built-in digital amplifier module is detected
  - When the VX-3000F with the built-in VX-300LO is detected
- In the simple mode, you cannot configure the VX-3000F without a built-in digital amplifier module and the VX-3000F with the built-in VX-300LO.

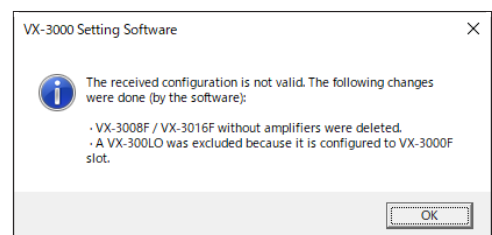

- [4] Click the OK button.  
The amplifier setting window is displayed.  
Proceed to **Step 4**.

- Step 3.** (Only when the unit configuration is manually set) Click the Next button.  
The amplifier setting window is displayed.

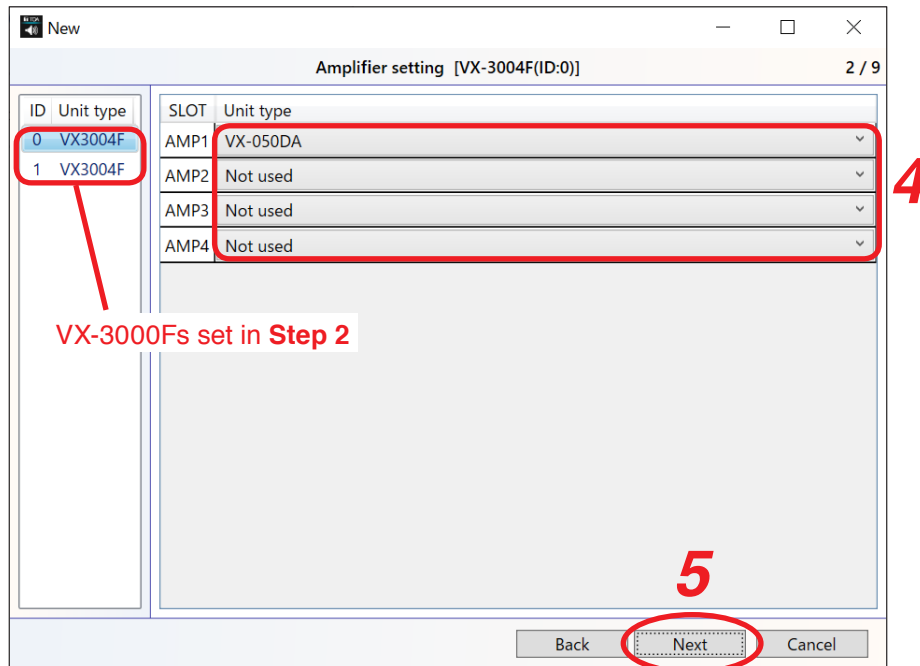

- Step 4.** Select the model of the digital power amplifier module for each VX-3000F's slot.  
Select the VX-3000F unit on the left side of the screen and the model of the digital power amplifier module on the right side.

**[In the case of AMP 1]**

Available Settings	[When "Power supply voltage specification" is set to "230 V"] Not used, VX-015DA, VX-030DA, VX-050DA (default) [When "Power supply voltage specification" is set to "100 V"] Not used, VX-012DA-2, VX-024DA-2, VX-036DA-2 (default)
--------------------	--

**[In the case of slot other than AMP 1]**

Available Settings	[When "Power supply voltage specification" is set to "230 V"] Not used (default), VX-015DA, VX-030DA, VX-050DA [When "Power supply voltage specification" is set to "100 V"] Not used (default), VX-012DA-2, VX-024DA-2, VX-036DA-2
--------------------	--

- Step 5.** Click the Next button.  
The "Settings for audio input" window is displayed.

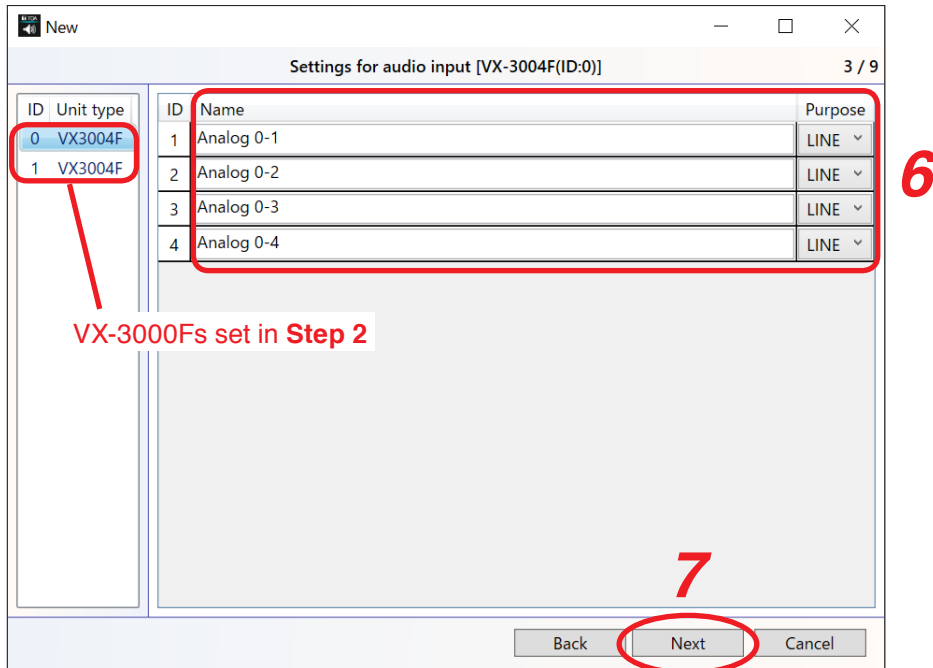

- Step 6.** Set the VX-3000F's audio input.  
Select the VX-3000F unit on the left side of the screen and set the name and purpose on the right side.

**(1) Name**

Enter each name of the input channels.

Available Settings

Up to 32 alphanumeric characters (Default name: for example, Analog 0-1 represents the input channel No. 1 of the VX-3000F of ID No. 0.)

**(2) Purpose**

Set the input level of the audio signal.

Available Settings

LINE (default), MIC

- Step 7.** Click the Next button.  
The "Audio output name setting" window is displayed.

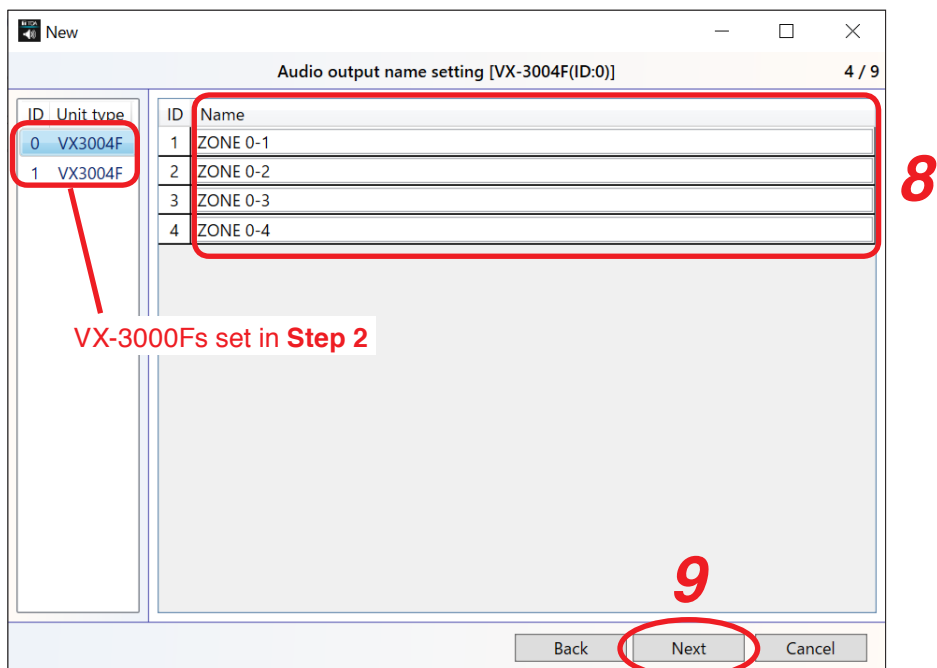

**Step 8.** Set the audio output of the VX-3000F.

Select the VX-3000F unit on the left side of the screen and set the name on the right side.

**Name**

Enter each name of the output channels.

Available Settings	Up to 32 alphanumeric characters (Default name: for example, ZONE 0-1 represents the Zone 1 output of the VX-3000F of ID No. 0.)
--------------------	--

**Step 9.** Click the Next button.

The "Terminal name setting" window is displayed.

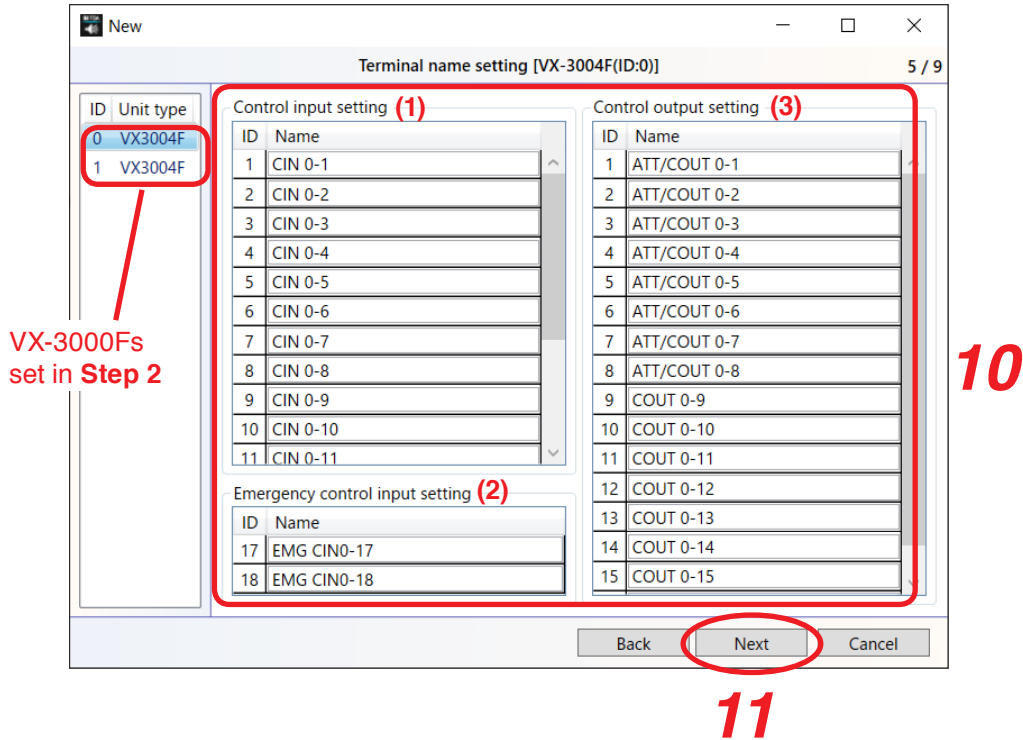
**Step 10.** Set the name of each terminal.

Select the VX-3000F unit on the left side of the screen and set the name on the right side.

**(1) Control input setting****• Name**

Enter each name of the control inputs.

Available Settings	Up to 32 alphanumeric characters (Default name: for example, CIN 0-1 represents Pin 1 of the control input terminal 1 of the VX-3000F of ID No. 0.)
--------------------	---

**(2) Emergency control input setting****• Name**

Enter each name of the emergency control inputs.

Available Settings	Up to 32 alphanumeric characters (Default name: for example, EMG CIN 0-17 represents Pins 1 and 2 of the emergency control input terminal of the VX-3000F of ID No. 0.)
--------------------	---

**(3) Control output setting****• Name**

Enter each name of the control outputs.

Available Settings	Up to 32 alphanumeric characters (Default name: for example, COUT 0-1 represents the control output terminal 1 of the VX-3000F of ID No. 0.)
--------------------	--

- Step 11.** Click the Next button.  
The "RM Configuration" window is displayed.

VX-3000Fs set in Step 2

12

13

ID	Unit type	Name	Extension switch number
0	VX3004F		
1	VX3004F		

RS-LINK A			
ID	Unit type	Name	Extension switch number
0	Not set		
1	Not set		
2	Not set		
3	Not set		

RS-LINK B			
ID	Unit type	Name	Extension switch number
4	Not set		
5	Not set		
6	Not set		
7	Not set		

Back Next Cancel

- Step 12.** Set the RM (Remote control microphone) configuration.  
Select the VX-3000F unit on the left side of the screen and set the configuration of the remote microphone on the right side.

### (1) Unit type

Select the model number of the remote microphone.

Available Settings	Not set (default), RM-200SF, RM-300X
--------------------	--------------------------------------

### (2) Name

When "RM-200SF" or "RM-300X" is set to "Unit type," this item becomes active to enter.  
Enter a name of the RM-200SF or RM-300X.

Available Settings	Up to 32 alphanumeric characters (Default name: for example, VX0-RM0 represents the RM-200SF or RM-300X of ID No. 0 connected to the VX-3000F of ID No. 0.)
--------------------	---

### (3) Extension switch number

When "RM-200SF" or "RM-300X" is set to "Unit type," this item becomes active to enter.  
Set the number of the extension units connected for extending the number of switches.

Available Settings	When "Unit type" is set to "RM-200SF": 0 (default) to 4 When "Unit type" is set to "RM-300X": 0 (default) to 7
--------------------	---

**Step 13.** Click the Next button.

- 13-1.** When "RM-200SF" or "RM-300X" is set to "Unit type" in **Step 12**  
The "RM key name setting" window is displayed.  
Proceed to **Step 14**.

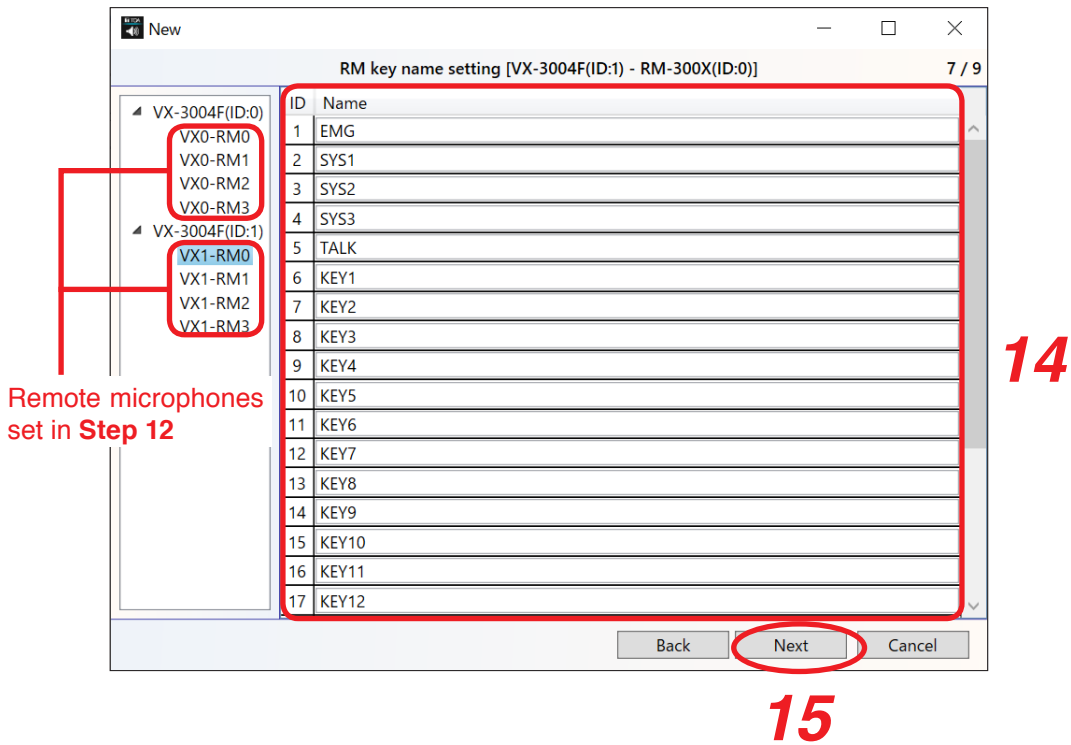

- 13-2.** When all remote microphones are set to "Not set" in **Step 12**  
The screen below is displayed.  
Proceed to **Step 18**.

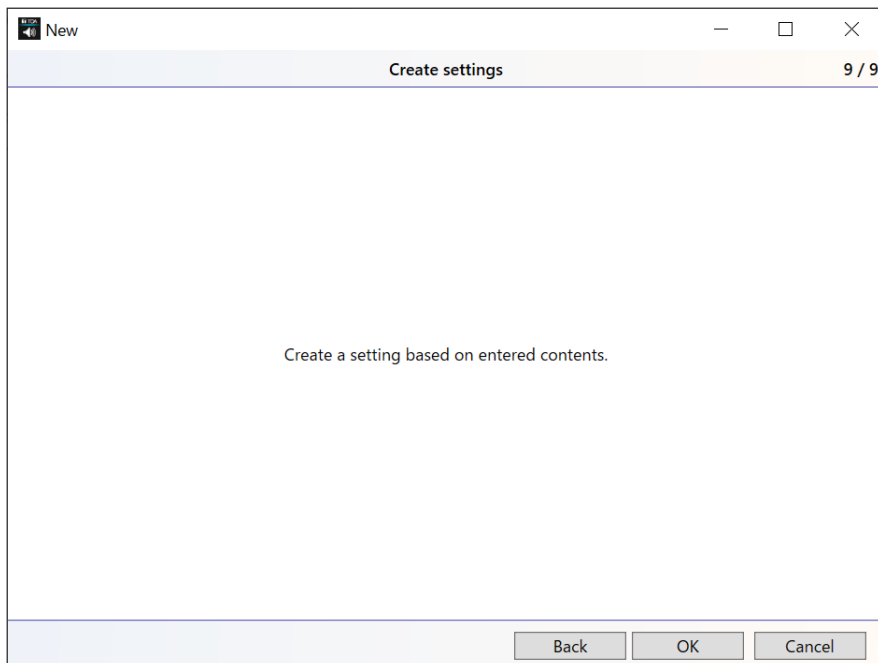

**Step 14.** Perform remote microphone's key name setting.

Select the remote microphone on the left side of the screen and set the name on the right side. Enter each name of the emergency/emergency warning key and function keys on the RM-200SF's or RM-320F's front panel, or of the covered key and function keys on the RM-300X's or RM-210F's top panel.

Available Settings	Up to 32 alphanumeric characters
--------------------	----------------------------------

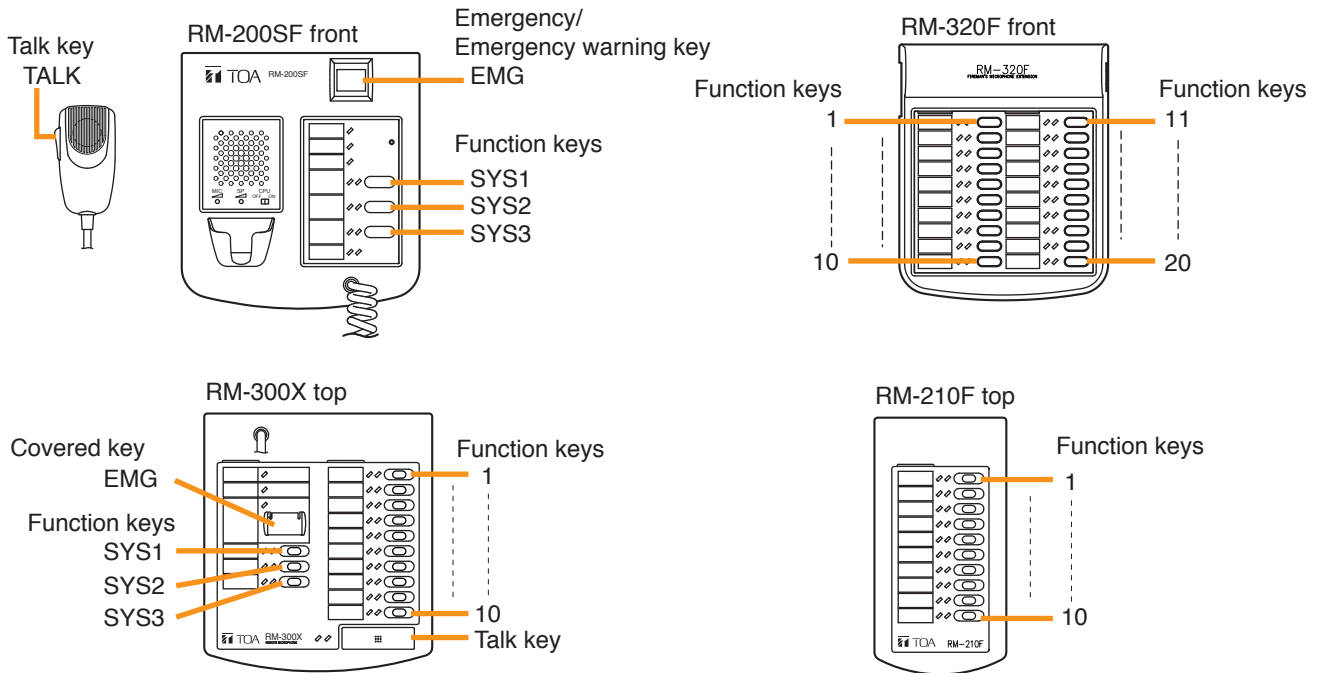

**Step 15.** Click the Next button.

The "TALK" window is displayed.

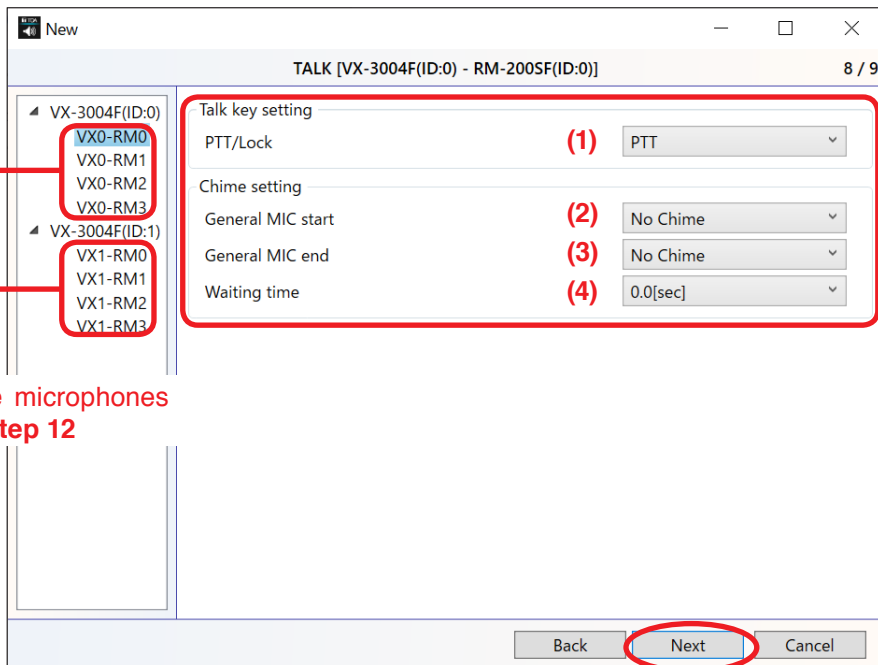

Remote microphones set in Step 12

16

17

**Step 16.** Perform the settings related to the remote microphone's talk key and the chime.  
Select the remote microphone on the left side of the screen and perform settings related to the talk key and the chime on the right side.

### (1) PTT/Lock

When the "Unit type" is set to "RM-200SF," talk key operation method is fixed to "PTT."  
When the "Unit type" is set to "RM-300X," select the operation method of talk key.

Available Settings	PTT (default) , Lock
--------------------	----------------------

#### [PTT and Lock]

Two different methods are available for talk key operation: Press-to-Talk (PTT) and Lock modes.

PTT: Enables microphone announcements to be made while the talk key is being pressed.

Lock: Enables microphone announcements by pressing the talk key once and terminates by pressing it again.

### (2) General MIC start

Select the chime tone at the start of general microphone announcement.

Available Settings	No chime (default), Chime 1, Chime 2, Chime 3, Chime 4, Ascending 4-note tone, Descending 4-note tone, 2-tone chime, Gong
--------------------	---

The system chime is set as follows.

- Chime 1: Ascending 4-note tone
- Chime 2: Descending 4-note tone
- Chime 3: 2-tone chime
- Chime 4: Gong

### (3) General MIC end

Select the chime tone at the end of general microphone announcement.

Available Settings	No chime (default), Chime 1, Chime 2, Chime 3, Chime 4, Ascending 4-note tone, Descending 4-note tone, 2-tone chime, Gong
--------------------	---

### (4) Waiting time

Set the time required to start broadcast\* after the talk key on the remote microphone has been pressed. Select the duration according to the start-up time of the connected external power amplifiers.

\* When "No chime" is selected for the start of remote microphone announcement, wait time means time duration before the microphone announcement starts, while when a system chime other than "No chime" is selected, it means the time duration before the chime sounds.

Available Settings	0, 0.5, 1, 1.5, 2, 3, 4 [sec] (default: 0)
--------------------	--

- Step 17.** Click the Next button.  
The following window is displayed.

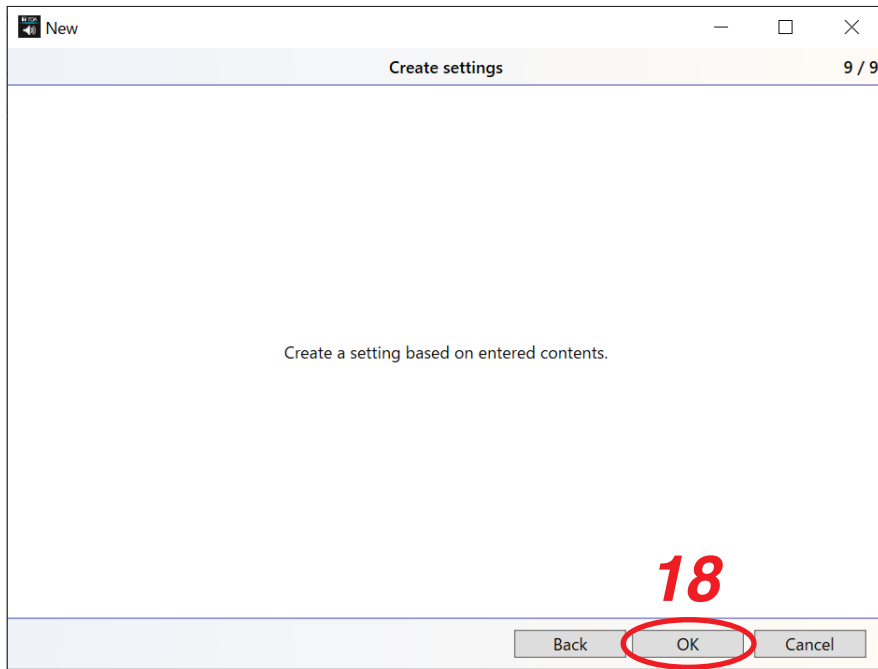

- Step 18.** Click the OK button.  
Setting is created based on the entered contents.

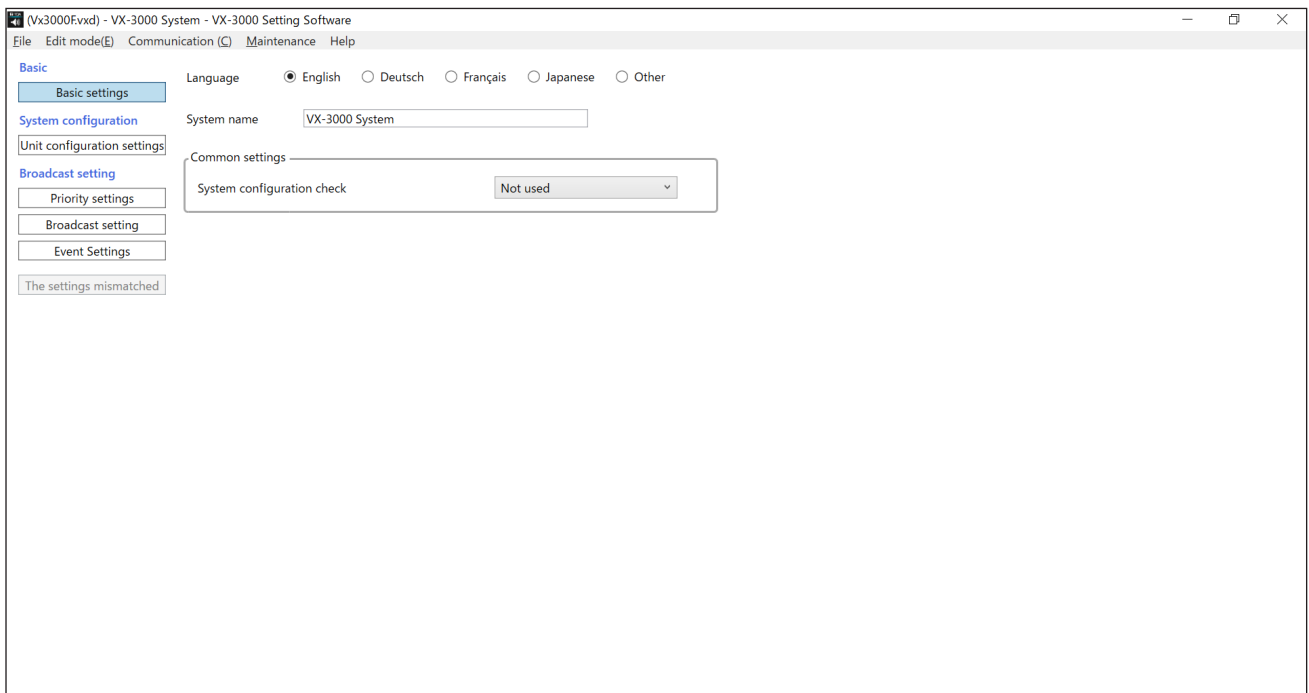

## 6. BASIC SETTINGS

Clicking the Basic settings button displays the screen below.

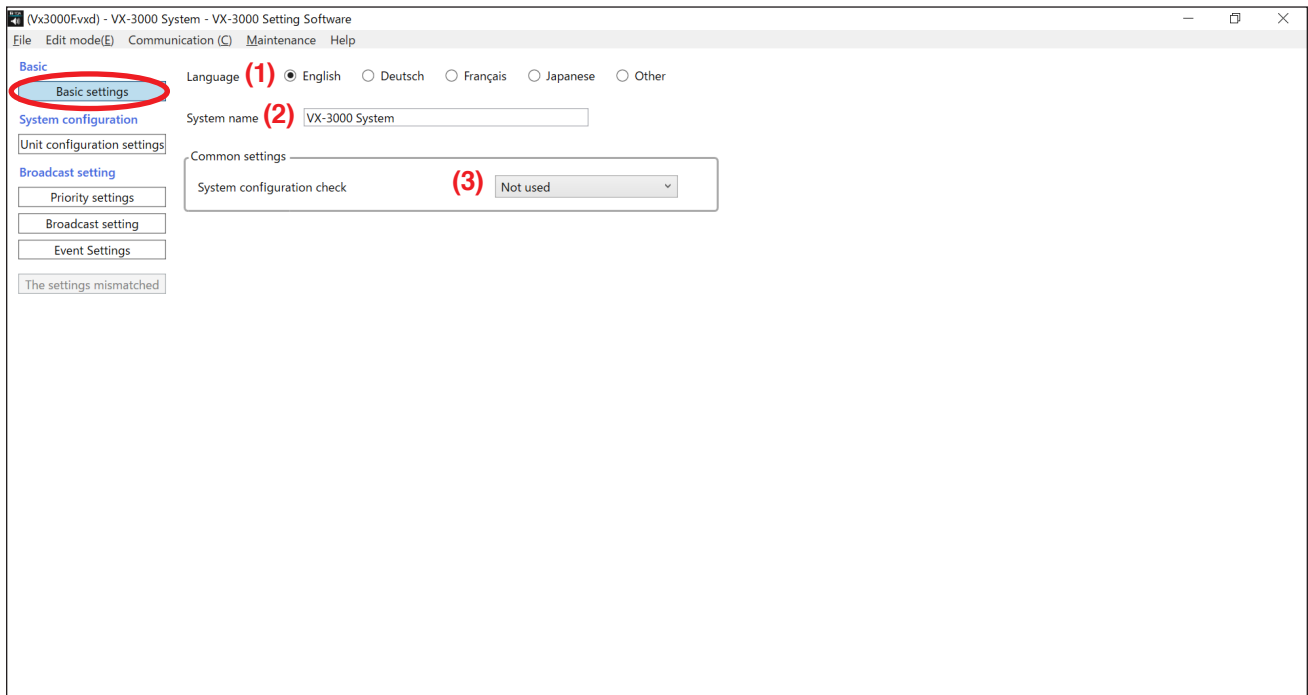

### (1) Language

Select the language to use.

Available Settings	English (default), Deutsch, Français, Japanese, Other
--------------------	---

#### Note

"Other" language can be set freely according to your needs.  
Contact your nearest TOA dealer regarding the setting method.

### (2) System name

Enter the system name.

Available Settings	Up to 32 alphanumeric characters*
--------------------	-----------------------------------

\* Following symbols can also be used.

! " # \$ % & ' ( ) = ~ | - ^ \ @ [ ; : ] , . / ` { + \* } > ? \_

### (3) System configuration check

Set whether or not to perform the connection state confirmation among the VX-3000F, RM-200SF, and RM-300X of the failure detection function.

Available Settings	Not used (default), Used
--------------------	--------------------------

#### Note

In the Simple mode, only the connection state confirmation of the failure detection function can be used, but other items of the function not.

## 7. UNIT CONFIGURATION SETTINGS

Clicking the Unit configuration settings button displays the screen below.  
You can confirm and change the contents set using the new creation wizard.

### Note

When an equipment is added on this screen, automatic registration\* is not performed though executed when the unit configuration is set using the new creation wizard.

Perform the necessary settings in "Broadcast setting" and "Event settings."

\* Settings of "General broadcast" and "Control output" in the "Broadcast setting" and those of "Control input" and "RM" in the "Event settings."

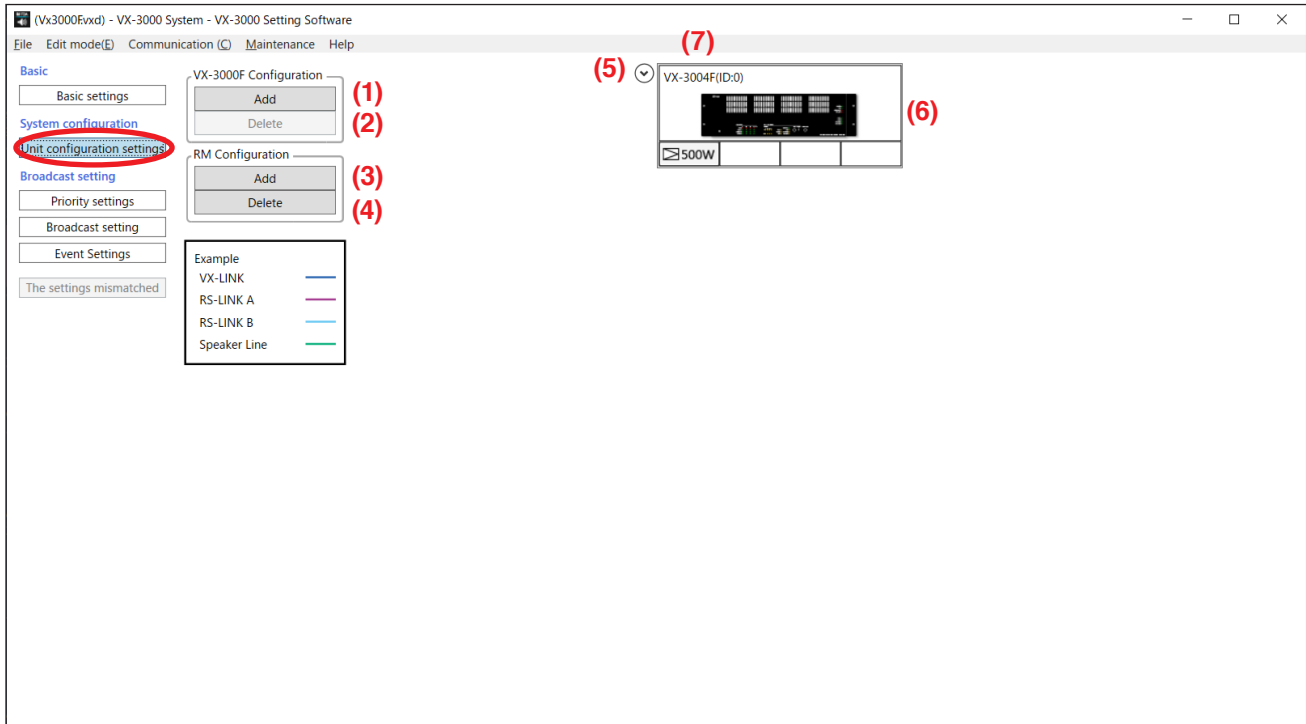

### (1) VX-3000F Configuration: Add

Adds the VX-3000F to the unit configuration. (See p. 2-20.)

### (2) VX-3000F Configuration: Delete

Deletes the designated VX-3000F from the configuration. (See p. 2-22.)

### (3) RM Configuration: Add

Adds the remote microphone to the unit configuration. (See p. 2-22.)

### (4) RM Configuration: Delete

Deletes the designated remote microphone from the configuration. (See p. 2-23.)

### (5) VX-3000F configuration detail display button

You can confirm the details of the unit connected to the VX-3000F. (See p. 2-21.)

### (6) Component icon

Shows the unit registered as component.

### (7) VX-3000F's name

Shows the name of the VX-3000F.

## 7.1. Adding the VX-3000F to the Unit Configuration

Clicking the [VX-3000F Configuration: Add] button pops up the "Registration of VX-3000F units" window. Perform settings of the VX-3000F to be added to the unit configuration. Set contents are different for each model. Up to 40 units in total of 3 models can be used.

[When adding the VX-3004F]

(1) Unit type  
 VX-3004F  VX-3008F  VX-3016F

(2) Amplifier setting

SLOT	Unit type
AMP1	VX-050DA
AMP2	Not used
AMP3	Not used
AMP4	Not used

(3) Selected unit  Add sets

[When adding the VX-3008F]

(1) Unit type  
 VX-3004F  VX-3008F  VX-3016F

(2) Amplifier setting

SLOT	Unit type
AMP1	VX-050DA
AMP2	Not used

(3) Selected unit  Add sets

[When adding the VX-3016F]

(1) Unit type  
 VX-3004F  VX-3008F  VX-3016F

(2) Amplifier setting

SLOT	Unit type
AMP1	VX-050DA

(3) Selected unit  Add sets

Set the items below and click the OK button. Then, the unit designated in the Unit type (1) is added in the Unit configuration display on the Unit configuration settings screen by the number of units entered in the "Selected unit # Add set" (3).

### (1) Unit type

Select the model number.

If you change the model by clicking the radio button, the display of the set contents changes accordingly.

### (2) Amplifier setting

Perform settings of the built-in digital power amplifier module used for each channel.

### (3) Selected unit # Add set

Set the number of the VX-3000F units to be added to the configuration with the above set contents.

Click the OK button after entering the number of the units. Then, the unit(s) are added in the equipment configuration field on the right side of the menu, and the "Registration of VX-3000F units" window will be closed.

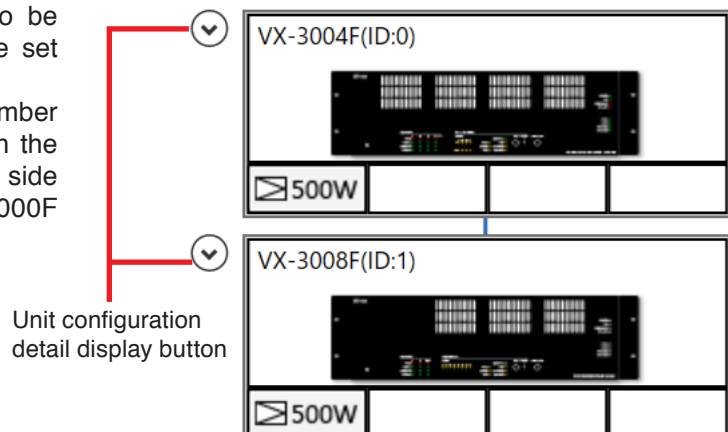

### • Unit configuration detail display button

You can confirm the details of the unit configuration when you click the "v" button (unfold button) on the left side of the Unit icon.

Click the "∧" button (fold button) on the upper left to close the screen.

You can perform detailed settings by clicking each frame of the detail display in the same way when you click the component icon.

Frames corresponding to the setting screens are as follows.

Frame of power amplifier or model No./ID: VX configuration setting

Frame of audio input: Setting for audio input

Frame of speaker output: Setting for audio output

You can also perform detailed settings of the control input/output on the screen displayed by clicking the above each icon or frame.

VX-3004F(ID:0)

VX configuration setting Settings for audio input Settings for audio output Settings for terminals

Unit type  
 VX-3004F  VX-3008F  VX-3016F

Amplifier setting

SLOT	Unit type
AMP1	VX-050DA
AMP2	Not used
AMP3	Not used
AMP4	Not used

OK Cancel

Also, when you click the frame of the remote microphone displayed in black, the RM config screen for detailed settings of the remote microphone appears. (Even if you click the frame with gray characters, this operation is invalid because no remote microphone connection setting is made.)

RM-200SF(ID:0)

RM configuration setting TALK

RM setting

Name VX0-RM0

Unit type RM-200SF

Extension switch number 1

Name setting RS-LINK A(ID:0)

	Name
EMG	EMG
SYS1	SYS1
SYS2	SYS2
SYS3	SYS3
TALK	TALK
1	KEY1
2	KEY2
3	KEY3
4	KEY4
5	KEY5
6	KEY6
7	KEY7
8	KEY8
9	KEY9
10	KEY10
11	KEY11
12	KEY12

OK Cancel

## 7.2. Deleting the VX-3000F from the Unit Configuration

Clicking the [VX-3000F Configuration: Delete] button pops up the "Delete of VX-3000F units" window, which displays a list of the VX-3000F units included in the configuration.

### Note

The unit with "ID: 0" cannot be deleted.

The VX-3000F set to "ID: 0" must be included in the unit configuration.

Check the checkbox for the VX-3000F to be deleted, then click the OK button.

The unit will be deleted from the equipment configuration field, and the "Delete of VX-3000F units" window will be closed.

## 7.3. Adding the Remote Microphone to the RM Configuration

Clicking the [RM Configuration: Add] button pops up the "Registration of RM" window.

Perform settings for the Remote microphone to be connected to the VX-3000F.

### (1) Unit type

Select the model number of the remote microphone.

### (2) Extension switch number

Set the number of the extension units connected for extending the number of switches.

Available Settings	When "Unit type" is set to "RM-200SF": 0 (default) to 4 When "Unit type" is set to "RM-300X": 0 (default) to 7
--------------------	---

### (3) Connected unit

Designate the VX-3000F to which the target remote microphone is connected.

### (4) Connected connector

Designate the RS link terminal to which the target remote microphone is connected.

Available Settings	RS-LINK A (default), RS-LINK B
--------------------	--------------------------------

### (5) Selected unit # Add sets

Click the OK button after entering the number of the remote microphones. Then, the remote microphone(s) will be added to the VX-3000F designated in "Connected unit" (3), and the "Registration of RM" window will be closed.

## 7.4. Deleting the Remote Microphone from the RM Configuration

Clicking the [RM Configuration: Delete] button pops up the "Delete of RMs" window, which displays a list of the remote microphones included in the configuration.

Check the checkbox for the remote microphone to be deleted, then click the OK button. It will be deleted from the equipment configuration field, and the "Delete of RMs" window will be closed.

## 7.5. Setting the VX-3000F's Unit Configuration

Clicking the unit icon in the unit configuration display pops up the setting window for each unit.

SLOT	Unit type
AMP1	VX-050DA
AMP2	Not used
AMP3	Not used
AMP4	Not used

### 7.5.1. VX configuration setting

Clicking the VX configuration setting tab displays the window as shown below.

Make the setting in the same way as the amplifier setting (p. 2-10) made using the new creation wizard.

SLOT	Unit type
AMP1	VX-050DA
AMP2	Not used
AMP3	Not used
AMP4	Not used

OK Cancel

### 7.5.2. Audio input setting

Clicking the Settings for audio input tab displays the window as shown below.

Make the setting in the same way as the audio input setting (p. 2-11) made using the new creation wizard.

	Name	Purpose
AUDIO IN1	Analog 0-1	LINE
AUDIO IN2	Analog 0-2	LINE
AUDIO IN3	Analog 0-3	LINE
AUDIO IN4	Analog 0-4	LINE

OK Cancel

### 7.5.3. Audio output setting

Clicking the Settings for audio output tab displays the window as shown below.

Make the setting in the same way as the audio output setting (p. 2-12) made using the new creation wizard.

	Name
Zone1	ZONE 0-1
Zone2	ZONE 0-2
Zone3	ZONE 0-3
Zone4	ZONE 0-4

### 7.5.4. Terminal setting

Clicking the Settings for terminals tab displays the screen as shown below.

Make the setting in the same way as the terminal setting (p. 2-12) made using the new creation wizard.

Control input setting		
	Name	
1	CIN 0-1	
2	CIN 0-2	
3	CIN 0-3	
4	CIN 0-4	
5	CIN 0-5	
6	CIN 0-6	
7	CIN 0-7	
8	CIN 0-8	
9	CIN 0-9	
10	CIN 0-10	

Control output setting		
	Name	
1	ATT/COUT 0-1	
2	ATT/COUT 0-2	
3	ATT/COUT 0-3	
4	ATT/COUT 0-4	
5	ATT/COUT 0-5	
6	ATT/COUT 0-6	
7	ATT/COUT 0-7	
8	ATT/COUT 0-8	
9	COUT 0-9	
10	COUT 0-10	
11	COUT 0-11	
12	COUT 0-12	
13	COUT 0-13	
14	COUT 0-14	

Emergency control input setting		
	Name	
17	EMG CIN0-17	
18	EMG CIN0-18	

## 7.6. Setting the Remote Microphone Configuration

Clicking the remote microphone icon in the unit configuration detail display of the VX-3000F pops up the remote microphone configuration setting window.

RM-200SF(ID:0)

RM configuration setting TALK

RM setting

Name VX0-RM0

Unit type RM-200SF

Extension switch number 1

Name setting RS-LINK A(ID:0)

	Name
-	
EMG	EMG
SYS1	SYS1
SYS2	SYS2
SYS3	SYS3
TALK	TALK
1	KEY1
2	KEY2
3	KEY3
4	KEY4
5	KEY5
6	KEY6
7	KEY7
8	KEY8
9	KEY9
10	KEY10
11	KEY11
12	KEY12

OK Cancel

### 7.6.1. RM configuration setting

Clicking the RM configuration setting tab displays the screen as shown below.

Make the setting in the same way as the RM configuration setting (p. 2-13) and the RM key name setting (p. 2-15) made using the new creation wizard.

RM-200SF(ID:0)

RM configuration setting TALK

RM setting

Name VX0-RM0

Unit type RM-200SF

Extension switch number 1

Name setting RS-LINK A(ID:0)

	Name
-	
EMG	EMG
SYS1	SYS1
SYS2	SYS2
SYS3	SYS3
TALK	TALK
1	KEY1
2	KEY2
3	KEY3
4	KEY4
5	KEY5
6	KEY6
7	KEY7
8	KEY8
9	KEY9
10	KEY10
11	KEY11
12	KEY12

OK Cancel

### 7.6.2. TALK key setting

Clicking the TALK tab displays the screen as shown below.

Make the setting in the same way as the TALK setting (p. 2-16) made using the new creation wizard.

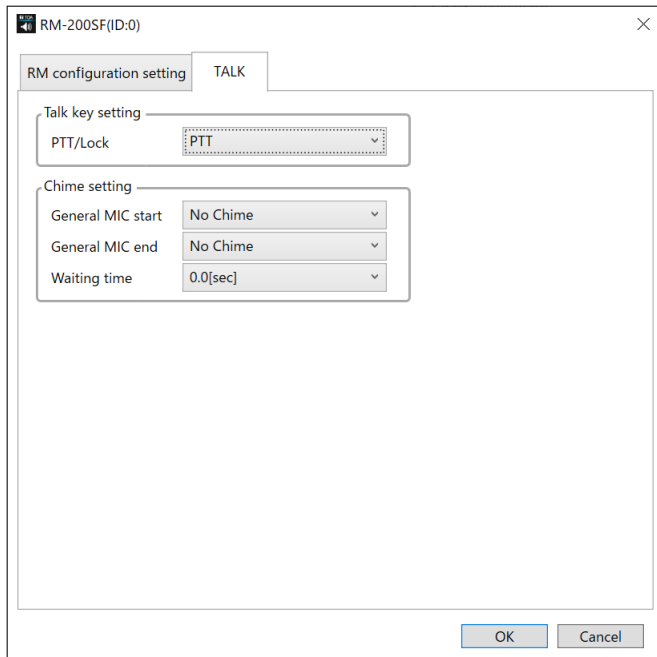

## 8. PRIORITY SETTINGS

Clicking the Priority settings button displays the screen below.  
Set input sound source priority levels.

[Display by One-time] button

The screenshot shows the 'VX-3000 Setting Software' interface. The 'Display by One-time' button is circled in red. The 'Priority settings' button is also circled in red. The screen displays three tables: Chime sound source, Audio In, and RM. Each table has columns for No., Equipment, Audio Source, Name, Type, Priority, and Same priority.

No.	Equipment	Audio Source	Name	Type	Priority	Same priority
1	VX-3004F(ID:0)	Input 1	Analog 0-1	General	600	Priority first
2	VX-3004F(ID:0)	Input 2	Analog 0-2	General	600	Priority first
3	VX-3004F(ID:0)	Input 3	Analog 0-3	General	600	Priority first
4	VX-3004F(ID:0)	Input 4	Analog 0-4	BGM	800	Priority first
5	VX-3004F(ID:1)	Input 1	Analog 1-1	General	600	Priority first
6	VX-3004F(ID:1)	Input 2	Analog 1-2	General	600	Priority first
7	VX-3004F(ID:1)	Input 3	Analog 1-3	General	600	Priority first
8	VX-3004F(ID:1)	Input 4	Analog 1-4	BGM	800	Priority first

No.	Equipment	Audio Source	Name	Type	Priority	Same priority
1	VX-3004F(ID:0)	RM-2005F(ID:0)	VX0-RM0	General	600	Priority first
2	VX-3004F(ID:0)	RM-2005F(ID:1)	VX0-RM1	General	600	Priority first
3	VX-3004F(ID:0)	RM-2005F(ID:2)	VX0-RM2	General	600	Priority first
4	VX-3004F(ID:0)	RM-2005F(ID:3)	VX0-RM3	General	600	Priority first

Sorting is possible by clicking the table title ("No.," "Equipment," etc.) in the unfolded display.  
Click the "A" button (fold button) at the left of each sound source field to fold the display.

The screenshot shows the 'VX-3000 Setting Software' interface with the tables folded. The 'Display by One-time' button is visible. The 'Priority settings' button is also visible. The screen displays three collapsed sections: Internal EV, Chime sound source, Audio In, and RM.

Clicking the leftmost "v" button (unfold button) of each sound source frame unfolds the display, allowing you to perform settings and confirmation.

If you click the [Display by One-time] button, you can perform setting and confirmation in a list view. Sorting is also possible by clicking the title such as "No." and "Equipment" of the table in the list display. To return to the original display for each sound source, click the [Display by Individual] button.

[Display by Individual] button

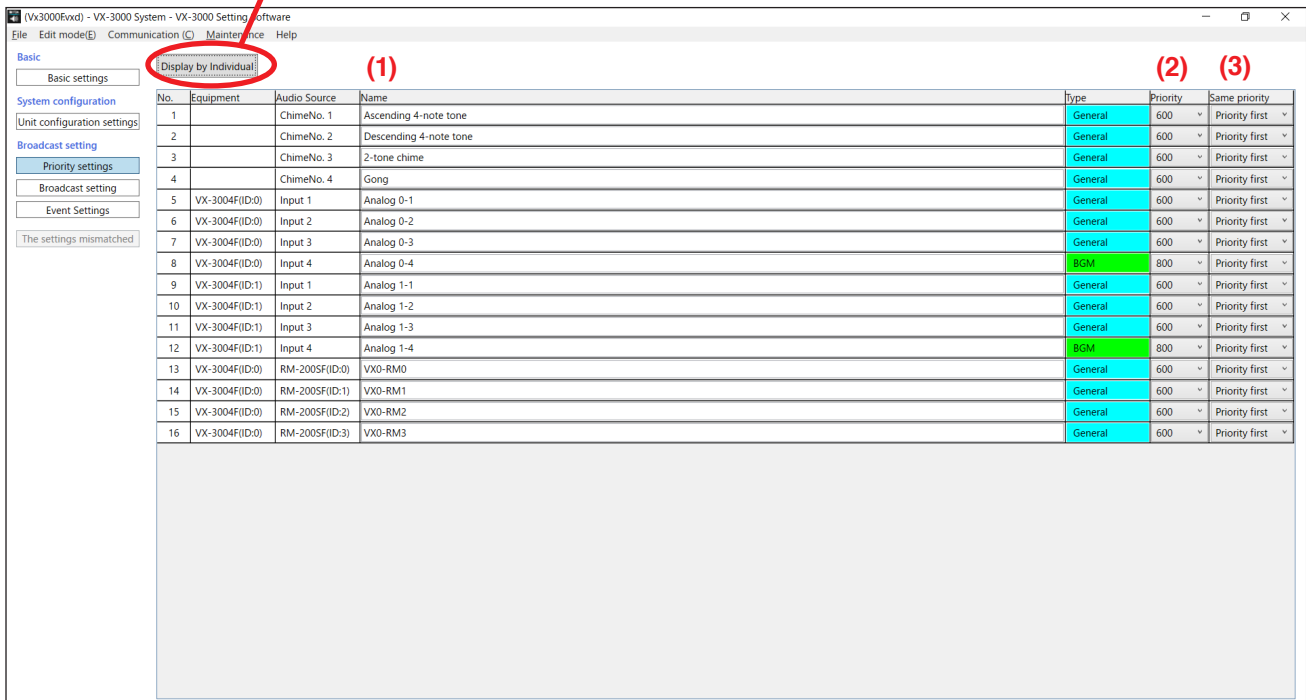

### (1) Name

Names of the Audio inputs, Remote microphones, and sound source files can be changed.

Available Settings	Up to 32 alphanumeric characters (Default: Name set in each setting like Audio input setting)
--------------------	---

### (2) Priority

Select priority levels. The smaller the number, the higher the priority level. The priority range that can be set varies depending on the types of the sound sources.

Type	Priority	Default
General	513 – 1024	600
BGM	513 – 1024	800

- General: General-purpose pattern broadcasts from the VX-3000F's audio inputs 1 through 3 and microphone announcements from the remote microphone.
- BGM: General-purpose pattern broadcasts from the V-3000F's audio input 4 and broadcasts from the remote microphone's AUX input.

#### Notes

- General-purpose sound sources and BGM sound sources are mixed when the BGM sound source is assigned to the general-purpose pattern broadcast. Volume level of the BGM sound sources cannot be attenuated in the Simple mode.
- The priority levels set for BGM sources take effect when the BGM sources are assigned to general-purpose broadcast patterns. When the BGM sources are assigned to general/BGM broadcasts, their priority levels are made lowest in the system irrespective of their set priority levels.

**(3) Same priority**

Select how to assign priority among multiple input sound sources all set to the same priority level.

**Note**

The control type cannot be set differently for individual sound sources. The control type can be set differently for individual priority level.

Available Settings	Priority last, Priority first (default)
--------------------	---

**[When set to Priority last (LIFO)]**

- Broadcast not possible to zones where a sound source with a higher priority is already broadcasting.
- Broadcasts to zones where a sound source with the same priority is already broadcasting will interrupt and override that broadcast. The original broadcast will resume once the priority broadcast has finished.
- Broadcasts to zones where a sound source with a lower priority is already broadcasting will interrupt and override that lower priority broadcast. The original broadcast will resume once the priority broadcast has finished.

**[When set to Priority first (FIFO)]**

- Broadcast not possible to zones where a sound source with a higher priority is already broadcasting.
- Broadcast not possible to zones where a sound source with the same priority is already broadcasting.
- Broadcasts to zones where a sound source with a lower priority is already broadcasting will interrupt and override that lower priority broadcast. The original broadcast will resume once the priority broadcast has finished.

## 9. BROADCAST SETTING

Clicking the Broadcast setting button displays the screen below.

Set the combination of the input sound source and the output destination of the general broadcast, and the control output group to be activated in synchronization with the broadcast activation.

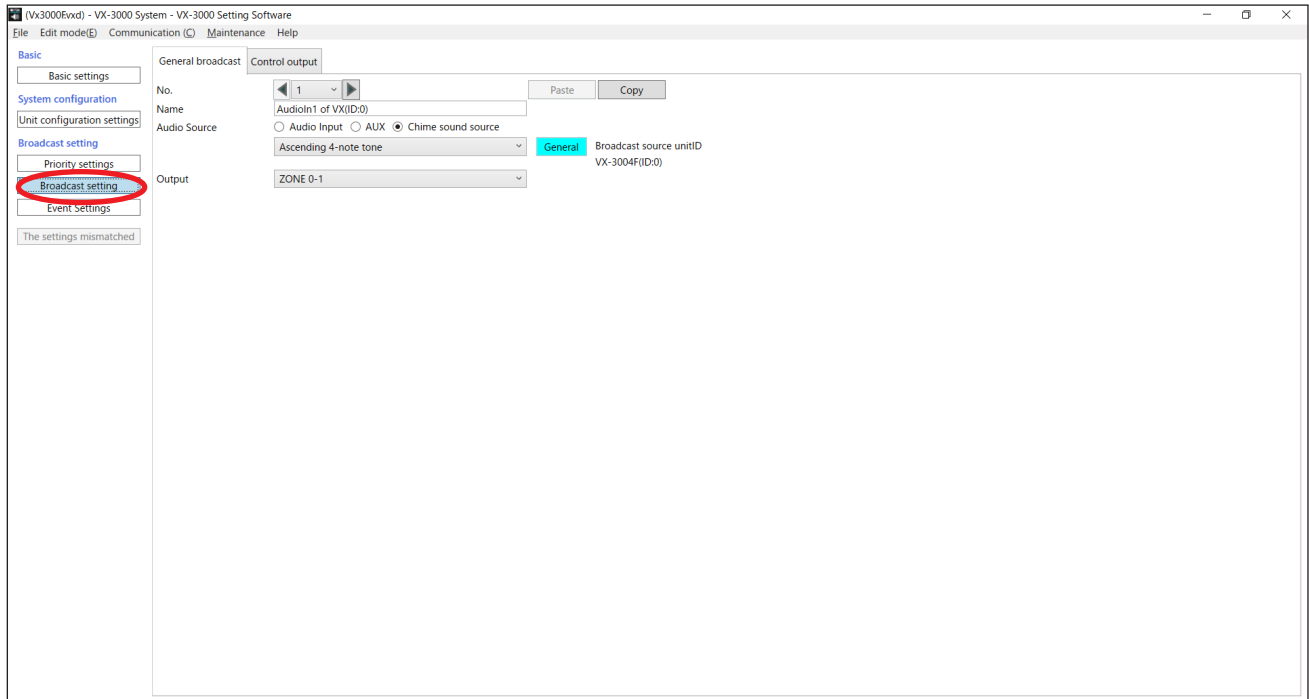

### 9.1. General Broadcast Setting

When you click the General broadcast tab on the broadcast setting screen, you can set the combination of the input sound source and output destination (general broadcast pattern) of the general broadcast. The setting items differ depending on the sound source type (general broadcast or BGM broadcast).

All sound sources are numbered in the order shown below and output to all zones by default.

Also, the chime sound sources are subsequently numbered after the last numbered device input in the order as shown below.

1. Audio input of the VX-3000F (ID: 0)
  2. AUX input of the remote microphone connected to the VX-3000F (ID: 0)
  3. Audio input of the VX-3000F (ID: 1)
  4. AUX input of the remote microphone connected to the VX-3000F (ID: 1)
- ⋮
- ⋮
- Ascending 4-note tone
- Descending 4-note tone
- 2-tone chime
- Gong

### 9.1.1. Sound source-related setting for the general-purpose pattern broadcast

The sound source type of the VF-3000F's audio inputs 1 through 3 and the chime sound source is preset to "General," enabling it to be used for the general-purpose pattern broadcast.

Shown below are the setting items when the VX-3000F's audio inputs 1 through 3 or the chime sound source are selected as sound source inputs.

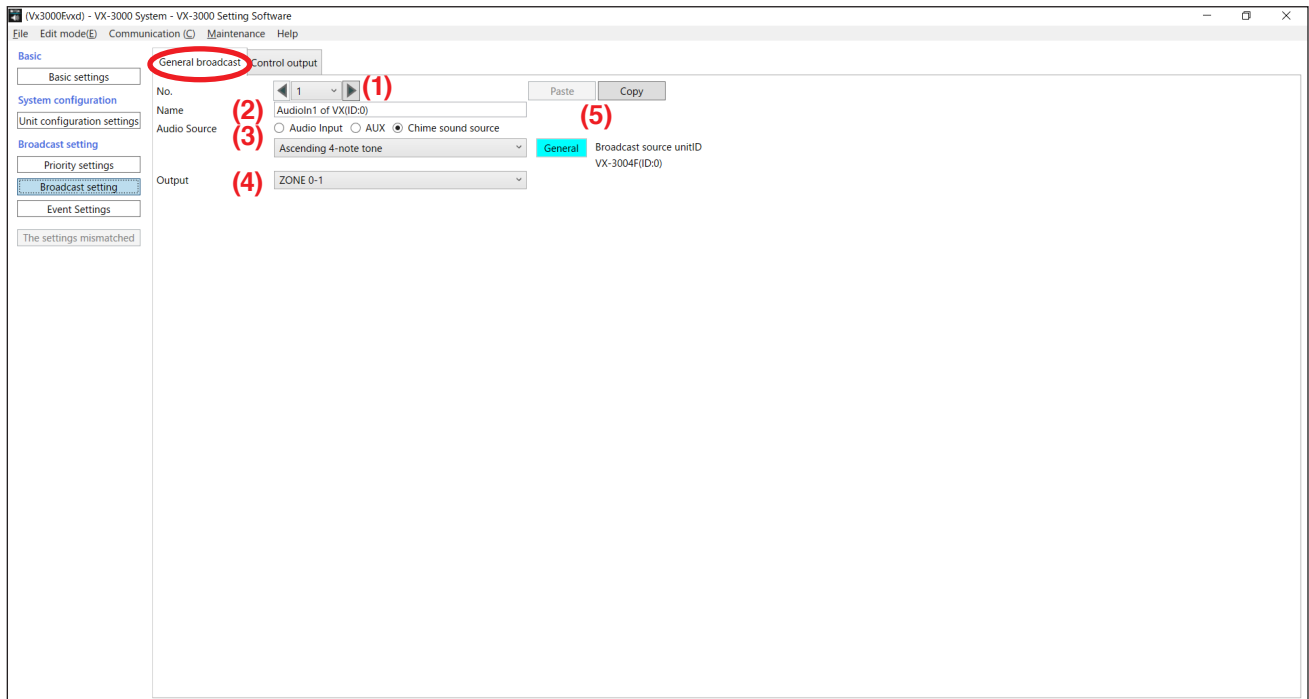

#### (1) No.

Click the box or the arrow buttons to select the general broadcast pattern number.

Available Settings	1 – 1024 (default: 1)
--------------------	-----------------------

#### (2) Name

Enter the name of the general broadcast pattern.

Available Settings	Up to 32 alphanumeric characters
--------------------	----------------------------------

For example, the VX-3000F (ID: 0)'s audio input 1 is named as "Audioln1 of VX(ID:0)" by default.

#### (3) Audio source

When the sound source is audio input, select "Audio Input" with a radio button, then the VX-3000F's audio inputs 1 through 3 from the pull-down list.

When the sound source is chime, select "Chime sound source" with a radio button, then the chime sound source from the pull-down list. When the sound source is chime, the ID of the broadcast origin unit is displayed at right.

Available Settings	None (default), Set audio source name
--------------------	---------------------------------------

#### (4) Output

Select the general broadcast output zones.

Available Settings	None (default), ALL, Set individual zone names
--------------------	--

#### (5) Copy and Paste buttons

Clicking the Copy button copies all of the on-screen settings except "Name" (2) preset by default.

Select another general broadcast pattern number. Then, clicking the Paste button pastes the copied parameters in the setting screen of the selected by "No." (1).

### 9.1.2. Sound source-related setting for BGM broadcast

The sound source type of the VF-3000F's audio input 4 and the remote microphone's AUX input is preset to "BGM," enabling it to be used for BGM broadcast.

Shown below are the setting items when the VX-3000F's audio input 4 or the remote microphone's AUX input are selected as a sound source input.

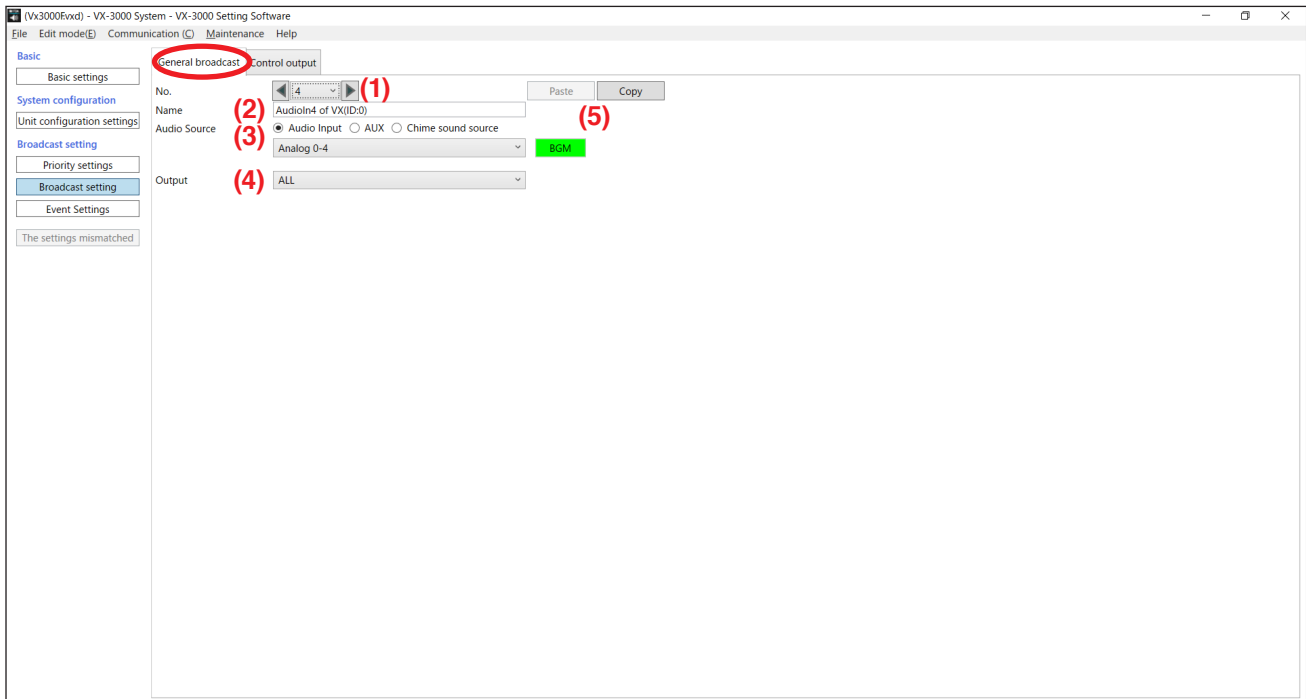

#### (1) No.

Click the box or the arrow buttons to select the general broadcast pattern number.

Available Settings	1 – 1024 (default: 1)
--------------------	-----------------------

#### (2) Name

Enter the name of the general broadcast pattern.

Available Settings	Up to 32 alphanumeric characters
--------------------	----------------------------------

For example, the AUX input of the remote microphone (ID: 1) connected to the VX-3000F (ID: 0) is named as "AUX of VX(ID:0)-RM(ID:1)" by default.

#### (3) Audio source

In the case of the VX-3000F's audio input, select "Audio Input" with a radio button, then the VX-3000F's audio input 4 from the pull-down list.

In the case of the remote microphone's AUX input, select "AUX" with a radio button, then the remote microphone from the pull-down list.

Available Settings	None (default), Set audio source name
--------------------	---------------------------------------

#### (4) Output

Select the general broadcast output zones.

Available Settings	None (default), ALL, Set output zone (Individual)
--------------------	---

#### (5) Copy and Paste buttons

Clicking the Copy button copies all of the on-screen settings except "Name" (2) preset by default.

Select another general broadcast pattern number. Then, clicking the Paste button pastes the copied parameters in the setting screen of the selected by "No." (1).

## 9.2. Control Output Setting

The control output group can be set.

Clicking the Control output tab on the Broadcast setting screen enables the control output group (control output pattern) to be set.

Each control output is registered as 1 control output pattern by default.

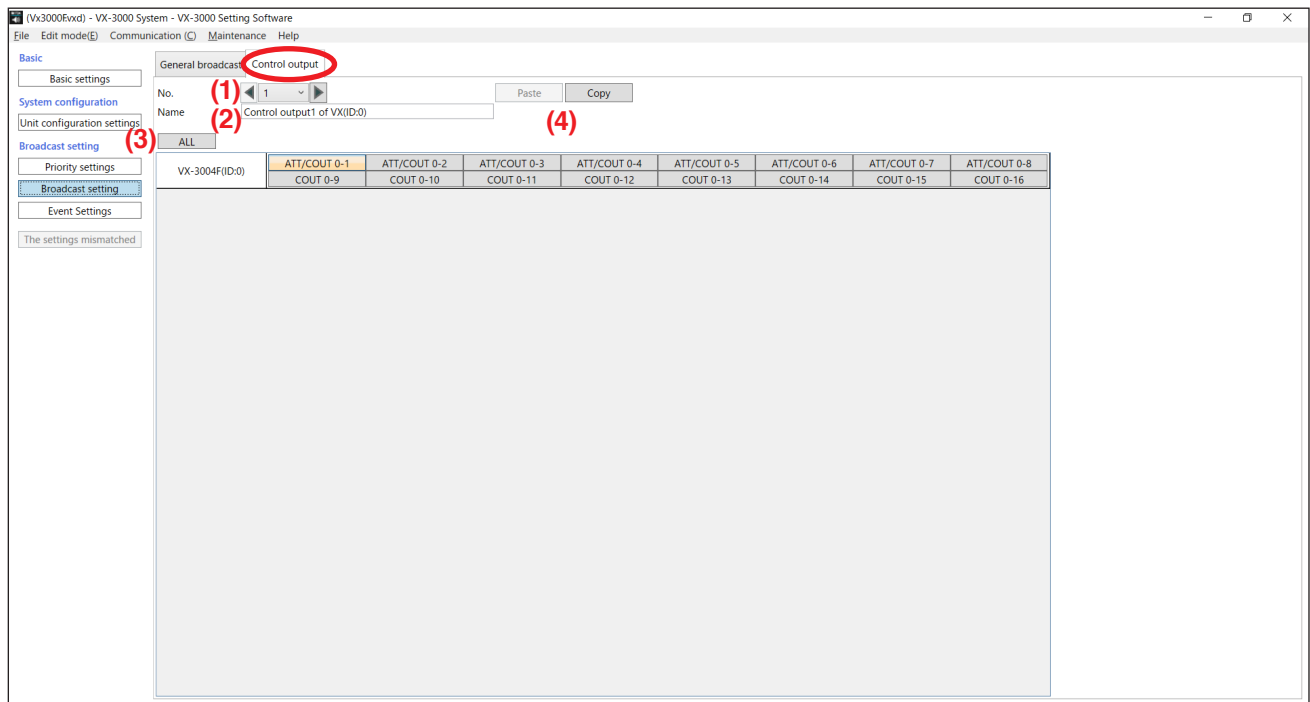

### (1) No.

Click the box or the arrow buttons to select the control output pattern number.

Available Settings	1 – 1024 (default: 1)
--------------------	-----------------------

### (2) Name

Enter the name of the control output pattern.

Available Settings	Up to 32 alphanumeric characters
--------------------	----------------------------------

For example, the VX-3000F (ID: 0)'s control output 1 is named as "Control output1 of VX(ID:0)" by default.

**(3) Control output ON/OFF buttons**

Select the control output terminals to perform control.

Available Settings	On (orange), Off (gray)
--------------------	-------------------------

**Tips**

ALL button

ALL	ATT/COU 0-1 COUT 0-9	ATT/COU 0-2 COUT 0-10	ATT/COU 0-3 COUT 0-11	ATT/COU 0-4 COUT 0-12	ATT/COU 0-5 COUT 0-13	ATT/COU 0-6 COUT 0-14	ATT/COU 0-7 COUT 0-15	ATT/COU 0-8 COUT 0-16
VX-3004F(ID:0)								
VX-3008F(ID:1)	ATT/COU 1-1 COUT 1-9	ATT/COU 1-2 COUT 1-10	ATT/COU 1-3 COUT 1-11	ATT/COU 1-4 COUT 1-12	ATT/COU 1-5 COUT 1-13	ATT/COU 1-6 COUT 1-14	ATT/COU 1-7 COUT 1-15	ATT/COU 1-8 COUT 1-16
VX-3016F(ID:2)	ATT/COU 2-1 COUT 2-17	ATT/COU 2-2 COUT 2-18	ATT/COU 2-3 COUT 2-19	ATT/COU 2-4 COUT 2-20	ATT/COU 2-5 COUT 2-21	ATT/COU 2-6 COUT 2-22	ATT/COU 2-7 COUT 2-23	ATT/COU 2-8 COUT 2-24

Model cells

Individual control output cells

- When a cell of the individual control outputs is clicked, its control output is selected. The control output alternates between ON and OFF each time the cell is clicked.
- When the Model cell is clicked, all control outputs of its model are selected. All control outputs of the selected model alternate between On and Off each time the Model cell is clicked.
- When the ALL button is clicked, all control outputs of the VX-3000 system are selected. All control outputs alternate between ON and OFF each time the ALL button is clicked.

**(4) Copy and Paste buttons**

Clicking the Copy button copies all of the on-screen settings except "Name" (2) preset by default.

Select another control output pattern number. Then, clicking the Paste button pastes the copied parameters in the setting screen of the selected "No." (1).

## 10. EVENT SETTINGS

When the Event Settings button is clicked, the screen below is displayed.

The functions related to the broadcast start can be assigned to the VX-3000F's control input terminals and the remote microphone's function keys.

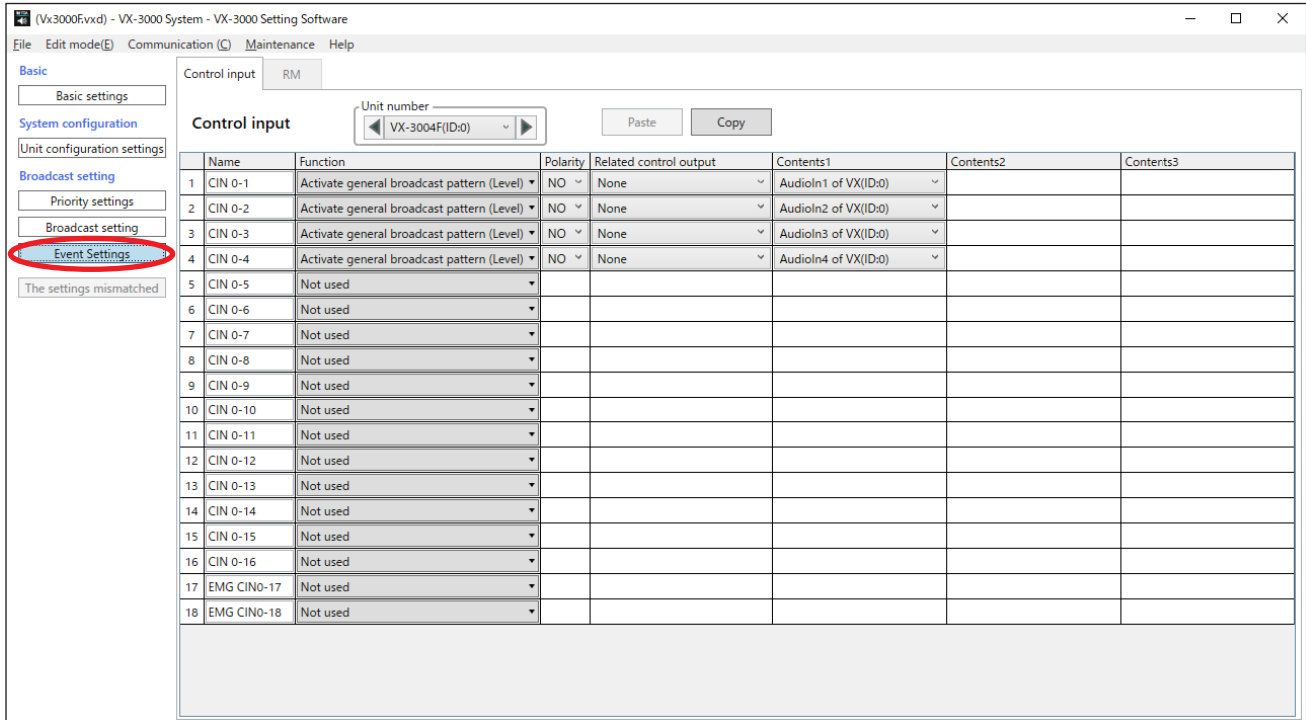

### 10.1. Control Input Setting

When the Control input tab is clicked on the Event setting screen, functions can be assigned to the control input terminals.

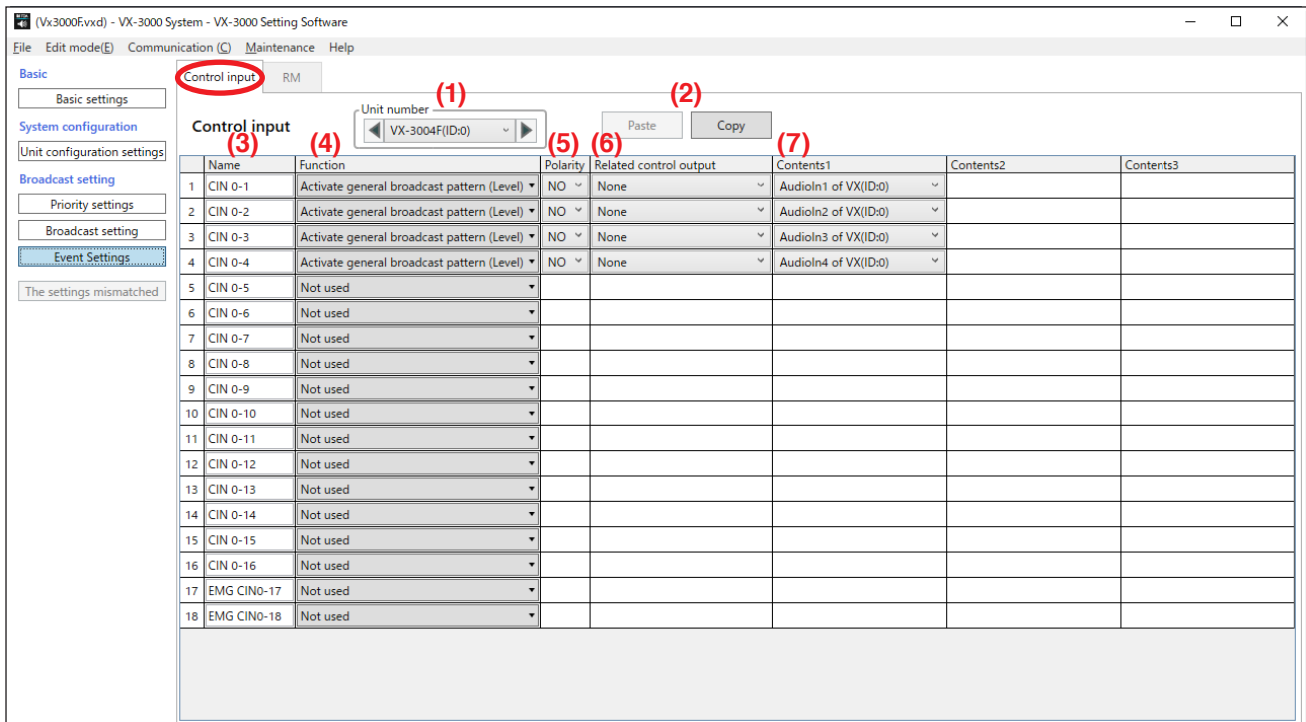

#### (1) Unit number

Click on the box, or click the arrow button to select the desired VX-3000F.

**(2) Copy and Paste buttons**

Clicking the Copy button copies all of the on-screen settings except "Name" (3) preset by default. Select another VX-3000F. Then, clicking the Paste button pastes the copied parameters in the setting screen of the selected "Unit number" (1).

**(3) Name**

Enter each name of the VX-3000F's control inputs.

Available Settings	Up to 32 alphanumeric characters (Default: for example, CIN 0-1 represents the control input 1 of the VX-3000F of ID No. 0.)
--------------------	--

**(4) Function**

Select functions for the control inputs.

If the selected function needs particular settings, they are displayed on the "Contents."

Available Settings	Not used (default), Activate general broadcast pattern (Level)* <sup>1</sup> , Activate general broadcast pattern (Pulse)* <sup>2</sup>
--------------------	---

\*<sup>1</sup> For the function of "Activate general broadcast pattern (Level)," see p. 3-113.

\*<sup>2</sup> For the function of "Activate general broadcast pattern (Pulse)," see p. 3-114.

**(5) Polarity**

Set the signal state that becomes active when "Function" is set to "Activate general broadcast pattern (Level)."

**Note**

When "Function" is set to "Activate general broadcast pattern (Pulse)," a make pulse of over 0.1 s becomes an active signal.

Available Settings	NO (default), NC
--------------------	------------------

**Tip**

To make "Closed" state a valid signal, select "NO."

To make "Open" state a valid signal, select "NC."

**(6) Related control output**

Select the control output pattern that operates in synchronization with the control input.

Set the control output pattern by selecting "Broadcast setting → Control output" (p. 2-34).

Available Settings	None (default), Set control output pattern
--------------------	--

**(7) Contents 1**

Select the sound source for general broadcast (General broadcast pattern) to be activated by the control input.

Set the general broadcast pattern by selecting "Broadcast setting → General broadcast" (p. 2-31).

Available Settings	Set general broadcast pattern
--------------------	-------------------------------

## 10.2. Remote Microphone Setting

When the RM tab is clicked on the Broadcast start setting screen, functions can be assigned to the remote microphone.

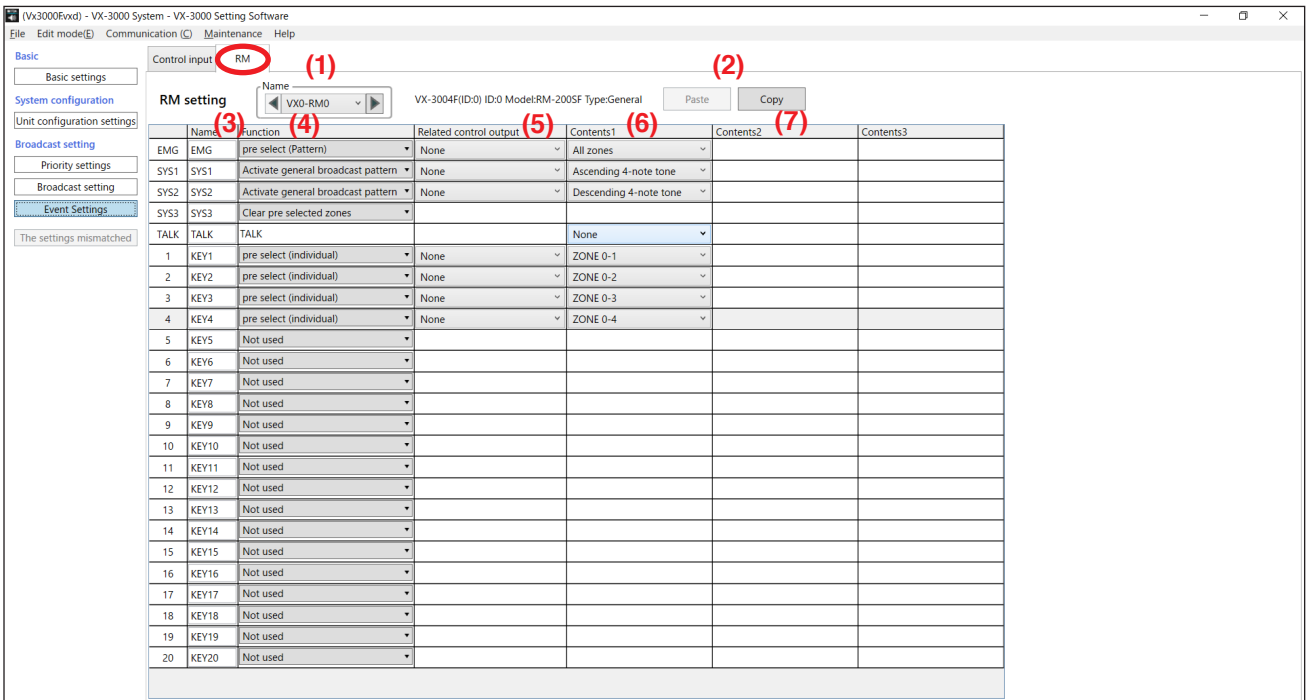

### (1) Name (Remote microphone)

Click on the box or click the arrow button to select the desired RM-200SF or RM-300X.

Function keys of the RM-320F or RM-210F are also displayed on the screen when the remote microphone to which the RM-320F or RM-210F is connected is selected.

### (2) Copy and Paste buttons

Clicking the Copy button copies all of the on-screen settings except the "Name" (3) preset by default.

Select another RM-200SF or RM-300X. Then, clicking the Paste button pastes the copied parameters in the setting screen of the selected "Name" (1).

### (3) Name (Key)

Enter the names of the keys of the RM-200SF, RM-300X, RM-320F, and RM-210F.

Available Settings	Up to 32 alphanumeric characters (Default: EMG for the Emergency key, SYS 1 – 3 and KEY 1 – up for the Function keys)
--------------------	---

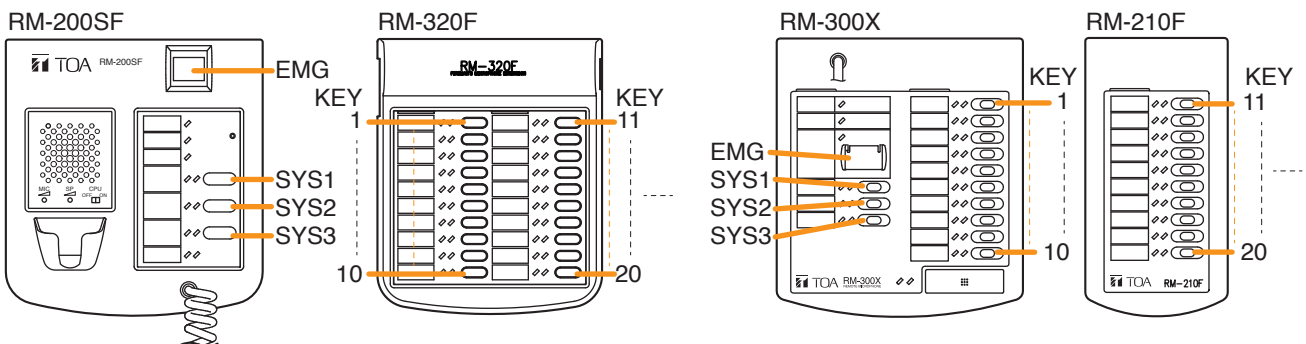

### (4) Function

Select functions to be assigned to the keys of the RM-200SF, RM-300X, RM-320F, and RM-210F.

If the selected function needs particular settings, they are displayed on the "Contents."

Available Settings	Not used (default), Activate general broadcast pattern*, Pre select (Pattern), Pre select (Individual), Clear pre selected zones
--------------------	--

\* For the "Activate base broadcast pattern" function, see p. 3-113.

**(5) Related control output**

Select the control output pattern to be synchronously activated when the remote microphone's function key or Talk key is pressed.

Set the control output pattern by selecting "Broadcast setting → Control output" (p. 2-34).

Available Settings	None (default), Set control output pattern
--------------------	--

**Note**

When "Function" is set to "TALK," it is not possible to set only the Interlock control output. Set the output zone and the output zone pattern, then the Interlock control output.

**[If "Activate general broadcast pattern" is selected for "Function"]****(6) Contents 1**

Select the general broadcast pattern to be activated by the function key of the remote microphone.

Set the general broadcast pattern by selecting "Broadcast setting → General broadcast" (p. 2-31).

Available Settings	Set general broadcast pattern
--------------------	-------------------------------

**[If "Pre select (Pattern)" is selected for "Function"]****(6) Contents 1**

The output zones to be assigned to the remote microphone's function key are displayed.

This setting is fixed to "All zones."

In the Simple mode, "All zones" is assigned to the combination of multiple output zones (Output zone pattern) in advance, and no other zone combinations can be used.

**[If "Pre select (Individual)" is selected for "Function"]****(6) Contents 1**

Select the output zone (individual) to be assigned to the remote microphone's function key.

Available Settings	None (default), Set output zone (individual)
--------------------	--

**[If "TALK" is selected for "Function"]****(6) Contents 1**

Select the zones to which broadcasts are made when the remote microphone's Talk key is pressed if no broadcast zones are selected with its Function key to which "Pre select" function has been assigned.

When "Individual zone" is selected, the broadcast zone can be selected from the individual zones in "Contents 2."

When "Pattern" is selected, the broadcast zones can be selected from the output zone patterns in "Contents 2."

When "None" is selected, broadcast cannot be made through the Talk key operation alone.

Regardless of any setting made here, when the talk key is pressed after the broadcast zone or zones are selected by the function key to which "Pre select" function is assigned, broadcast is made to the selected zone or zones.

Available Settings	None (default), Individual zone, Pattern
--------------------	--

**(7) Contents 2****[When "Contents 1" is set to "Individual zone"]**

Select the VX-3000F's output zone (individual).

Available Settings	Set output zone (individual)
--------------------	------------------------------

**[When "Contents 1" is set to "Pattern"]**

The output zones to be assigned to the remote microphone's talk key are displayed.

This setting is fixed to "All zones."

In the Simple mode, "All zones" is assigned to the combination of multiple output zones (Output zone pattern) in advance, and no other zone combinations can be used.

## 11. CONFIRMING DISCREPANCIES IN SET DATA

The [The settings mismatched] button flashes red ( **The settings mismatched** ) if there is any error in the setting content. Clicking the [The settings mismatched] button displays the following screen and you can confirm the error point.

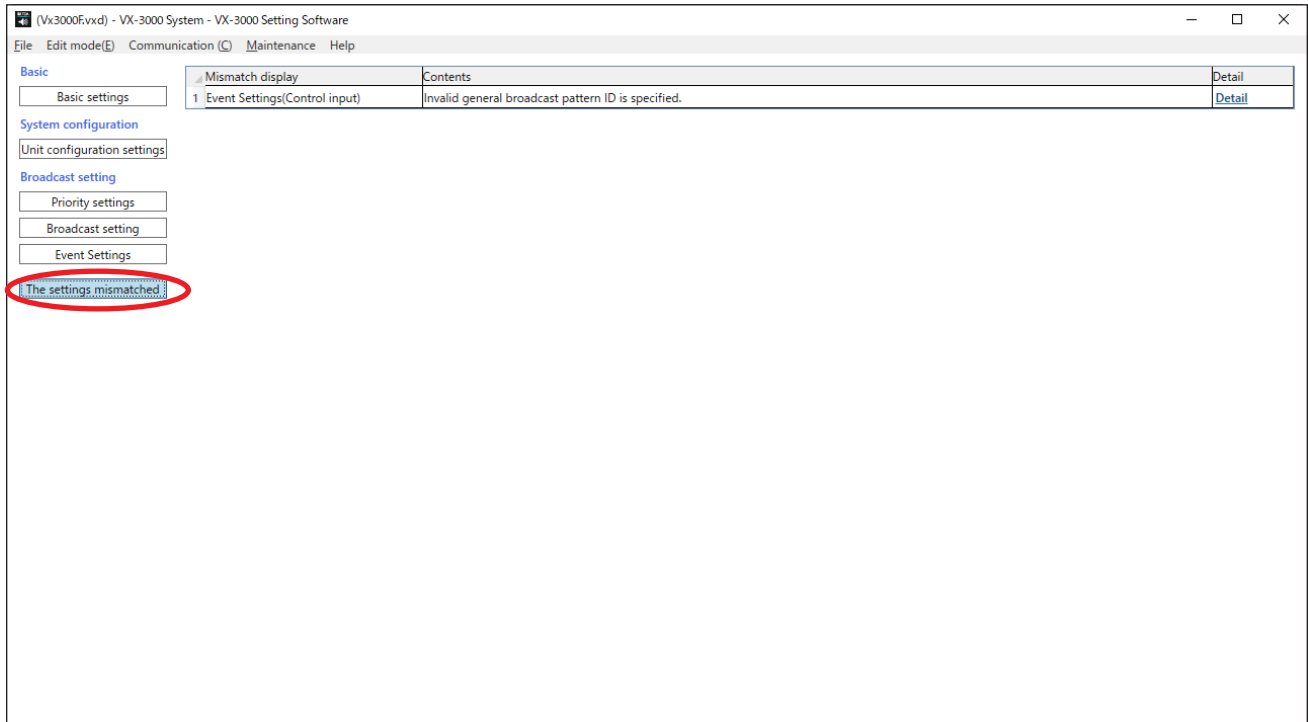

### (1) Mismatch display

Displays the setting screen with the setting error.

### (2) Contents

Displays the setting error contents.

### (3) Detail

If clicked, a dialog shown below will be displayed.

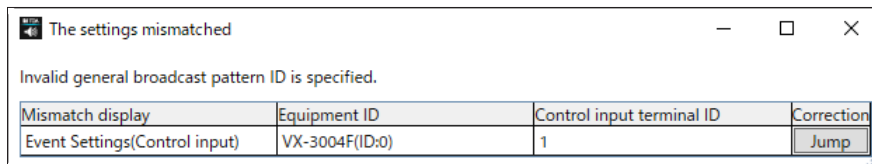

### • Jump

Clicking the [Jump] button located at right on each line switches the display to the setting screen with the setting error. Check the set content and correct the error.

## 12. APPENDIX: ITEMS TO BE AUTOMATICALLY REGISTERED

In the Simple mode, the items listed below are automatically registered.

Setting menu	Setting item		Setting when in the Simple mode
Basic settings	General broadcast in case of AC fault		Stop
Unit configuration settings	Settings for audio input	Type	AUDIO IN 4: BGM
		Mixing setting	AUDIO IN 4:REDUCTION (Fade out/Fade in/Attenuation are the same as those in the Normal mode.)
	RM configuration setting	Type of AUX	BGM
		Type of Mixing setting	REDUCTION (Fade out/Fade in/Attenuation are the same as those in the Normal mode.)
Amplifier configuration settings	Broadcast zone (from each amplifier) setting	1st amplifier unit	ZONE 1 – 4
		2nd amplifier unit	ZONE 5 – 8
Internal EV settings	Registration		The following sounds are automatically registered. No. 1: Ascending 4-note tone No. 2: Descending 4-note tone No. 3: 2-tone chime No. 4: Gong
	Chime setting		
Pattern settings	Output zone pattern setting		Addition of all zones (x 1)
	General broadcast pattern setting* <sup>1</sup>		Addition of the setting to broadcast from each audio input to all zones (x 4) When adding the RM-300X, addition of the setting to broadcast from its AUX to all zones Addition of the setting to broadcast from each chime sound source to all zones (x 4)
	Control output pattern setting* <sup>1</sup>		Addition of each VX-3000F's each control output as a pattern (the number of the VX-3000F units multiplied by the number of the VX-3000F's control outputs)
Event settings	Control input event setting* <sup>2</sup>		Addition of the "Activate general broadcast pattern (Level)" of each frame's each audio input to each frame's control inputs 1 through 4 (x 4)
	RM event setting* <sup>2</sup>		EMG: Pre select (Pattern) All zones SYS1: General pattern broadcast (Ascending 4-note tone) SYS2: General pattern broadcast (Descending 4-note tone) SYS3: Clear pre selected zone KEY1: Pre select (Individual) Own unit's individual output line (Zone 1) KEY2: Pre select (Individual) Own unit's individual output line (Zone 2) Similarly, assignment to the keys continues by the number of effective zones.

In the Simple mode, it is possible to change the setting marked with asterisk 1 in the broadcast setting and that marked with asterisk 2 in the Event settings. Other settings cannot be changed.

# ***Chapter 3***

---

***USING IN THE NORMAL MODE***

# 1. SETTING TO THE NORMAL MODE

The VX-3000 Setting software is placed in the Simple mode at the first start-up after it has been installed. Change the setting mode to the Normal mode with the procedures below.

**Step 1.** Select [Setting mode] → [Normal mode] from the menu bar.

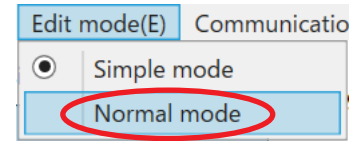

A dialog at right appears.

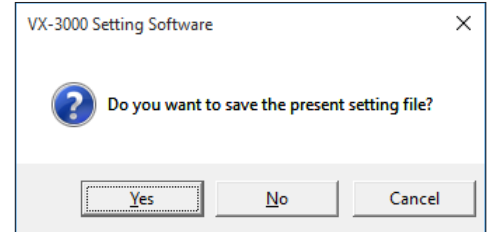

**Step 2.** Click the "Yes" or "No" button as needed.

When the Yes button has been clicked, select the designation folder and save the current setting.

The setting mode is switched to the Normal mode after the current setting is saved or cancelled.

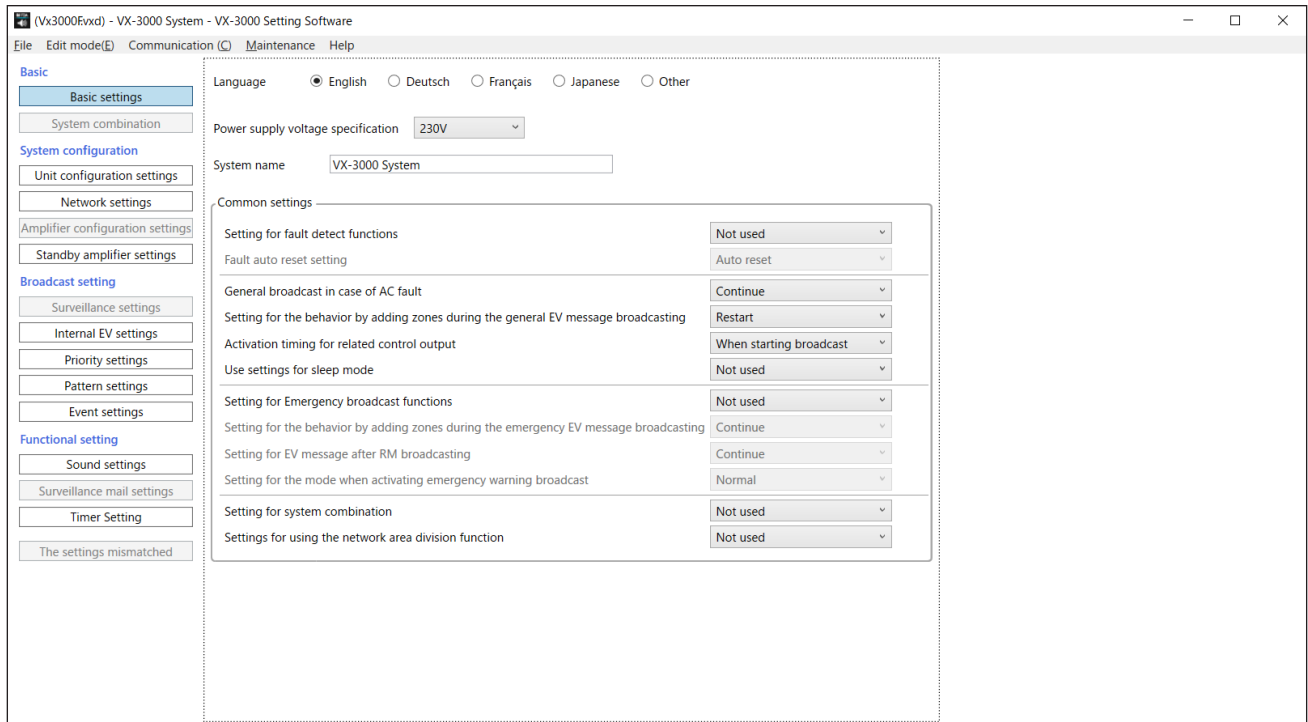

When the software is terminated in the Normal mode, it will be placed in the Normal mode when activated next time.

## 2. SETTING PROCEDURE

### 2.1. When Creating a Setting Project File in Advance

Shown below is a general procedure for creating a Setting project file in advance and uploading it on completion of the unit detection at the installation site.

#### 1. Create a new setting project file.

- (1) Select [File] → [New] from the menu bar, then start setting.
- (2) Perform settings from "Basic settings" to "Event setting" in order from the top of the menu item to the bottom.
  - Basic settings: Perform settings related to the entire system such as displayed language setting of the Setting software, system name, and use of the failure detection function, etc.
  - Unit configuration settings: Set the Unit configuration of the VX-3000F, Remote microphones, VX-3000PM, and VX-3000CT.
  - Network settings: Perform the network settings for the VX-3000F, VX-3000PM, and VX-3000CT.
  - Amplifier configuration setting: Perform the configuration of 2 amplifier modules to be installed to the VX-3008F and output zones.
  - Standby amplifier settings: Perform each VX-3000F's Standby amplifier sharing setting.
  - Surveillance settings: Set the surveillance target points.
  - Internal EV setting: Register the sound source files to be stored in the VX-3000F and set the EV's sound sources and chime sound sources.
  - Priority settings: Set priority levels of the following audio sources: the VX-3000F's built-in sound sources, chime sound sources, and audio inputs, the VX-3000PM's audio inputs, and the remote microphones.
  - Pattern settings: Set Zone, Base pattern, General broadcast, Control output, Emergency sequence, Emergency broadcast, and Failure.
  - Event settings: Perform function assignment to the VX-3000F's control inputs, the VX-3000CT's volume controls and function keys, and the remote microphone's each key, and assign the failure detection pattern to the Fault indicator.
  - Sound settings: Adjust the sound and volume of the VX-3000F's input/output and the VX-3000PM's audio input.  
When using the ANC function, also perform settings for the output side of the ANC function (p. 3-24).
  - Surveillance mail settings: Perform the settings concerning the function to send an e-mail notification when a failure has occurred or has been reset.
  - Timer Setting: To create weekly and holiday programs, register the daily event schedule as a daily program, then assign the daily program to each day of the week and the set holiday period.
- (3) When the [The settings mismatched] button is flashing red, check the set contents and correct the error setting.

#### 2. Save the setting project file.

Select [File] → [Save As] from the menu bar to save the setting project file.

[To the next page](#)

From the next page



**3. Connect to the VX-3000F online, then transmit the settings from the Setting software.**

Select [Communication] → [Setting data & Audio source upload (PC->VX)] from the menu bar to transmit the Setting project file to the VX-3000F.

**Tip**

A password input dialog appears when a password has been set to the VX-3000F (No password is set by default.).

If a password is entered, the setting data and the audio data will be written.

For password setting, see [p. 3-176](#).

## 2.2. When Creating the Setting Project File at the Installation Site

Shown below is a general procedure for creating a Setting project file after having acquired the unit configuration by executing the unit detection at the installation site.

### 1. Connect to the VX-3000F online to acquire the unit configuration data.

- (1) Display the Unit configuration settings screen.
- (2) Click the [Receiving the unit configuration] button to display the "Receiving the unit configuration" window.
- (3) Check the target checkbox for the unit to receive the unit configuration data from the displayed unit list, then click the OK button.
- (4) Close the "Receiving the unit configuration" window after the unit configuration data reception is complete.

### 2. Create the setting project file.

- (1) Perform settings from "Basic settings" to "Event setting" in order from the top of the menu item to the bottom.
  - Basic settings: Perform settings related to the entire system such as displayed language setting of the Setting software, system name, and use of the failure detection function.
  - Unit configuration settings: Set the Unit configuration of the VX-3000F, Remote microphones, VX-3000PM, and VX-3000CT.
  - Network settings: Perform the network settings for the VX-3000F, VX-3000PM, and VX-3000CT.
  - Amplifier configuration setting: Perform the configuration of 2 amplifier modules to be installed to the VX-3008F and output zones.
  - Standby amplifier settings: Perform each VX-3000F's Standby amplifier sharing setting.
  - Surveillance settings: Set the surveillance target points.
  - Internal EV setting: Register the sound source files to be stored in the VX-3000F and set the EV's sound sources and chime sound sources.
  - Priority settings: Set priority levels of the following audio sources: the VX-3000F's built-in sound sources, chime sound sources, and audio inputs, the VX-3000PM's audio inputs, and the remote microphones.
  - Pattern settings: Set Zone, Base pattern, General broadcast, Control output, Emergency sequence, Emergency broadcast, and Failure.
  - Event settings: Perform function assignment to the VX-3000F's control inputs, the VX-3000CT's volume controls and function keys, and the remote microphone's each key, and assign the failure detection pattern to the Fault indicator.
  - Sound settings: Adjust the sound and volume of the VX-3000F's input/output and the VX-3000PM's audio input.  
When using the ANC function, also perform settings for the output side of the ANC function (p. 3-24).
  - Surveillance mail settings: Perform the settings concerning the function to send an e-mail notification when a failure has occurred or has been reset.
  - Timer Setting: To create weekly and holiday programs, register the daily event schedule as a daily program, then assign the daily program to each day of the week and the set holiday period.
- (2) When the [The settings mismatched] button is flashing red, check the set contents and correct the error setting.

To the next page

From the previous page

### 3. Save the setting project file.

Select [File] → [Save As] from the menu bar to save the setting project file.

### 4. Transmit the settings from the Setting software to the VX-3000F.

Select [Communication] → [Setting data & Audio source upload (PC->VX)] from the menu bar to transmit the Setting project file to the VX-3000F.

**Tip**

A password input dialog appears when a password has been set to the VX-3000F (No password is set by default.).

If a password is entered, the setting data and the audio data will be written.

For password setting, see [p. 3-176](#).

## 2.3. When Changing the Setting by After Acquiring It from the Unit

Shown below is a general procedure for modifying a Setting project file after having acquired the unit configuration by executing the unit detection at the installation site.

### 1. Connect to the VX-3000F online to acquire the unit configuration data.

(1) Display the Unit configuration settings screen.

(2) Click the [Receiving the unit configuration] button to display the "Receiving the unit configuration" window.

(3) Check the target checkbox for the unit to receive the unit configuration data from the displayed unit list, then click the OK button.

(4) Close the "Receiving the unit configuration" window after the unit configuration data reception is complete.

### 2. Acquire the Setting project file from the VX-3000F.

Select [Communication] → [Setting data & Audio source download (VX->PC)] from the menu bar to acquire the Setting project file from the VX-3000F.

### 3. Change the Setting project file.

(1) Change the setting as needed.

(2) When the [The settings mismatched] button is flashing red, check the set contents and correct the error setting.

### 4. Save the setting project file.

Select [File] → [Save As] from the menu bar to save the setting project file.

### 5. Transmit the settings from the Setting software to the VX-3000F.

Select [Communication] → [Setting data & Audio source upload (PC->VX)] from the menu bar to transmit the Setting project file to the VX-3000F.

**Tip**

A password input dialog appears when a password has been set to the VX-3000F (No password is set by default.).

If a password is entered, the setting data and the audio data will be written.

For password setting, see [p. 3-176](#).

## 3. EXPLANATIONS OF TERMS AND FUNCTIONS

### 3.1. Pattern

A "pattern" is a grouped unit made by combining setting statuses of several setting items. For example, various broadcast patterns are made by combining the selected input sound sources and broadcast zones into groups, and control output patterns are made by grouping the selected control outputs. Set various patterns can be used as the setting contents when creating other types of patterns or when allocating the functions in the Event settings.

### 3.2. Event

An "event" refers to the set operation to be performed by feeding signals to the control input terminals or pressing the function key. Allocatable functions differ depending on the terminals or keys to be used.

### 3.3. Internal EV

Sound source files can be registered into the VX-3000F. Up to 1024 Sound source files can be registered per system. To use the sound source files for broadcasts, set them as EV message.

### 3.4. General-Purpose Broadcasts

General-purpose broadcasts include announcements made by Remote Microphones, time-controlled chimes, and spot commercials. To make general-purpose broadcasts, set general-purpose broadcast patterns (comprised of various combinations of input channels, priority levels, broadcast zones, etc.), then activate these patterns by the following means.

- Control inputs of the VX-3000F and VX-3000PM
- Keys on the VX-3000CT, RM-200SF, RM-320F, RM-300X, or RM-210F

The broadcasts activated by control inputs are made only while the control signal is ON after audio and control signals from input devices (such as microphones and audio file players) enter the VX-3000 system.

#### 3.4.1. Settings necessary to make general-purpose pattern broadcasts

To make general-purpose pattern broadcasts, follow the procedures below to perform each setting using the VX-3000 Setting software.

#### 1. Register the internal EV. (Only when using the EV message)

When using the EV message, register the sound source files on the Internal EV setting screen, then set the EV message.

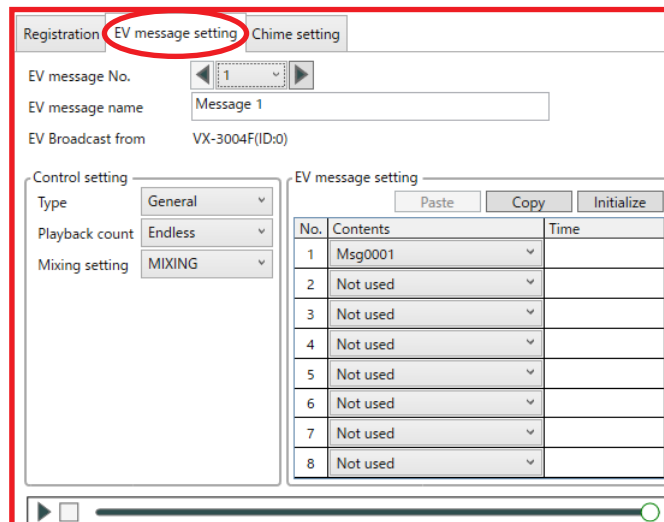
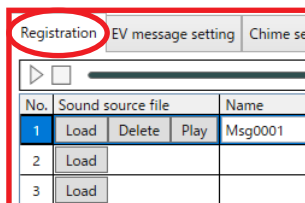

To the next page

From the previous page

**2. Set the priority level.**

Set the broadcast priority level for each sound source on the Priority settings screen.

**3. Set the output zone pattern. (Only when using the output zone pattern)**

Perform this in the "Zone pattern setting."

Zone	Base pattern	General broadcast	Control output	Emergency sequence	Emergency broadcast	Em
No.	◀ 1 ▶					Paste Copy
Name	Zone pattern 1					
ALL						
VX-3004F(ID:0)	ZONE 0-1	ZONE 0-2	ZONE 0-3	ZONE 0-4		
VX-3008F(ID:1)	ZONE 1-1	ZONE 1-2	ZONE 1-3	ZONE 1-4		
VX-3016F(ID:2)	ZONE 2-1	ZONE 2-2	ZONE 2-3	ZONE 2-4		
	ZONE 2-9	ZONE 2-10	ZONE 2-11	ZONE 2-12		

**4. Set the general-purpose broadcast patterns.**

Perform this in the "General broadcast pattern setting."

Zone	Base pattern	General broadcast	Control output	Emergency sequence	Emergency broadcast	Eme
No.	◀ 1 ▶					Paste Copy
Name	General pattern 1					
Audio Source	<input checked="" type="radio"/> EV message <input type="radio"/> Audio Input <input type="radio"/> AUX					
	Message 1 <span style="background-color: #00AEEF; color: white; padding: 2px;">General</span>					
Start chime	None					
End chime	None					
Start chime wait time	0.0[sec]					
Output	<input checked="" type="radio"/> Individual zone <input type="radio"/> Pattern					
	ZONE 0-1					

**5. Set the control output patterns. (Only when using the control output patterns)**Set the control output to be interlocked with the control input or key operation.  
Perform this in the "Control output pattern setting."

Zone	Base pattern	General broadcast	Control output	Emergency sequence	Emergency broadcast	Emergency broadcast
No.	◀ 1 ▶					Paste Copy
Name	Control output pattern 1					
ALL						
VX-3004F(ID:0)	ATT/COU 0-1	ATT/COU 0-2	ATT/COU 0-3	ATT/COU 0-4	ATT/COU 0-5	
	COU 0-9	COU 0-10	COU 0-11	COU 0-12	COU 0-13	
VX-3008F(ID:1)	ATT/COU 1-1	ATT/COU 1-2	ATT/COU 1-3	ATT/COU 1-4	ATT/COU 1-5	
	COU 1-9	COU 1-10	COU 1-11	COU 1-12	COU 1-13	
VX-3016F(ID:2)	ATT/COU 2-1	ATT/COU 2-2	ATT/COU 2-3	ATT/COU 2-4	ATT/COU 2-5	
	ATT/COU 2-9	ATT/COU 2-10	ATT/COU 2-11	ATT/COU 2-12	ATT/COU 2-13	
	COU 2-17	COU 2-18	COU 2-19	COU 2-20	COU 2-21	

To the next page

From the previous page

**6. Assign a function to the control input of the VX-3000F and VX-3000PM or to the key on the remote microphone and the VX-3000CT.**

Assign "Activate general broadcast pattern (Level)" or "Activate general broadcast pattern (Pulse)" to the control input.

Assign "Activate general/BGM broadcast" or "Activate general broadcast pattern" to the key on the remote microphone.

Perform this in the "Event settings."

Control input RM VX-3000CT setting Fault LED setting Audio network output setting

Control input Unit number  
VX-3004F(ID:0) Paste Copy

	Name	Function	Polarity	Related control output	Contents1
1	CIN 0-1	Activate general broadcast pattern (Level)	NO	None	General pattern 1
2	CIN 0-2	Activate general broadcast pattern (Pulse)		None	General pattern 1

Control input RM VX-3000CT setting Fault LED setting Audio network output setting

RM event settings Name  
VX0-RM0 VX-3004F(ID:0) ID:0 Model:RM-200SF Type:General Paste

	Name	Function	Related control output	Contents1	Contents2
EMG	EMG				
SYS1	SYS1	Activate general/BGM broadcast		EV message	Message 1
SYS2	SYS2	Not used			
SYS3	SYS3	Not used			
TALK	TALK	TALK		None	
1	KEY1	Not used			
2	KEY2	Not used			
3	KEY3	Not used			

Control input RM VX-3000CT setting Fault LED setting Audio network output setting

CT event settings Name  
VX-3000CT(VX0-0) VX-3004F(ID:0) VX0-0 Model:VX-3000CT Paste

	Name	Function	Related control output	Contents1
Vol1	Vol 1	Not used		
Vol2	Vol 2	Not used		
Vol3	Vol 3	Not used		
Vol4	Vol 4	Not used		
Vol5	Vol 5	Not used		
Vol6	Vol 6	Not used		
Vol7	Vol 7	Not used		
Vol8	Vol 8	Not used		
Key1	Key 1	Activate general broadcast pattern	None	General pattern 1
Key2	Key 2	Not used		
Key3	Key 3	Not used		

### 3.4.2. General-purpose broadcast pattern setting example

In the example below, the table shows a pattern comprised of several general-purpose broadcast sound sources and broadcast zones.

An output zone pattern is the one into which multiple broadcast zones are grouped, so broadcast can be made to multiple zones simultaneously by activating only one pattern.

#### [Output zone pattern setting]

		Zones VX-3004F's speaker outputs			
		1	2	3	4
Output zone pattern (No.)	1	✓	✓	✓	✓
	2	✓			
	3		✓		
	4			✓	

The input channels of the VX-3004F are designated as sound sources for general-purpose broadcasts or BGM, while the output channels (individual) or output zone patterns of the VX-3004F are designated as zones.

#### [General-purpose broadcast pattern setting]

		Output zone pattern (No.)			
		1	2	3	4
Input Sources VX-3004F's Audio Input Channels (CH)	1	✓			
	2		✓		
	3			✓	
	4				✓

Broadcasts are made as follows when the above general-purpose broadcast pattern is used.

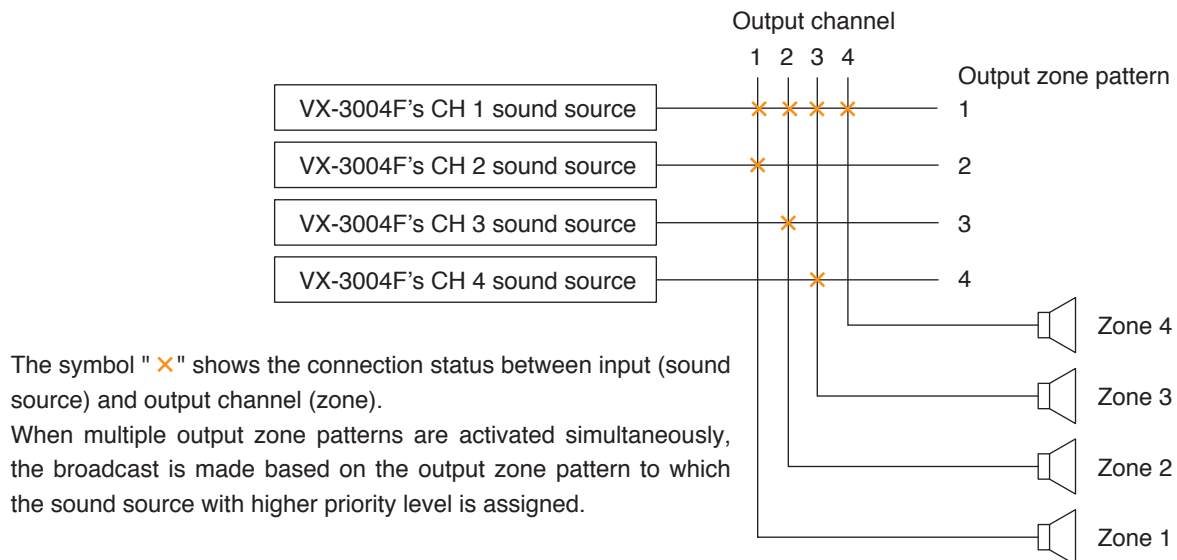

#### Notes

- The VX-3000F has the following 10 input sound sources which are built-in or externally applied.  
Audio inputs 1 through 4, EV playback\*<sup>1</sup> x 4, RS Link A\*<sup>2</sup>, and RS LINK B\*<sup>2</sup>  
Up to 8 of the 10 input sound sources can be simultaneously output to other VX-3000F units according to the priority level assigned to each sound source.
- \*<sup>1</sup> 1024 EV sound sources can be registered in each VX-3000F and up to 4 of them can be played back simultaneously according to the priority level.
- \*<sup>2</sup> Up to 4 remote microphones can be connected to the RS Link A but only one of them is allowed to make announcements according to the priority level. Similarly, one of 4 remote microphones connected to the RS Link B is allowed to make announcements.
- The VX-3000PM has 8 input sound sources from the audio inputs 1 through 8. These input sound sources are output to other VX-3000F units according to the priority levels set to them. However, up to 7 unicast stream outputs can be distributed to the different network in the case of broadcast among networks.

### 3.5. Base Pattern Broadcast

These broadcasts are generated by inputting audio signals originating only from BGM player devices into the VX-3000 system, and are usually sent at relatively low volumes. Base pattern broadcast is conducted by first setting Base patterns (comprised of various combinations of input channels, broadcast zones, etc.), then activating these patterns. It is possible to perform settings so that multiple BGM sources are output to multiple zones using a single Base pattern. Base patterns can be activated using the keys on the VX-3000CT, RM-200SF, RM-300X, RM-320F, or RM-210F, or the control input on the VX-3000F or VX-3000PM.

To make Base pattern broadcast, perform each setting using the VX-3000 Setting software. The setting procedures are the same as those of general-purpose pattern broadcast. However, there is no need to perform output zone patterns.

#### [Base pattern setting example]

In the example below, the table shows a pattern comprised of several BGM sound sources and broadcast zones. The input channels of the VX-3004F are designated as BGM input sources, while the output channels of the VX-3004F are designated as the zones.

		Zones VX-3004F's speaker outputs			
		1	2	3	4
Input Sources VX-3004F's Audio Input Channels (CH)	1	✓			
	2		✓		✓
	3			✓	
	4				

Broadcasts are made as follows when the above Base pattern broadcast pattern is used.

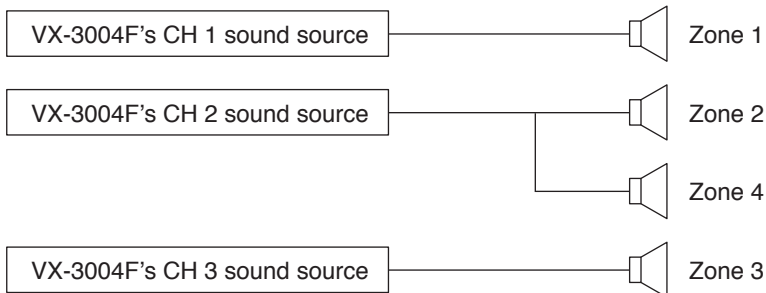

## 3.6. Emergency Warning Broadcast

### 3.6.1. What is Emergency warning broadcast

Emergency Warning Broadcast is the broadcast of which audio source type is set to "Emergency warning" and is activated through the key operation on the remote microphone and the VX-3000CT or by way of the control input.

The audio source type of only the VX-3000F's or the VX-3000PM's Audio inputs can be set to "Emergency warning."

Emergency warning broadcast is different from the Emergency broadcast and can be used regardless of ON/OFF setting of the emergency broadcast function. The broadcast mode does not change before and after activation.

It can be used even during power failure regardless of ON/OFF setting of the general broadcast during power failure.

When attenuators are used in the broadcast zones, the emergency warning broadcast is made bypassing the attenuators and signal processing.

Priority level can be set in the range of 1 to 1024.

When the emergency warning broadcast is activated while the higher-priority broadcast is in progress, the emergency warning broadcast is placed in standby, and will start after the higher-priority broadcast is complete.

### 3.6.2. Operation of the Emergency warning broadcast when using the Emergency broadcast function

When using the emergency broadcast function, it is possible to set whether or not to activate the emergency mode in the emergency warning broadcast.

#### [Operation when handling the emergency warning broadcast as general broadcast]

If "Setting for the mode when activating emergency warning broadcast" (p. 3-40) is set to "Normal" in the "Basic settings," the operation is as follows.

The broadcast mode does not change before and after the emergency warning broadcast activation.

When the priority set to the emergency warning broadcast is higher than the emergency broadcast, the emergency warning broadcast will override the emergency broadcast in progress. In this event, the emergency mode will not be cancelled and remains unchanged. During general broadcast, the emergency warning broadcast will override the general broadcast while left in the normal mode.

#### [Operation when activating the emergency mode in the emergency warning broadcast]

If "Setting for the mode when activating emergency warning broadcast" (p. 3-40) is set to "Emergency mode" in the "Basic settings," the operation is as follows.

When the emergency warning broadcast is activated, it will be placed in the emergency mode.

At the time of emergency warning activation, even when the emergency warning broadcast is placed in standby while the higher-priority broadcast is in progress, the mode will be changed to the emergency mode.

The emergency mode also terminates when the emergency warning broadcast terminates.

Unlike the emergency broadcast, the emergency reset operation is not needed.

When the priority level set to the emergency warning broadcast is higher than the emergency broadcast, the emergency warning broadcast will override the emergency broadcast in progress. However, if the emergency broadcast is activated, the mode will not return to the normal mode until emergency reset operation is performed even when the emergency warning broadcast is terminated.

### 3.6.3. Setting for emergency warning broadcast

To use the emergency warning broadcast function, follow the procedures below to perform each setting using the VX-3000 Setting software.

#### 1. Set the audio source type of the VX-3000F's Audio input to "Emergency warning."

Perform this setting in the VX-3000F's "Unit configuration settings."

VX-3004F(ID:0)						
VX configuration setting		Settings for audio input		Settings for audio output		Settings for terminals
	Name	Purpose	Phantom power	Input Mix	Type	Mixing setting
AUDIO IN1	Analog 0-1	LINE		AUDIO IN1	Emergency warning	BGM CUT
AUDIO IN2	Analog 0-2	LINE		AUDIO IN2	General	MIXING
AUDIO IN3	Analog 0-3	LINE		AUDIO IN3	General	MIXING
AUDIO IN4	Analog 0-4	LINE		AUDIO IN4	General	MIXING

#### 2. Set the priority level.

Set the broadcast priority level for each sound source on the Priority settings screen.

#### 3. Set the output zone pattern. (Only when using the output zone pattern)

Perform this in the "Zone pattern setting."

Zone	Base pattern	General broadcast	Control output	Emergency sequence	Emergency broadcast	Emergency broadcast
No.	1					
Name	Zone pattern 1					
ALL						
VX-3004F(ID:0)	ZONE 0-1	ZONE 0-2	ZONE 0-3	ZONE 0-4		
VX-3008F(ID:1)	ZONE 1-1	ZONE 1-2	ZONE 1-3	ZONE 1-4		
VX-3016F(ID:2)	ZONE 2-1	ZONE 2-2	ZONE 2-3	ZONE 2-4		
	ZONE 2-9	ZONE 2-10	ZONE 2-11	ZONE 2-12		

#### 4. Set the control output patterns. (Only when using the control output patterns)

Set the control output to be interlocked with the control input or key operation.  
Perform this in the "Control output pattern setting."

Zone	Base pattern	General broadcast	Control output	Emergency sequence	Emergency broadcast	Emergency broadcast
No.	1					
Name	Control output pattern 1					
ALL						
VX-3004F(ID:0)	ATT/COU 0-1	ATT/COU 0-2	ATT/COU 0-3	ATT/COU 0-4	ATT/COU 0-5	
	COU 0-9	COU 0-10	COU 0-11	COU 0-12	COU 0-13	
VX-3008F(ID:1)	ATT/COU 1-1	ATT/COU 1-2	ATT/COU 1-3	ATT/COU 1-4	ATT/COU 1-5	
	COU 1-9	COU 1-10	COU 1-11	COU 1-12	COU 1-13	
VX-3016F(ID:2)	ATT/COU 2-1	ATT/COU 2-2	ATT/COU 2-3	ATT/COU 2-4	ATT/COU 2-5	
	ATT/COU 2-9	ATT/COU 2-10	ATT/COU 2-11	ATT/COU 2-12	ATT/COU 2-13	
	COU 2-17	COU 2-18	COU 2-19	COU 2-20	COU 2-21	

To the next page

From the previous page

**5. Assign the function to the control input of the VX-3000F and VX-3000PM or to the key on the remote microphone and VX-3000CT.**

Assign "Emergency warning broadcast" to the control input or the key on the remote microphone. Perform this in the "Event settings."

Control input RM VX-3000CT setting Fault LED setting Audio network output setting

Control input Unit number  
 ◀ VX-3004F(ID:0) ▶ Paste Copy

	Name	Function	Polarity	Related control output	Contents1	Contents2	Contents3
1	CIN 0-1	Emergency warning broadcast	NO	None	Analog 0-1	Individual zone	ZONE 0-1
2	CIN 0-2	Not used					

Control input RM VX-3000CT setting Fault LED setting Audio network output setting

RM event settings Name  
 ◀ VX0-RM0 ▶ VX-3004F(ID:0) ID:0 Model:RM-200SF Type:General Paste Copy

	Name	Function	Related control output	Contents1	Contents2	Contents3
EMG	EMG					
SYS1	SYS1	Emergency warning broadcast	None	Analog 0-1	Pattern	Zone pattern 1
SYS2	SYS2	Not used				

Control input RM VX-3000CT setting Fault LED setting Audio network output setting

CT event settings Name  
 ◀ VX-3000CT(VX0-0) ▶ VX-3004F(ID:0) VX0-0 Model:VX-3000CT Paste Copy

	Name	Function	Related control output	Contents1	Contents2	Contents3
Vol1	Vol 1	Not used				
Vol2	Vol 2	Not used				
Vol3	Vol 3	Not used				
Vol4	Vol 4	Not used				
Vol5	Vol 5	Not used				
Vol6	Vol 6	Not used				
Vol7	Vol 7	Not used				
Vol8	Vol 8	Not used				
Key1	Key 1	Emergency warning broadcast	None	Analog 0-1	Individual zone	ZONE 0-1

### 3.7. Emergency Broadcast

Emergency broadcast is conducted by first setting the combinations of the Emergency Sequences, Output zones (individual or pattern), and Control Output patterns as Emergency Broadcast Patterns, then activating these patterns by pressing the key on the remote microphone or via the control input of the VX-3000F.

When attenuators are used in the broadcast zones, the emergency broadcast is made bypassing the attenuators and signal processing.

A maximum of 1024 patterns can be set for the Emergency Broadcast Patterns.

A combination of the EV message (sound source) and its broadcast duration is set as a single phase for the Emergency Sequences, each of which can contain up to 3 levels (up to 30 levels when the Extension mode is in use) of phases. A maximum of 32 Emergency Sequences can be set.

Emergency Sequence	Phase 1	Phase 2	Phase 3
	EV message + broadcast duration	EV message + broadcast duration	EV message + broadcast duration

#### Note

An EV message is a short form of Electronic Voice Message. These messages are recorded as audio files.

The separately created EV messages are registered using the Setting software, and each message is set to one of 3 types: Alert, Evacuation, and Restoration depending on the contents.

The Alert and Evacuation messages are used in emergency situation, while the Restoration message is used to notify that the emergency situation is over.

1024 kinds of EV messages can be recorded on the VX-3000F's internal memory device.

Output zone pattern is the one into which multiple broadcast zones are grouped, so broadcast can be made to multiple zones simultaneously by activating only one pattern.

Similarly, control output pattern is the one into which multiple control outputs are grouped. This control output pattern can be used, for example, to activate multiple control outputs in synchronization with the emergency broadcast.

Output zone pattern	Multiple zones
---------------------	----------------

Control output pattern	Multiple control outputs
------------------------	--------------------------

#### Note

The emergency broadcast cannot be activated by the function key of the remote microphone of which TALK setting type (p. 3-63) is set to "General," by the VX-3000CT's function key, and by way of the VX-3000PM's control input.

To use the emergency broadcast function, follow the procedures below to perform each setting using the VX-3000 Setting software.

### 1. Set the emergency broadcast function to "Used."

Perform this in the "Basic settings."

Setting for Emergency broadcast functions: **Used**

Setting for the behavior by adding zones during the emergency EV message broadcasting: Continue

Setting for EV message after RM broadcasting: Continue

Setting for the mode when activating emergency warning broadcast: Normal

### 2. Register the EV messages.

Perform this in the "Internal EV setting (Registration tab and EV message setting tab)."

**Registration Tab:**

No.	Sound source file	Delete	Play	Name
1	Load			Alert
2	Load			
3	Load			

**EV message setting Tab:**

EV message No.: 1

EV message name: Message 1

EV Broadcast from:

Control setting:

Type: Alert

Playback count: Endless

EV message setting table:

No.	Contents	Time
1	Alert	
2	Not used	
3	Not used	
4	Not used	
5	Not used	
6	Not used	
7	Not used	
8	Not used	

### 3. Set the output zones to make emergency broadcast.

Perform this in the "Zone pattern setting."

Zone

No.: 1

Name: Zone pattern 1

ALL

VX-3004F(ID:0)	ZONE 0-1	ZONE 0-2	ZONE 0-3	ZONE 0-4
VX-3008F(ID:1)	ZONE 1-1	ZONE 1-2	ZONE 1-3	ZONE 1-4
VX-3016F(ID:2)	ZONE 2-1	ZONE 2-2	ZONE 2-3	ZONE 2-4
	ZONE 2-9	ZONE 2-10	ZONE 2-11	ZONE 2-12

To the next page

From the previous page

#### 4. Set the control output to be activated at the time of emergency broadcast\*.

Perform this in the "Control output pattern setting."

Zone	Base pattern	General broadcast	Control output	Emergency sequence	Emergency broadcast	Emergency broadcast status interlocking
No.	1		Paste	Copy		
Name	Control output pattern 1					
ALL						
VX-3004F(ID:0)	ATT/COU 0-1	ATT/COU 0-2	ATT/COU 0-3	ATT/COU 0-4	ATT/COU 0-5	
	COU 0-9	COU 0-10	COU 0-11	COU 0-12	COU 0-13	
VX-3008F(ID:1)	ATT/COU 1-1	ATT/COU 1-2	ATT/COU 1-3	ATT/COU 1-4	ATT/COU 1-5	
	COU 1-9	COU 1-10	COU 1-11	COU 1-12	COU 1-13	
VX-3016F(ID:2)	ATT/COU 2-1	ATT/COU 2-2	ATT/COU 2-3	ATT/COU 2-4	ATT/COU 2-5	
	ATT/COU 2-9	ATT/COU 2-10	ATT/COU 2-11	ATT/COU 2-12	ATT/COU 2-13	
	COU 2-17	COU 2-18	COU 2-19	COU 2-20	COU 2-21	

\* Perform this setting as needed.

#### 5. Set the Emergency Sequences.

Perform this in the "Emergency sequence pattern setting."

Zone	Base pattern	General broadcast	Control output	Emergency sequence	Emergency broadcast
No.	1		<input type="checkbox"/> Use extended mode	Paste	Copy
Name	Emergency sequence 1				
EV Broadcast from	VX-3004F(ID:0)				
Open all Close all					
Phase 1					
Message	Message 1		Alert		
Duration	Endless				

#### 6. Set the emergency broadcast patterns.

Perform this in the "Emergency broadcast pattern setting."

Zone	Base pattern	General broadcast	Control output	Emergency sequence	Emergency broadcast	Emergency broadcast status interlocking
No.	1		Paste	Copy		
Name	Emergency pattern 1					
Sequence	001: Emergency sequence 1					
Open all Close all						
Phase 1						
Message	Alert		Output	<input checked="" type="radio"/> Individual zone <input type="radio"/> Pattern		
	Message 1			ZONE 0-1		
Duration	Endless		Control output	001: Control output pattern 1		

To the next page

From the previous page

7. Assign each function to be used at the time of emergency broadcast to the control inputs of the VX-3000F or to the key on the remote microphone.

Perform this in the "Event settings."

Control input	RM	VX-3000CT setting	Fault LED setting	Audio network output setting	
Control input		Unit number VX-3004F(ID:0)	Paste	Copy	
Name	Function	Polarity	Related control output	Contents1	Contents2
1 CIN 0-1	Emergency broadcast pattern start	NO		Emergency pattern 1	None
2 CIN 0-2	Emergency broadcast pattern stop	NO		Emergency pattern 1	
3 CIN 0-3	Emergency reset	NO		No restoration message	

## [Emergency broadcast pattern configuration]

Emergency broadcast pattern	Emergency sequence	Phase 1	Phase 2	Phase 3
		EV message + broadcast duration	EV message + broadcast duration	EV message + broadcast duration
	Output zone	Individual or pattern (multiple zones)	Individual or pattern (multiple zones)	Individual or pattern (multiple zones)
	Control output pattern	Multiple control outputs	Multiple control outputs	Multiple control outputs

## [Emergency broadcast setting example]

## • Emergency sequence settings

Emergency sequence 1	Phase 1	Phase 2	Phase 3
	EV message 1, 5-minute broadcast	EV message 2, Continuous broadcast	—

**Note:** Phase 3 is not set in this example.

## • EV message settings

Message name	Audio file	Type
EV message 1	sign001.wav	Alert
EV message 2	sign002.wav	Evacuation

## • Output zone pattern setting

		Zones VX-3004F's speaker outputs			
		1	2	3	4
Output zone pattern (No.)	1	✓			
	2	✓	✓	✓	✓

• Control output pattern settings

Control output pattern (No.)	1	VX-3004F's control outputs 1
	2	VX-3004F's control outputs 2

• Emergency broadcast pattern settings

Emergency broadcast pattern 1	Emergency sequence	Emergency sequence 1		
		Phase 1	Phase 2	Phase 3
	Output zone	Output zone pattern 1	Output zone pattern 2	——
	Control output pattern	Control output pattern 1	Control output pattern 2	——

[Operation example]

The example here assumes that a fire breaks out in zone 1.

- (1) When the fire alarm sensor installed in zone 1 works, the automatic fire alarm system transmits a control signal to the VX-3000 system's control input. Then, the emergency broadcast pattern 1 is activated, allowing the alert message to be broadcast to zone 1. In this event, VX-3004F's control outputs 1 turns ON. (Phase 1)

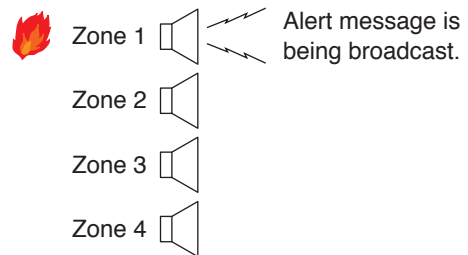

- (2) After 5 minutes, phase 1 is shifted to phase 2 and the "Evacuation" EV message is broadcast to all zones. In this event, VX-3004F's control output 1 turns OFF, while VX-3004F's control output 2 turns ON.

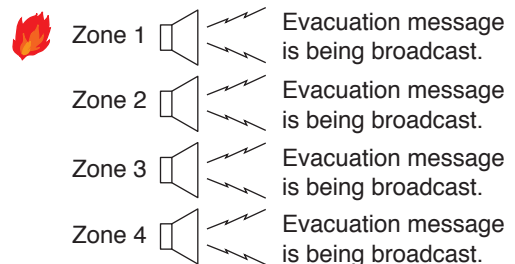

### 3.8. Surveillance Function

Surveillance function continuously monitors such status at the major points from input to output of the system as each unit operation, cable connections or communications between the units, and power supply.

If a unit fails or cable breaks, this is notified to the system operator by some means. Failure status of the external equipment can also be accepted and notified.

When a failure has occurred, perform a set of operations: failure reception first to acknowledge failure state and finally failure reset to restore the system to normal using the keys on the remote microphone or control input terminals of the VX-3000F. It is also possible to notify the failure occurrence or failure reset by e-mail.

Set the Surveillance intervals, intended surveillance points, and actions at the time of failure occurrence using the VX-3000 Setting software.

To use the Surveillance function, follow the procedures below to perform each setting.

#### Note

The surveillance function cannot be assigned to the VX-3000PM's control input and the VX-3000CT's function key.

#### 1. Set the surveillance function to "Used."

Perform this in the "Basic settings."

Common settings

Setting for fault detect functions **Used**

Fault auto reset setting Auto reset

#### 2. Set the surveillance points of each device.

Perform this in the "Surveillance settings."

Battery check Start time: None Interval: Every 4 hours

External ATT check Start time: None Interval: Every 4 hours

Amplifier / SP line inspection (in case of AC fault) Start time: None Interval: Every 100 seconds

Individual setting

ALL

VX-3004F(ID:0) ALL

Main unit

- Analog LINK
- LAN A
- LAN B

DC Power

Amplifier

- Ch1
- Ch2
- Ch3
- Ch4

RM ALL

- ID:0

Control input ALL

- 1
- 2
- 3
- 4
- 5

Speaker

	open	short	earth
1	<input checked="" type="checkbox"/>	<input checked="" type="checkbox"/>	<input checked="" type="checkbox"/>
2	<input checked="" type="checkbox"/>	<input checked="" type="checkbox"/>	<input checked="" type="checkbox"/>
3	<input checked="" type="checkbox"/>	<input checked="" type="checkbox"/>	<input checked="" type="checkbox"/>
4	<input checked="" type="checkbox"/>	<input checked="" type="checkbox"/>	<input checked="" type="checkbox"/>

#### 3. Set the control outputs to be activated at the time of failure detection. \*

Perform this in the "Control output pattern setting."

Zone Base pattern General broadcast **Control output** Emergency sequence Emergency broadcast Emergency broadcast

No. 1 Paste Copy

Name Control output pattern 1

ALL

VX-3004F(ID:0)	COUT 0-1	COUT 0-2	COUT 0-3	COUT 0-4	COUT 0-5
	COUT 0-9	COUT 0-10	COUT 0-11	COUT 0-12	COUT 0-13
VX-3008F(ID:1)	COUT 1-1	COUT 1-2	COUT 1-3	COUT 1-4	COUT 1-5
	COUT 1-9	COUT 1-10	COUT 1-11	COUT 1-12	COUT 1-13
VX-3016F(ID:2)	COUT 2-1	COUT 2-2	COUT 2-3	COUT 2-4	COUT 2-5
	COUT 2-9	COUT 2-10	COUT 2-11	COUT 2-12	COUT 2-13
	COUT 2-17	COUT 2-18	COUT 2-19	COUT 2-20	COUT 2-21

To the next page

\* Perform this setting as needed.

From the previous page

#### 4. Set the e-mail function to send an e-mail notification at the time of failure occurrence or failure reset, and register e-mail addresses.\*

Perform this in the "Surveillance mail settings."

No.	Delete	Name	Mail address
1	Delete		
2	Delete		
3	Delete		
4	Delete		
5	Delete		
6	Delete		
7	Delete		
8	Delete		
9	Delete		
10	Delete		
11	Delete		
12	Delete		
13	Delete		
14	Delete		
15	Delete		
16	Delete		
17	Delete		
18	Delete		
19	Delete		

\* Perform this setting as needed.

#### 5. Select the surveillance target devices or the surveillance points in the VX-3000 system.

Perform this in the "Failure pattern setting."

Zone	Base pattern	General broadcast	Control output	Emergency sequence	Emergency broadcast	Emergency broadcast status interlocking	Failure
No.	1						
Name	Failure output pattern 1						
System Fault	DC Power	VX-LINK	RS-LINK	DS-LINK	DC-FUSE		
VX unit fault	VX-3004F(ID:0)	VX-3008F(ID:1)	VX-3016F(ID:2)				
ALL							
RM fault							
VX-3004F(ID:0)	VX0-RM0						

To the next page

From the previous page

## 6. Assign the "External failure input" function to the control input of the VX-3000F.\*

Perform this in the "Failure pattern setting."

ID	Terminal number
VX-3004F(ID:0)	CIN 0-1
VX-3004F(ID:0)	CIN 0-1
VX-3008F(ID:1)	CIN 1-1
VX-3016F(ID:2)	CIN 2-1

## 7. Select the failure status output destination from the preprogrammed control output patterns in order to signal the failure occurrence or failure reset by way of the control output.\*

Perform this in the "Failure pattern setting."

Control method: Invert  
Failure status output to: 001: Control output pattern 1

## 8. Select the address to which an e-mail notification is sent at the time of failure occurrence or failure reset from the registered mail addresses, or select the name of the mailing list.\*

Perform this in the "Failure pattern setting."

Mail destination:  Individual  Mailing list  
VX-3004F <VX-3004F@toa.co.jp>

## 9. Assign the fault acknowledge and fault reset functions to the control inputs of the VX-3000F or the keys on the remote microphone.

Perform this in the "Event settings."

Name	Function	Polarity	Related control output	Contents1
1 CIN 0-1	External failure input			Failure when turning it on
2 CIN 0-2	Fault acknowledge			
3 CIN 0-3	Fault reset			

\* Perform these settings as needed.

**[Failure pattern configuration]**

Failure output pattern	Surveillance target	Each device, each surveillance point (Set the surveillance points of each device in the VX-3000 system in the Surveillance settings individually.)
	External failure input	Control input terminal
	Failure state output	Control output pattern (Multiple control outputs)
	Send mail settings	Select the e-mail destination from "Individual" or "Mailing list."

**[Example of assigning the Surveillance function to the remote microphone]**• **Surveillance individual settings**

	Surveillance point				
	VX LINK	DC POWER	-----	Control input 1	-----
VX-3004F (ID: 0)	✓	✓	-----	✓	-----
VX-3004F (ID: 1)	✓	✓	-----	—	-----

• **Control output pattern settings**

Control output pattern (No.)	3	VX-3004F's control outputs 3 and 4
	4	VX-3004F's control outputs 5 and 6

• **Remote microphone's function key settings**

Key	Function	Contents		
Function key 1	Failure output receipt	Failure output pattern 1	Surveillance target	VX-3004F (ID: 0)
			External failure input	None
			Failure status output	Control output pattern 3
Function key 2	Failure output receipt	Failure output pattern 2	Surveillance target	Control line
			External failure input	None
			Failure status output	Control output pattern 4
Function key 3	Failure output reset	—		

### 3.9. ANC Function

An ANC (Ambient Noise Control) function is a function to control the broadcast volume so that announcements or BGM can be broadcast at appropriate volume level in accordance with the ambient noise by measuring its level with the sensor microphone installed in the broadcast zone.

This function will accurately measure only noises by distinguishing noises from the VX-3000 system's output sound (announcements or BGM) in broadcast zones.

Even during announcements or BGM, it is possible to perform real-time volume control in response to the ambient noise change.

Note the ANC function is disabled for an emergency broadcast.

To use the ANC function, connect a microphone for measuring ambient noise to the VX-3000F, and measure the ambient noise level at the system installation, then set the reference value of the sensor level.

If the ambient noise level during operation differs from that measured at installation, perform the setting to correct the reference value of the sensor level.

#### Notes

- When setting the ANC for the channel where the VOX function is in use, the VOX function is set to OFF.
- The ANC setting applies to a single or multiple Audio output channel numbers preset within the unit. ANC setting cannot be made for other units.
- The sensor microphone cannot be connected to the VX-3000PM's audio input.

VX-3004F

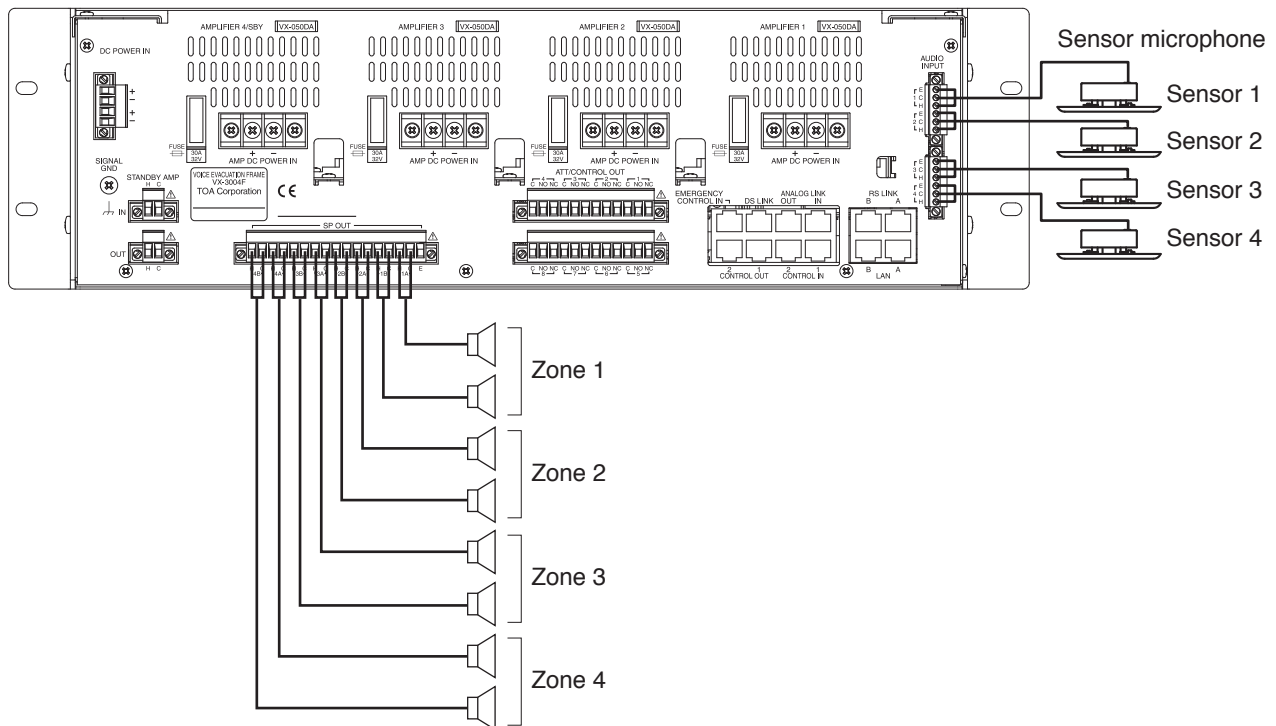

[Setting example 1]

Zone \ Sensor microphone	Zone 1	Zone 2	Zone 3	Zone 4
Sensor 1	Applicable	—	—	—
Sensor 2	—	Applicable	—	—
Sensor 3	—	—	Applicable	—
Sensor 4	—	—	—	Applicable

[Setting example 2]

Zone \ Sensor microphone	Zone 1	Zone 2	Zone 3	Zone 4
Sensor 1	Applicable	Applicable	—	—
Sensor 3	—	—	Applicable	Applicable

### 3.9.1. Settings to perform at installation

To use the ANC function, follow the procedures below to perform each setting.

1. Set "Purpose" of the VX-3000F's Audio input channel to which a sensor microphone is to be connected to "ANC (LINE)" or "ANC (MIC)," then set ON or OFF of the phantom power.

Perform these settings on the VX-3000F's "Settings for audio input" screen in the "Unit configuration settings."

VX-3004F(ID:0)					
VX configuration setting		Settings for audio input		Settings for audio out	
-	Name	Purpose	Phantom power	Input Mix	
AUDIO IN1	Analog 0-1	LINE		AUDIO IN1	
AUDIO IN2	Analog 0-2	LINE		AUDIO IN2	
AUDIO IN3	Analog 0-3	MIC		AUDIO IN3	
AUDIO IN4	Analog 0-4	ANC1(LINE)		AUDIO IN4	
		ANC1(MIC)			

2. Apply the ANC setting set in Step 1 to a single or multiple zones within the same VX-3000F.

Perform this setting on the VX-3000F's "Settings for audio output" screen in the "Unit configuration settings."

VX-3004F(ID:0)							
VX configuration setting		Settings for audio input		Settings for audio output		Settings for terminals	
-	Name	Zone setting	ATT setting	EOL setting	ANC Sensor		
Zone1	ZONE 0-1	AB zone use	Not used	Not used	ANC1		
Zone2	ZONE 0-2	AB zone use	Not used	Not used	ANC2		
Zone3	ZONE 0-3	AB zone use	Not used	Not used	ANC3		
Zone4	ZONE 0-4	AB zone use	Not used	Not used	ANC4		

3. Set "ON/OFF," "Sample time," "Max Level," "Min Level," and "Gain Ratio" to the ANC Sensor set to the corresponding zone in Step 2.

Perform them in the "Sound settings (ANC)."

IN		OUT		ANC							
Unit: VX-3004F(ID:0) [Paste] [Copy] [Initialize]											
No.	On/Off	Sample time(sec)		Max Level(dB)		Min Level(dB)		Gain Ratio		Adjust Zero(dB)	
1	Off	▼	20 ▲	▼	0 ▲	▼	-6 ▲	▼	3:3 ▲	▼	0 ▲

To the next page

From the previous page

4. Place the VX-3000F and a PC in online state, and measure the reference value of the sensor level, then confirm each output volume when the maximum output level and the minimum level are applied.

Perform this setting on the VX-3000F's ANC setting screen in the Maintenance screen.

	ANC1	ANC2	ANC3	ANC4
Target	<input checked="" type="checkbox"/>	<input checked="" type="checkbox"/>	<input checked="" type="checkbox"/>	<input checked="" type="checkbox"/>

5. If the sound volume confirmed in Step 4 is not appropriate, reset the Max Level and/or Min Level.

Perform them in the "Sound settings (ANC)."

No.	On/Off	Sample time(sec)	Max Level(dB)	Min Level(dB)	Gain Ratio	Adjust Zero(dB)
1	Off	20	0	-6	3:3	0

6. Repeat Steps 4 and 5 until the Max Level and/or Min Level become an appropriate level.

### 3.9.2. Settings to perform after installation completion as needed

If the reference value\* differs from the actual minimum noise level, there may be a situation that the output sound is extremely loud though the ambient noise is quiet. In such cases, correct the reference value of Sensor level.

In such cases, correct the reference value of Sensor level using the VX-3000 Setting software.

\* The minimum noise level that has been measured in **Step 3** on p. 3-25 is defined as reference value "ZERO level."

#### 1. Place the VX-3000F and a PC in online state, then acquire the sensor level and reference noise level.

Perform Sensor level and reference noise level acquisition on the VX-3000F's ANC Reference screen in the Maintenance screen.

Equipment		
VX-3004F(ID:0)		
	Sensor level (dB)	Reference noise level (dB)
ANC1	-86	-86
ANC2	-89	-89
ANC3	-87	-87
ANC4	-88	-88

#### 2. Reset the Adjust Zero value of the Audio input channel where the reference value of the sensor level differs from the actual minimum noise level.

Perform them in the "Sound settings (ANC)."

IN			OUT			ANC		
Unit: VX-3004F(ID:0) [Paste] [Copy] [Initialize]								
No.	On/Off	Sample time(sec)	Max Level(dB)	Min Level(dB)	Gain Ratio	Adjust Zero(dB)		
1	Off	20	0	-6	3:3	0		

When setting the Adjust Zero value, refer to "Example about the preset minimum ambient noise level and the actual level" ([the next page](#)).

#### Note

If the ANC function is set to ON, a specific sound source like chime tone may not be output normally in rare cases.

This symptom may possibly happen when the measuring frequency of the ANC function and the frequency of the sound source not correctly output are identical. To solve this problem, change the measuring frequency of the ANC function.

Then, retry **Steps 4 and 5** on p. 3-26 and **Steps 1 and 2** above.

Normally, the measuring frequency is not displayed on the screen. Enter the Advanced mode with the procedures below, then change the frequency.

(1) Press the "Ctrl + Shift + A" keys simultaneously with the Sound settings (ANC) screen displayed.

The unit is placed in Advanced mode and frequencies will appear.

(2) Change one of the frequencies which seem to be identical with the frequency of the audio source not correctly output.

Perform this setting in the "Sound settings (ANC)."

No.	On/Off	Sample time(sec)	Max Level(dB)	Min Level(dB)	Gain Ratio	Adjust Zero(dB)	Freq.1 (Hz)	Freq.2 (Hz)	Freq.3 (Hz)
ANC	Off	20	0	-6	3:3	0	210	550	1.08k
	Off	20	0	-6	3:3	0	210	550	1.08k
	Off	20	0	-6	3:3	0	210	550	1.08k
	Off	20	0	-6	3:3	0	210	550	1.08k

Be sure to keep the conditions below when changing the frequency.

- Freq. 1 < Freq. 2 < Freq. 3
- Freq. 2 – Freq. 1 ≥ 30 Hz
- Freq. 3 – Freq. 2 ≥ 30 Hz

- (3) Perform **Steps 4 and 5** on p. 3-26 and **Steps 1 and 2** on the previous page.
- (4) If the symptom still continues, return the frequency to the default value. Then, change the frequencies one by one, performing **Steps 4 and 5** on p. 3-26 and **Steps 1 and 2** on the previous page at each time.
- (5) When the symptom is improved, press the "Ctrl + Shift + A" keys simultaneously with the Sound settings (ANC) screen displayed.  
The unit exits the Advanced mode and the frequency will be hidden.

**Example about the preset minimum ambient noise level and the actual level**

The explanations below are based on the assumption that the maximum output level (Max Level), minimum output level (Min Level), and gain ratio (Gain Ratio) are as follows: Max Level = 0 dB, Min Level = -12 dB, and Gain Ratio = 3:3.

**[When the preset minimum ambient noise level is the same as the actual level]**

No correction is needed.

The diagram below shows the relationship among the ambient noise level, sensor level, and output level.

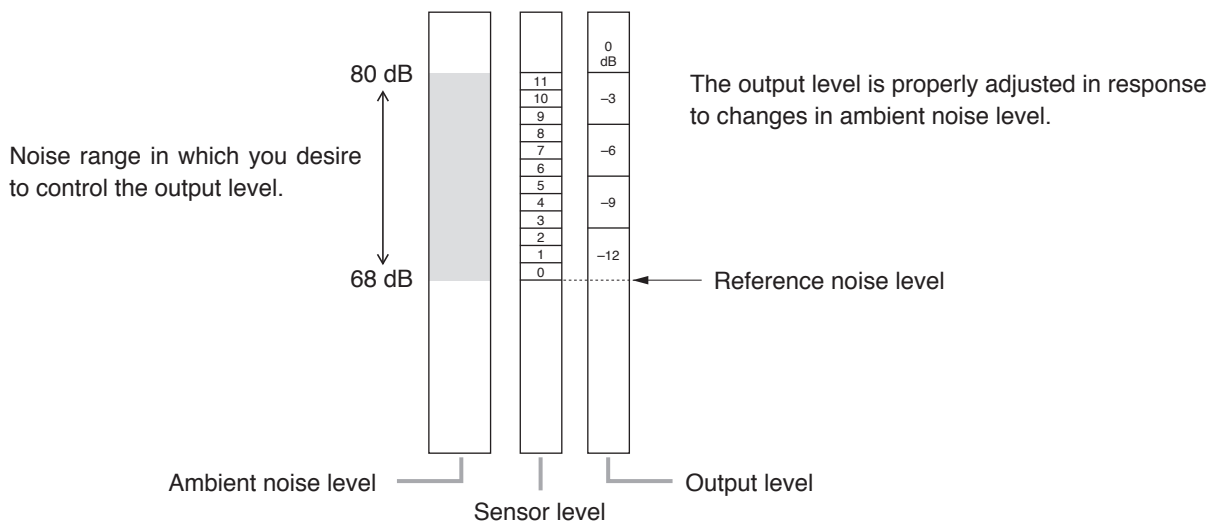

**[When the preset minimum ambient noise level is extremely lower than the actual level]**

In this case, the unit recognizes that the ambient noise is high even in low ambient noise condition (A) where the unit is actually used, providing sound output at high level (-3 dB in this example).

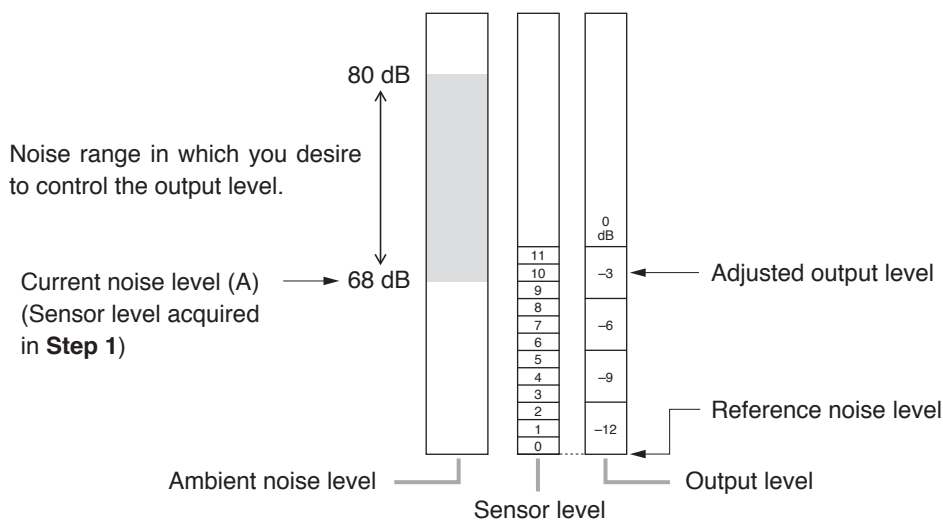

Correct the "Adjust ZERO" value to a higher level to obtain the optimum operation according to the cases (1) and (2) on the next page.

- (1) If the current noise level (A) is the minimum ambient noise level when the unit is actually used, increase the "Adjust ZERO" value so that the Sensor level becomes "0."

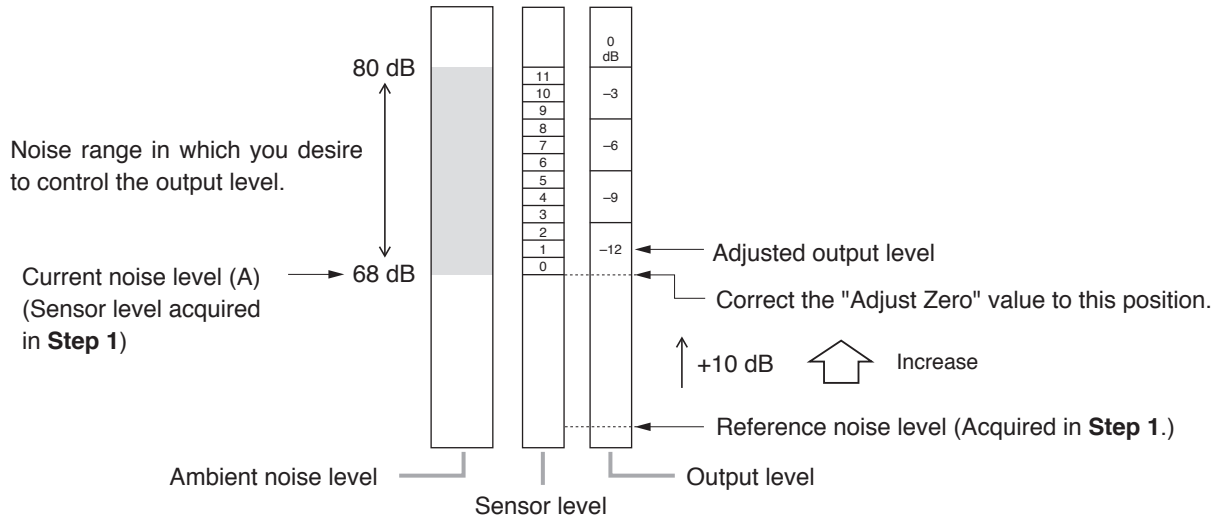

- (2) If the current noise level (A) is not the minimum ambient noise level when the unit is actually used, correct the "Adjust Zero" value so that the output level becomes the desired level.

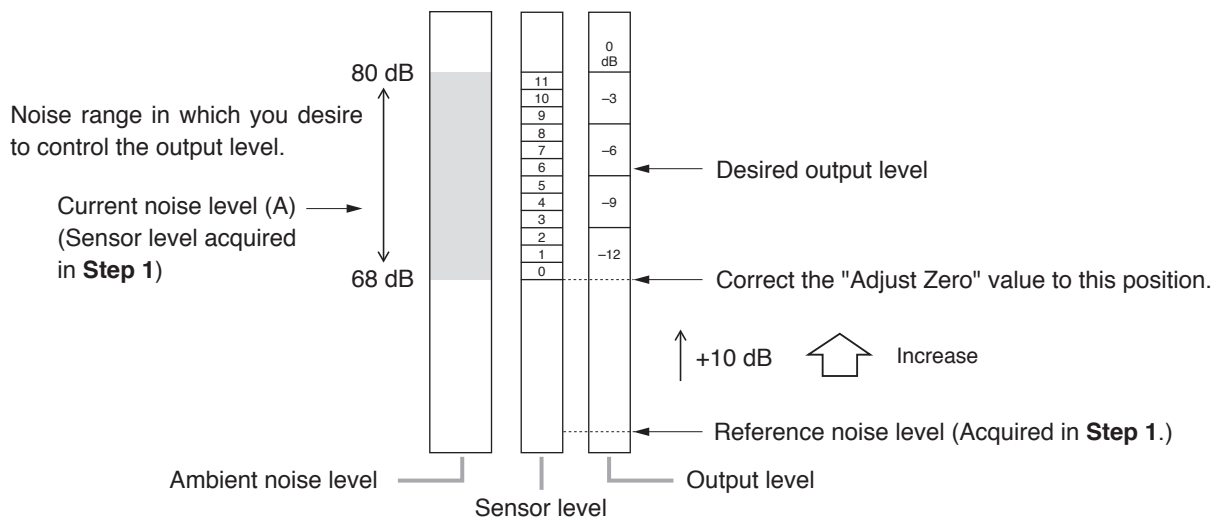

**[When the preset minimum ambient noise level is extremely higher than the actual level]**

Correct the "Adjust Zero" value to a lower level to obtain the optimum operation.

### 3.10. VOX Function

A VOX function is a function to automatically output the audio input signals to the set zone by detecting audio input signal level.

It starts or stops outputting the audio input signals to the designated output zone in response to audio input signal level.

Control signal output is started when the VOX gate is open, and stopped when closed.

The VOX gate opens when the audio input signal level exceeds the sum level of the threshold level and the hysteresis setting value.

Once open, the VOX gate closes after the time set in Hold time elapses when the audio input signal level decreases below the level obtained by subtracting the hysteresis setting value from the threshold level.

The control signal output is performed in response to input signal level as shown below.

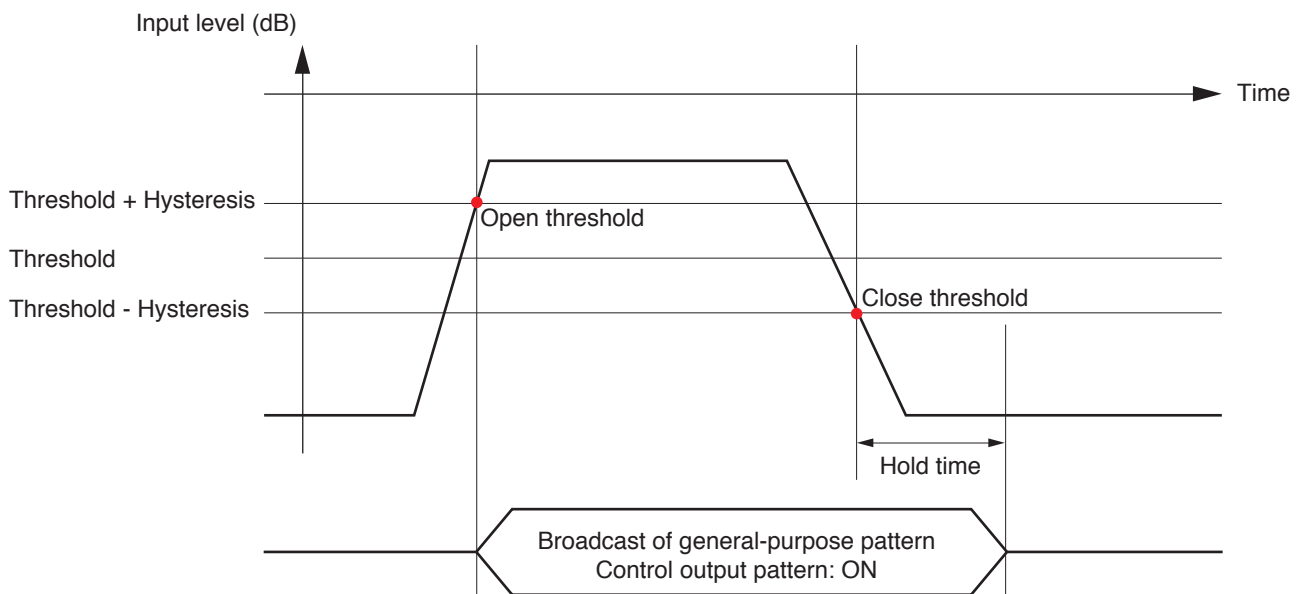

Set the VOX function on/off, threshold, hysteresis, and hold time on the Sound settings (input) screen.

Control output pattern can also be activated in synchronization with the audio input.

Broadcast zone can be set to individual output zone or zone pattern.

#### Note

When any one of the channels to which "Input Mix" is set (p. 3-148) becomes in open state, such channel is allowed for broadcast.

To make broadcasts using the VOX function, perform the settings on the VX-3000 Setting software as described below.

**1. Set the priority level.**

Set the broadcast priority level for each sound source on the Priority settings screen.

**2. Set the output zone pattern. (Only when using the output zone pattern)**

Perform this in the "Zone pattern setting."

Zone	Base pattern	General broadcast	Control output	Emergency sequence	Emergency broadcast	Em
No.	◀ 1 ▶		Paste	Copy		
Name	Zone pattern 1					
ALL						
VX-3004F(ID:0)	ZONE 0-1	ZONE 0-2	ZONE 0-3	ZONE 0-4		
VX-3008F(ID:1)	ZONE 1-1	ZONE 1-2	ZONE 1-3	ZONE 1-4		
VX-3016F(ID:2)	ZONE 2-1	ZONE 2-2	ZONE 2-3	ZONE 2-4		
	ZONE 2-9	ZONE 2-10	ZONE 2-11	ZONE 2-12		

**3. Set the control output patterns. (Only when using the control output patterns)**

Set the control output to be interlocked with the control input or key operation. Perform this in the "Control output pattern setting."

Zone	Base pattern	General broadcast	Control output	Emergency sequence	Emergency broadcast	Emergency broadcast
No.	◀ 1 ▶		Paste	Copy		
Name	Control output pattern 1					
ALL						
VX-3004F(ID:0)	ATT/COU 0-1	ATT/COU 0-2	ATT/COU 0-3	ATT/COU 0-4	ATT/COU 0-5	
	COU 0-9	COU 0-10	COU 0-11	COU 0-12	COU 0-13	
VX-3008F(ID:1)	ATT/COU 1-1	ATT/COU 1-2	ATT/COU 1-3	ATT/COU 1-4	ATT/COU 1-5	
	COU 1-9	COU 1-10	COU 1-11	COU 1-12	COU 1-13	
VX-3016F(ID:2)	ATT/COU 2-1	ATT/COU 2-2	ATT/COU 2-3	ATT/COU 2-4	ATT/COU 2-5	
	ATT/COU 2-9	ATT/COU 2-10	ATT/COU 2-11	ATT/COU 2-12	ATT/COU 2-13	
	COU 2-17	COU 2-18	COU 2-19	COU 2-20	COU 2-21	

**4. Assign the VOX function to the audio input channel of the VX-3000F or VX-3000PM.**

Enable the VOX function of the audio input channel to which the VOX function is assigned. Set each item of the VOX function. Set the control output pattern to activate synchronously. Set the broadcast destination output zone or zone output pattern. Conduct these settings on the Sound settings (input) screen (p. 3-148).

VOX	On/Off	Threshold(dB)	Hysteresis(dB)	Hold time(msec)	Related control output	Broadcast type	Broadcast zone
	Off	▼ -20 ▲	▼ 0 ▲	▼ 2000 ▲	None	Individual zone	ZONE 0-1

### 3.11. Network Area Division Function

The network area division function allows you to build up to 8 network areas in a single VX-3000 system, enabling broadcast among different network areas to be made using a unicast audio stream.

To make broadcast among network areas, add the VX-3000PM within the system, then use the VX-3000PM's unicast stream output. The VX-3000PM has 7 unicast stream outputs. A single VX-3000PM unit can be connected to a single VX-3000F unit.

The procedures below show the settings required to make broadcast among network areas.

#### 1. Set the network area division function to "Used."

Perform this in the "Basic settings."



Settings for using the network area division function

Used

#### 2. Set a network area to the VX-3000F.

Perform this in the "Unit configuration settings."



Network area

NetworkArea 0

#### 3. Add the VX-3000PM.

Perform this in the "Unit configuration settings."

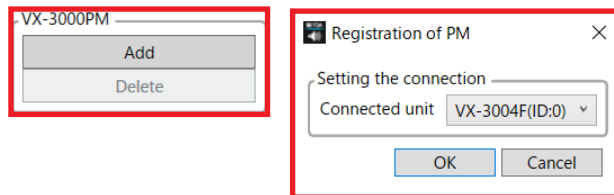

VX-3000PM

Add

Delete

Registration of PM

Setting the connection

Connected unit: VX-3004F(ID:0)

OK Cancel

#### 4. Perform settings to each audio input of the VX-3000PM to use broadcast among networks.

Perform these settings on the VX-3000PM's "Settings for audio input" screen in the "Unit configuration settings."

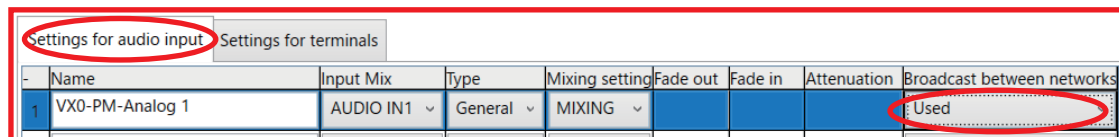

Settings for audio input

Settings for terminals

	Name	Input Mix	Type	Mixing setting	Fade out	Fade in	Attenuation	Broadcast between networks
1	VX0-PM-Analog 1	AUDIO IN1	General	MIXING				Used

To the next page

From the previous page



**5. Set the network area where the audio input enabled for broadcast among network areas can be broadcast.**

Perform this setting in the "Broadcast setting between networks" in the "Pattern settings."

Zone		Broadcast setting between networks		
<b>Broadcast setting between networks</b>				
VX-3000PM unit	AUDIO IN	NetworkArea 0	NetworkArea 1	NetworkArea 2
VX-3000PM(VX0)	VX0-PM-Analog 1		<input checked="" type="checkbox"/>	<input checked="" type="checkbox"/>
VX-3000PM(VX0)	VX0-PM-Analog 2		<input checked="" type="checkbox"/>	<input checked="" type="checkbox"/>
VX-3000PM(VX0)	VX0-PM-Analog 3		<input checked="" type="checkbox"/>	<input checked="" type="checkbox"/>
VX-3000PM(VX1)	VX1-PM-Analog 1	<input checked="" type="checkbox"/>		<input checked="" type="checkbox"/>
VX-3000PM(VX2)	VX2-PM-Analog 1	<input checked="" type="checkbox"/>	<input checked="" type="checkbox"/>	

**Note**

When the network area division function is in use, the VX-3000F's audio input or the microphone announcement (using TALK or AUX) from the remote microphone can be broadcast to only the VX-3000F installed in the same area.

The broadcasts to the different network area of the general broadcast, the base pattern broadcast, and the emergency warning broadcast are enabled by setting them to only the EV sound source, or the VX-3000PM's audio input that is available to broadcast to the target network area.

## 4. SETTING ITEMS

Setting item buttons are located in the left side portion of the screen.

The entire system setting is divided into 14 steps of settings starting with "Basic settings" to "Timer Setting" from upper to lower. Be sure to make settings in this order.

Clicking on each setting item button displays the corresponding setting screen in the main area in the right side portion of the setting item buttons.

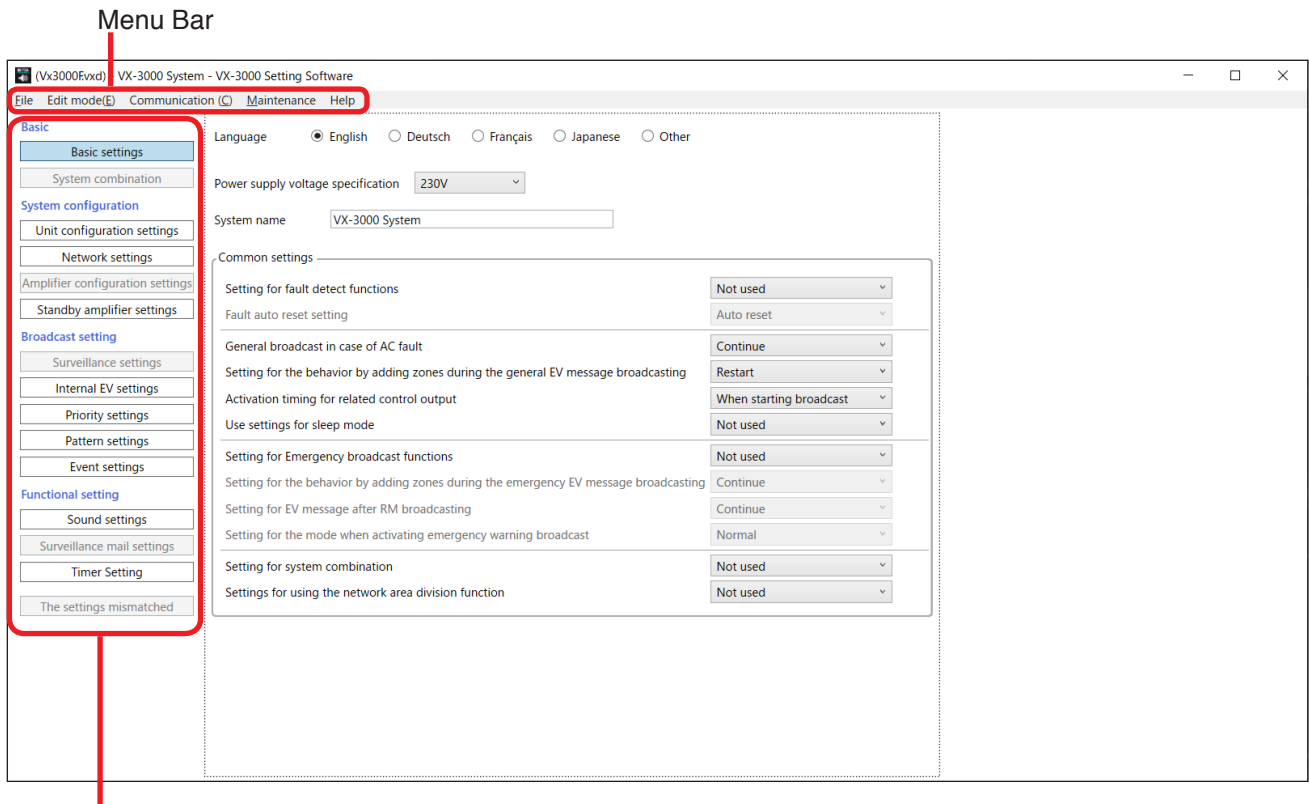

Setting Item Buttons

### 4.1. Setting Item Button Configuration

#### 4.1.1. Basic

Basic settings:

- Language: Select the displayed language.
- Power supply voltage specification: Select the power supply voltage specification.
- System name: Set the desired system name.
- Common settings: Make settings related to the Surveillance function, the Emergency broadcast, and the network area division.

System combination: Perform this setting when 41 to 160 VX-3000F units are used.  
(See [p. 3-40.](#))

#### 4.1.2. System configuration

- Unit configuration settings: Set the unit configuration of the VX-3000F, remote microphones, VX-3000PM, and VX-3000CT.
- Network settings: Perform the VX-3000F's, VX-3000PM's, and VX-3000CT's network setting.
- Amplifier configuration setting: Perform the configuration of 2 amplifier modules to be installed to the VX-3008F and output zones.
- Standby amplifier settings: Perform each VX-3000F's standby amplifier sharing setting.

### 4.1.3. Broadcast setting

Surveillance settings:	Set the start time and interval time for confirming failure status. Set each device's individual points to be detected for failure.
Internal EV setting:	
Registration:	Register the sound source files to be used as EV messages or chime sound source.
EV message setting:	Set application and combination of the EV message.
Chime setting	Set the sound source files as chime sound source.
Priority settings:	Set the priority levels for General-purpose, Emergency, BGM, and Emergency warning broadcasts.
Pattern settings:	
Zone:	Set broadcast zones as Output zone pattern.
Broadcast setting between networks:	Set the VX-3000PM's audio input that is used for broadcast among networks to which network area the broadcast is made.
Base pattern:	Set BGM broadcast zones as Base pattern.
General broadcast:	Set General-purpose broadcast zones as General broadcast pattern.
Control output:	Set the control outputs to use as Control output pattern.
Emergency sequence:	Set the sequence of Emergency broadcast.
Emergency broadcast:	Register a set of Emergency sequence, output zone, and control output pattern as Emergency broadcast pattern.
Emergency broadcast status interlocking:	Set the control output pattern that is interlocked with the VX-3000 system's emergency broadcast state.
Failure:	Set detection points for failure as Failure pattern.
Event settings:	
Control input:	Assign functions to the control inputs.
RM:	Assign functions to the keys of remote microphone.
VX-3000CT setting:	Assign functions to the volume controls and the function keys of the VX-3000CT.
Fault LED setting:	Set the Failure pattern to be shown on each Fault indicator.
Audio network output setting:	Set which audio signals being output to the VX-3000F's zones to be output to the NX-300 network audio adapter.

### 4.1.4. Functional setting

Sound settings:	Adjust the sound and volume of the VX-3000F's input/output and the VX-3000PM's audio input. When using the ANC function, also perform settings for the output side of the ANC function.
Surveillance mail settings:	Perform the settings concerning the function to send an e-mail notification when a failure has occurred or has been reset.
Timer setting:	To create weekly and holiday programs, register the daily event schedule as a daily program, then assign the daily program to each day of the week and the set holiday period.
The settings mismatched:	Check for errors in the setting.

## 4.2. Menu Bar

### 4.2.1. File

New:	Creates a new data file to be used by the VX-3000 Setting software.
------	---

**Open:** Reads an existing data file (Extension: vxd) to be used by the VX-3000 Setting software. The read data file name and system name appear in the title bar on the setting screen.

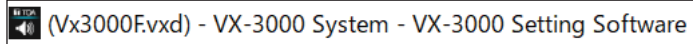

**Save:** Saves the information currently being edited by the VX-3000 Setting software and overwrites an existing data.

**Save as:** Saves the information currently being edited by the VX-3000 Setting software under a new file name.

**Data output:**

Setting data: Saves the setting data in CSV format.

RM label: Creates and prints labels used to identify the keys on remote microphones (RM-200SF, RM-320F, RM-300X, and RM-210F).

**Exit:** Quits the VX-3000 Setting software.

#### 4.2.2. Edit mode

Simple mode: Switches to the Simple mode.

Normal mode: Switches to the Normal mode.

#### 4.2.3. Communication

Setting data & Audio source upload (PC->VX): Writes setting data and sound sources to the VX-3000F.

Setting data & Audio source download (VX->PC): Reads setting data and sound sources from the VX-3000F.

Timer setting data upload (PC->VX): Writes only the timer setting data to the VX-3000F.

#### 4.2.4. Maintenance

Maintenance: Shows the maintenance screen. (See [p. 3-170.](#))

Unit detection & network settings: Detect the devices connected to the local network and perform the network settings for them. (See [p. 3-205.](#))

#### 4.2.5. Help

User authentication setting: (Only when the software is started with the Administrator authority)  
The password that has been set for each access authorization of the VX-3000 Setting software can be changed.

Version: Displays the version number of the VX-3000 Setting software.

## 5. CREATE A NEW SETTING PROJECT FILE

**Step 1.** Select [File] → [New] from the menu bar.  
The new creation screen appears.

**Step 2.** Enter the number of the VX-3000F units (with amplifier).  
Enter the number from "0" to "40."  
Default settings are as follows.

VX-3004F: 1  
VX-3008F: 0  
VX-3016F: 0

**Notes**

- The total number of the units must be set in the range of 1 to 40.
- Up to 40 VX-3000F units including the extension units can be used in a system.

**Step 3.** Select the specification of power supply voltage.  
Default setting is "230 V."

**Step 4.** Click the OK button.  
The setting is reflected to the Unit configuration settings screen.

**Step 5.** Click the button from the top (Basic settings) of the menu items to the bottom in turn and perform necessary settings on each corresponding screen.

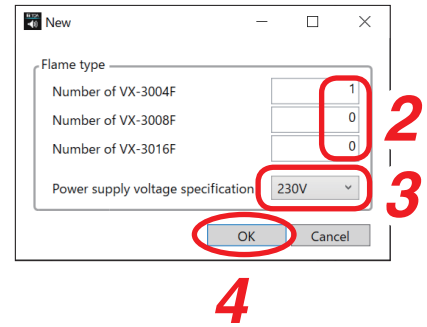

## 6. BASIC SETTINGS

Clicking the Basic settings button displays the screen below.

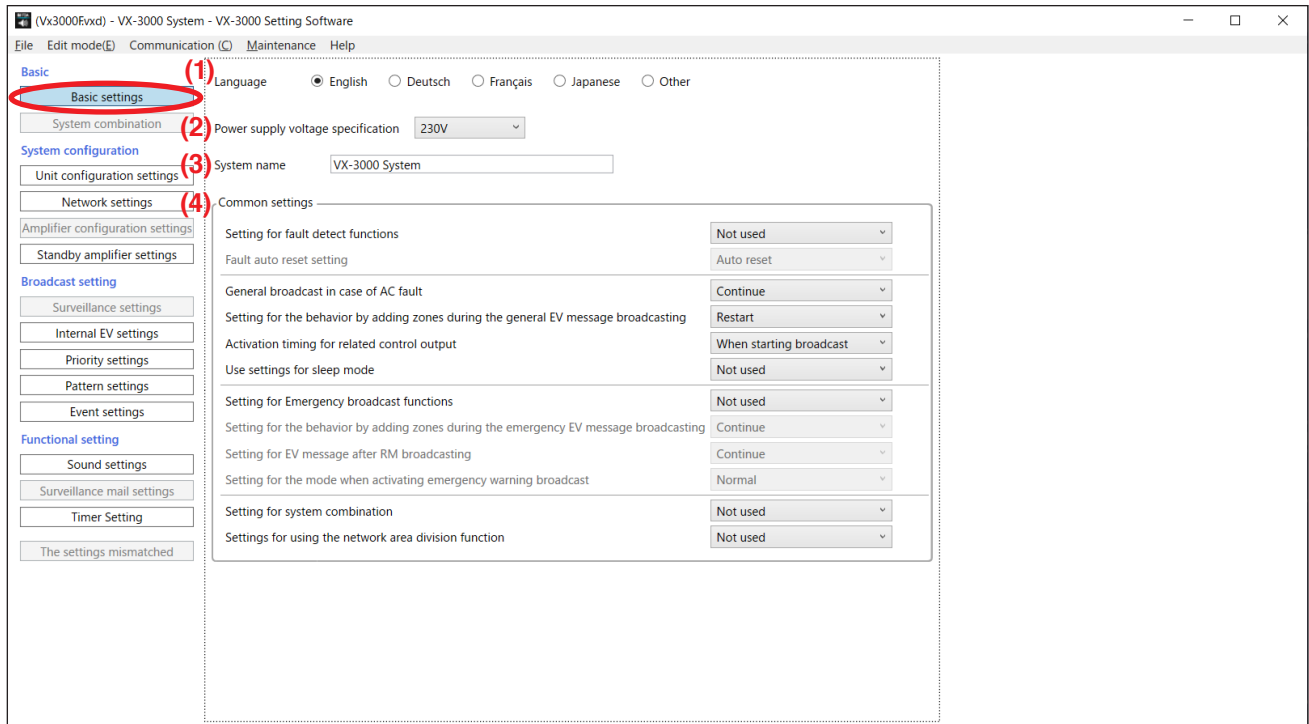

### (1) Language

Select the language to use.

Available Settings	English (default), Deutsch, Français, Japanese, Other
--------------------	---

#### Note

"Other" language can be set freely according to your needs.  
Contact your nearest TOA dealer regarding the setting method.

### (2) Power supply voltage specification

Select the power supply voltage specification.

Available Settings	230 V (default), 100 V
--------------------	------------------------

### (3) System name

Enter the system name.

Available Settings	Up to 32 alphanumeric characters*
--------------------	-----------------------------------

\* Following symbols can also be used.

! " # \$ % & ' ( ) = ~ | - ^ \ @ [ ; : ] , . / ` { + \* } > ? \_

### (4) Common settings

#### • Setting for fault detect functions

Set whether or not to use this function in each individual part of the VX-3000F, RM-200SF, and RM-300X.

Available Settings	Not used (default), Used
--------------------	--------------------------

#### • Fault auto reset setting (Only when "Setting for fault detect functions" is set to "Used")

Available Settings	Auto reset (default), Manual reset
--------------------	------------------------------------

Auto reset: Fault indication automatically disappears when fault is restored.

Manual reset: The fault indication remains on-screen and the buzzer sounding until the Fault reset key is pressed even when fault is restored.

• **General broadcast in case of AC fault**

Set whether or not general broadcasts will be continued when a power failure occurs.

Available Settings	Continue (default), Stop, Only BGM stop
--------------------	---

Continue: Continues all general broadcasts even during power failures.

Stop: Stops all general broadcasts during power failures.

Only BGM stop: Continues general broadcasts even during power failures, stopping only the broadcast of which type is set to "BGM."

• **Setting for the behavior by adding zones during the general EV message broadcasting**

Set the operation when the broadcast zone is added during the general EV message broadcast.

Available Settings	Restart (default), Continue
--------------------	-----------------------------

• **Activation timing for related control output**

Set the timing that enables the control output interlocked when the remote microphone's and the VX-3000CT's zone selection function is used.

Available Settings	When starting broadcast (default), When selecting zones
--------------------	---

When starting broadcast: The control output functions during broadcast.

The Interlock control output is activated at the timing when the broadcast is started through the talk key operation and terminated at the timing when the broadcast is ended through the talk key operation.

When selecting zones:

The control output functions during zone selection. The interlock control output is activated at the timing when zone is selected and terminated at the timing when zone selection is cleared.

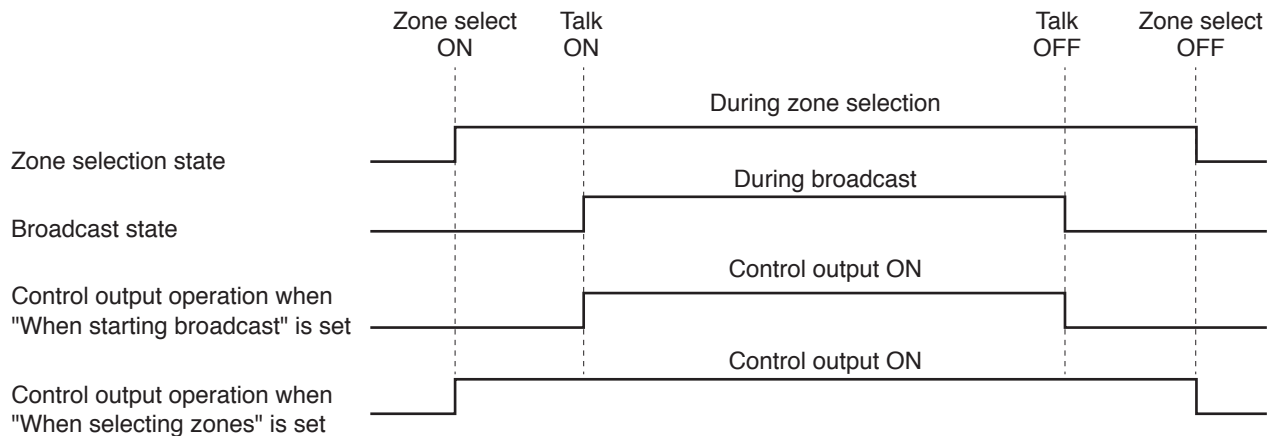

• **Use settings for sleep mode**

Set whether or not to use the sleep mode.

Using the sleep mode makes the amplifier not engaged in broadcasting turned off, stopping the built-in fan operation.

Available Settings	Not used (default), Used
--------------------	--------------------------

• **Setting for Emergency broadcast functions**

Set whether or not to use the Emergency broadcast function.

Available Settings	Not used (default), Used
--------------------	--------------------------

• **Setting for the behavior by adding zones during the emergency EV message broadcasting (only when the emergency broadcast function is set to "Used")**

Set the operation when the broadcast zone is added during the emergency EV message broadcast of which type is set to "Alert," "Evacuate," or "Restoration."

Available Settings	Continue (default), Restart
--------------------	-----------------------------

- **Setting for EV message after RM broadcasting (only when the emergency broadcast function is set to "Used")**

Set whether to enable or disable EV Message (broadcast of the message registered as sound source of the emergency broadcast) to the zones after the Emergency RM broadcast by microphone announcement is completed.

Available Settings	Continue (default), Stop
--------------------	--------------------------

- **Setting for the mode when activating emergency warning broadcast (only when the emergency broadcast function is set to "Used")**

Set whether to treat the emergency warning broadcast as general broadcast or to activate the emergency mode.

Available Settings	Normal (default), Emergency mode
--------------------	----------------------------------

Normal: Treats the emergency warning broadcast as general broadcast.

Emergency mode: Activates the emergency mode at the time of emergency warning broadcast start.

**Tip**

For the details, see [p. 3-12 "Emergency Warning Broadcast."](#)

- **Setting for system combination**

Up to 4 VX-3000 systems can be used as an integrated system by combining other VX-3000 systems together.

Broadcasts can be made to up to 2560 zones\* in total by combining 4 VX-3000 systems together.

\* When 40 VX-3016F units are used per system

Available Settings	Not used (default), Used
--------------------	--------------------------

**Note**

If set to "Used," the System combination button located on the upper left of the screen becomes active.

For the settings to be made on the screen displayed by clicking the System combination button, see the separate "System Combination Function Instruction Manual." Download the latest version from the TOA product data download site (<http://www.toa-products.com/international/>).

- **Setting for using the network area division function**

Set whether or not to use the network area division function.

Using this function enables the unicast audio transmission to other network areas through the VX-3000PM.

Available Settings	Not used (default), Used
--------------------	--------------------------

## 7. SYSTEM SETTINGS

### 7.1. Unit Configuration Settings

Clicking the Unit configuration settings button displays the screen below.

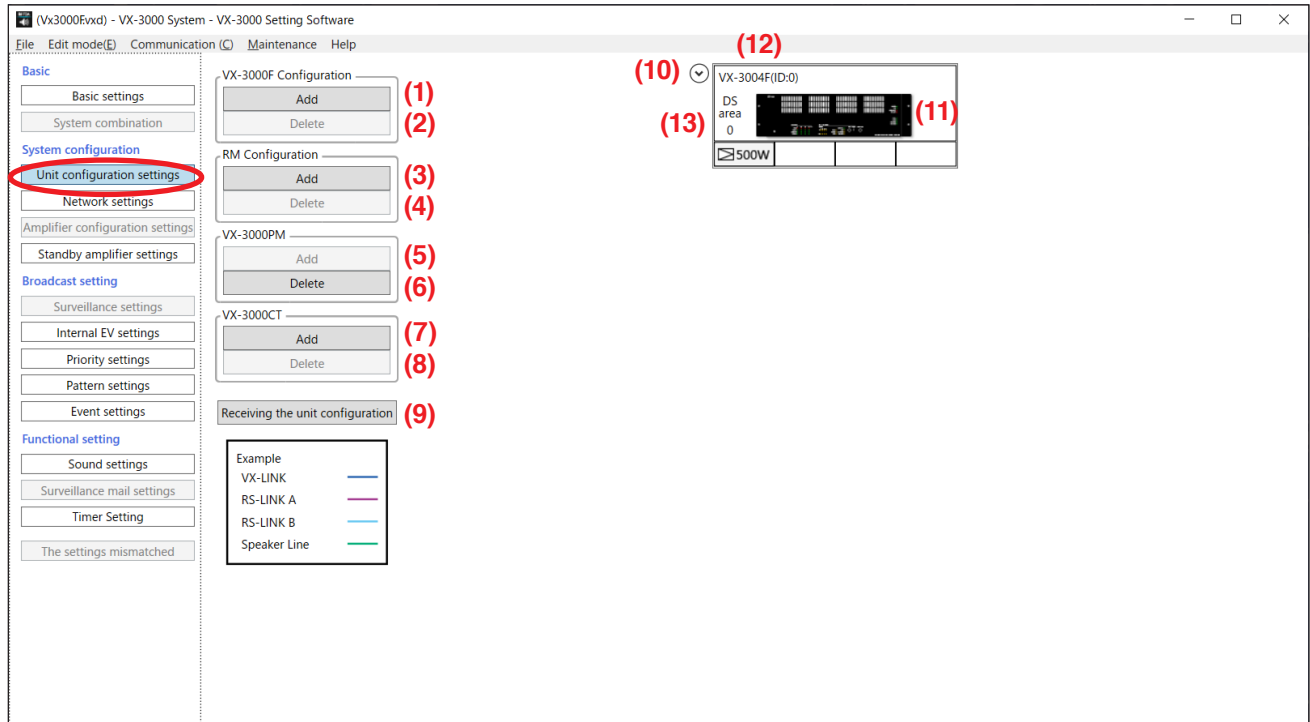

#### Note

The system configuration data can be acquired online if the equipment has already been installed. (See p. 3-51.)

- (1) VX-3000F Configuration: Add**  
Adds the VX-3000F to the unit configuration. (See p. 3-43.)
- (2) VX-3000F Configuration: Delete**  
Deletes the designated VX-3000F from the configuration. (See p. 3-47.)
- (3) RM Configuration: Add**  
Adds the remote microphone to the unit configuration. (See p. 3-48.)
- (4) RM Configuration: Delete**  
Deletes the designated remote microphone from the configuration. (See p. 3-48.)
- (5) VX-3000PM: Add**  
Adds the VX-3000PM to the unit configuration. (See p. 3-49.)
- (6) VX-3000PM: Delete**  
Deletes the designated VX-3000PM from the configuration. (See p. 3-49.)
- (7) VX-3000CT: Add**  
Adds the VX-3000CT to the unit configuration. (See p. 3-49.)
- (8) VX-3000CT: Delete**  
Deletes the designated VX-3000CT from the configuration. (See p. 3-50.)
- (9) Receiving the unit configuration**  
Detects the connected unit and acquires the unit configuration. (See p. 3-51.)
- (10) VX-3000F configuration detail display button**  
You can confirm the details of the unit connected to the VX-3000F. (See p. 3-46.)

**(11) Component icon**

Shows the unit registered as component.

**(12) VX-3000F's name**

Shows the name of the VX-3000F.

You can edit the unit name by clicking on it.

Up to 32 alphanumeric characters can be set.

**(13) DS area**

Shows area of the VX-3000DS used to judge if power has failed or not.

You can edit the area number by clicking on it.

Area number can be set in the range of 0 to 31.

## 7.2. Adding the VX-3000F to the Unit Configuration

Clicking the [VX-3000F Configuration: Add] button pops up the "Registration of VX-3000F units" window. Perform settings of the VX-3000F to be added to the unit configuration. Set contents are different for each model. Up to 40 units in total of 3 models can be used.

[When adding the VX-3004F]

[When adding the VX-3008F]

[When adding the VX-3016F]

Set the items below and click the OK button. Then, the unit designated in the Unit type (1) is added in the Unit configuration display on the Unit configuration settings screen by the number of units entered in the "Selected unit # Add set" (6).

### (1) Unit type

Select the model number.

If you change the model by clicking the radio button, the display of the set contents changes accordingly.

**(2) Extension setting (VX-3008F and VX-3016F only)**

Set the number of the VX-3008F or VX-3016F units to be additionally connected for the zone number extension.

Available Settings	0 – 3 (default: 0)
--------------------	--------------------

**Note**

For the VX-3016F, this item cannot be set when the Standby amplifier channel in the Amplifier setting (4) is set to "Used as normal amplifier."

**(3) Power Supply Setting****• DS**

Set whether or not to connect the VX-3000DS to DS Link connector.

Available Settings	Not used (default), Used
--------------------	--------------------------

**• Area**

Set area of the VX-3000DS used to judge if power has failed or not.

Available Settings	0 – 31 (default: 0)
--------------------	---------------------

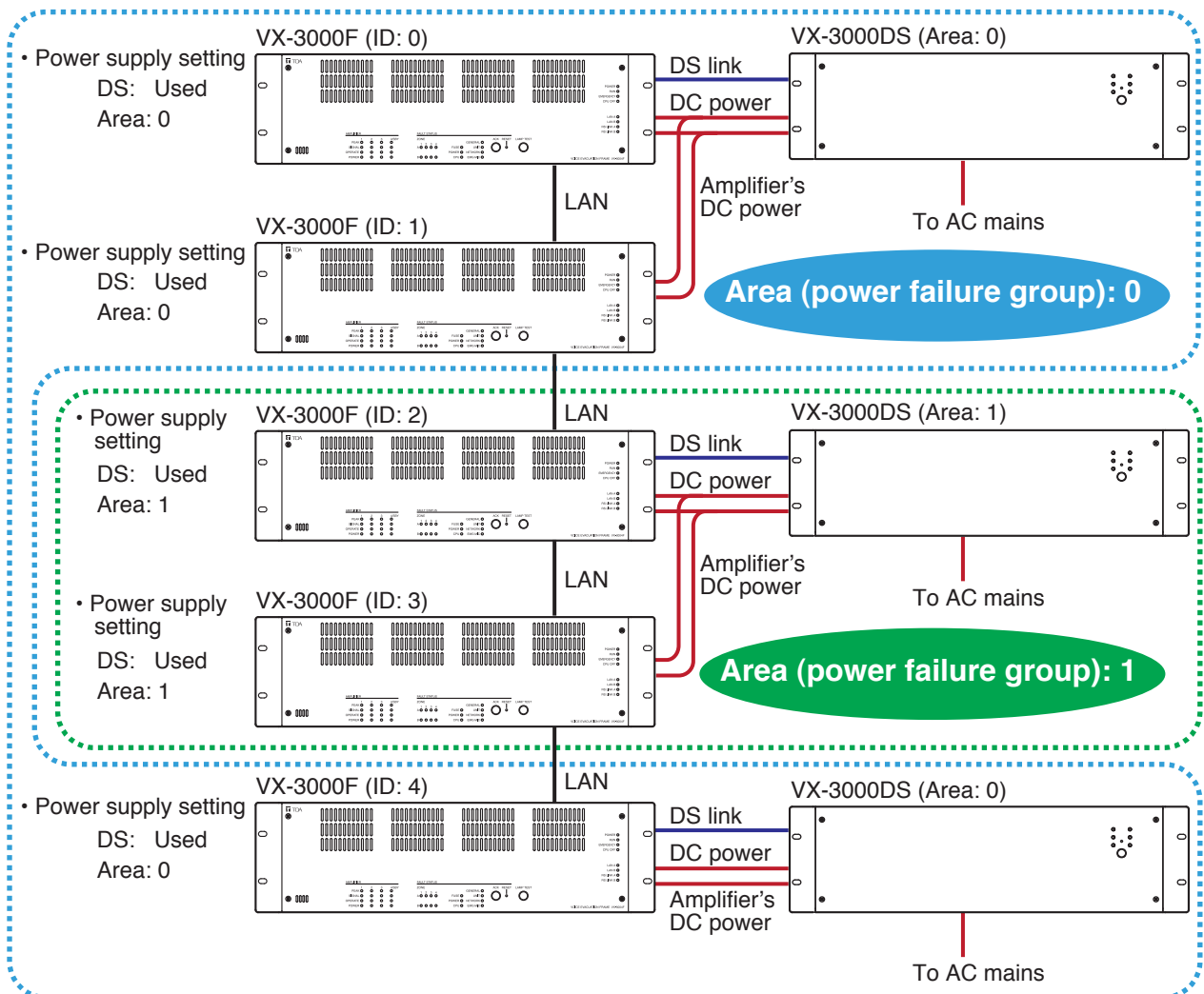
**[Area setting example]****Notes**

- You can also set 2 or more VX-3000DS units in one area.
- When AC power supply to one or more VX-3000DS units stops in an area, power of all the VX-3000F units within that area fails, and the units will be placed in power failure operation mode\*. For example, in the figure above, when AC power supply to the VX-3000DS connected to the VX-3000F (ID: 0) stops, power of the VX-3000F units (ID: 0, 1, 4) fails even if AC power is supplied to the VX-3000DS connected to the VX-3000F (ID: 4), and the VX-3000F units (ID: 0, 1, 4) will be placed in power

failure operation mode\*.

\* Emergency broadcast operation is switched to that on battery power. General broadcast will stop or its operation will be switched to that on battery power depending on the setting.

- Never connect the VX-3000DS's DC power output to the DC power input of the VX-3000F, VX-015DA, VX-030DA, or VX-050DA set for covering a different area.  
Even when "Stop" is selected for "General broadcast in case of AC fault" (p. 3-39), the battery connected to the VX-3000DS for the power failure area is consumed by the General broadcasts made for the non-power failure area.
- The VX-3000Fs' IDs within the same area need not be numbered consecutively.

#### (4) Amplifier setting

Perform settings of the built-in digital power amplifier module used for each channel and used as standby amplifier or the built-in line output module used for each channel.

The icon below appears for the amplifier set as standby amplifier.

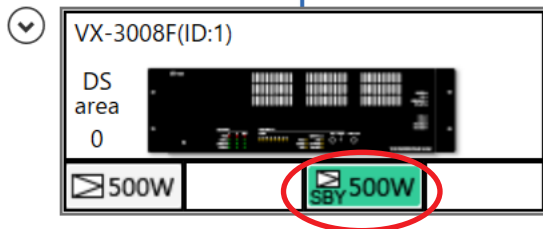

- **Use Ch4 as standby amplifier (VX-3004F only)**

Check the checkbox when using the digital power amplifier module installed in Ch4 as a standby amplifier.

- **Standby amplifier (VX-3008F only)**

Set whether or not to install a standby amplifier.

Available Settings	Not used (default), Used
--------------------	--------------------------

- **Standby amplifier channel (VX-3016F only)**

Sets use application of the digital power amplifier module to be installed in Ch2/Standby.

Available Settings	Not used (default), Used as standby amplifier, Used as normal amplifier
--------------------	---

- **Unit type**

Set the model number of the digital power amplifier module to be installed for each channel and standby amplifier or the line output module used for each channel.

##### [In the case of AMP 1]

Available Settings	[When "Power supply voltage specification" is set to "230 V"] Not used, VX-015DA, VX-030DA, VX-050DA (default), VX-300LO [When "Power supply voltage specification" is set to "100 V"] Not used, VX-012DA-2, VX-024DA-2, VX-036DA-2 (default), VX-300LO
--------------------	--

##### [In the case of slot other than AMP 1]

Available Settings	[When "Power supply voltage specification" is set to "230 V"] Not used (default), VX-015DA, VX-030DA, VX-050DA, VX-300LO* [When "Power supply voltage specification" is set to "100 V"] Not used (default), VX-012DA-2, VX-024DA-2, VX-036DA-2, VX-300LO*
--------------------	--

\* You cannot assign the VX-300LO to the channel used as standby amplifier.

- **SP line voltage (Only when "Unit type" is set to the digital amplifier module's model number)**

Set the speaker line voltage of the digital power amplifier module to be installed for each channel and standby amplifier.

Available Settings	100 V (default), 70 V, 50 V
--------------------	-----------------------------

#### (5) Network area (Only when "Settings for using the network area division function" is set to "Used")

Set the network area.

Available Settings	Network Area 0 – 7 (default: Network Area 0)
--------------------	--

**(6) Selected unit # Add set**

Set the number of the VX-3000F units to be added to the configuration with the above set contents.

Click the OK button after entering the number of the units. Then, the unit(s) are added in the equipment configuration field on the right side of the menu, and the "Registration of VX-3000F units" window will be closed.

Unit configuration detail display button

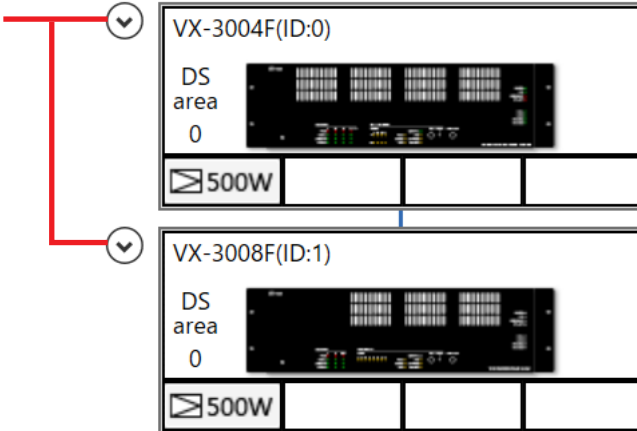
**• Unit configuration detail display button**

You can confirm the details of the unit configuration when you click the "v" button (unfold button) on the left side of the Unit icon.

Click the "∧" button (fold button) on the upper left to close the screen.

You can perform detailed settings by clicking each frame of the detail display in the same way when you click the component icon.

Frames corresponding to the setting screens are as follows.

Frame of power amplifier or model No./ID: VX configuration setting

Frame of audio input: Setting for audio input

Frame of speaker output: Setting for audio output

You can also perform detailed settings of the control input/output on the screen displayed by clicking the above each icon or frame.

SLOT	Unit type	SP line voltage
AMP1	VX-050DA	100V
AMP2	Not used	100V
AMP3	Not used	100V
AMP4/STANDBY	Not used	100V

Also, when you click the frame of the remote microphone displayed in black, the RM config screen for detailed settings of the remote microphone appears. (Even if you click the frame with gray characters, this operation is invalid because no remote microphone connection setting is made.)

RM setting		Name setting	
Name	VX0-RM0	-	Name
Unit type	RM-200SF	EMG	EMG
Extension switch number	0	SYS1	SYS1
Connected connector	RS-LINK A	SYS2	SYS2
		SYS3	SYS3
		TALK	TALK

### 7.3. Deleting the VX-3000F from the Unit Configuration

Clicking the [VX-3000F Configuration: Delete] button pops up the "Delete of VX-3000F units" window, which displays a list of the VX-3000F units included in the configuration.

VX-3004F(ID:0)  
 VX-3008F(ID:1)  
 VX-3016F(ID:2)

#### Note

The unit with ID "0" cannot be deleted.  
The VX-3000F set to ID "0" must be included in the unit configuration.

Check the checkbox for the VX-3000F to be deleted, then click the OK button. The unit will be deleted from the equipment configuration field, and the "Delete of VX-3000F units" window will be closed.

## 7.4. Adding the Remote Microphone to the RM Configuration

Clicking the [RM Configuration: Add] button pops up the "Registration of RM" window. Perform settings for the Remote microphone to be connected to the VX-3000F.

(1) Unit type:  RM-200SF  RM-300X

(2) Extension setting: Extension switch number: 0

(3) Setting the connection: Connected unit: VX-3004F(ID:0)

(4) Connected connector: RS-LINK A

(5) Selected unit: 1 Add sets

OK Cancel

### Note

If the system is required to comply with EN54-16, observe the following restrictions.

- Out of 8 connectable remote microphones, the number of the connectable RM-200SF units or RM-300X units for emergency broadcasts\* is up to 2 in total, and 1 to a single channel of RS link.
- When connecting the RM-200SF or the RM-300X for emergency use\* directly to each VX-3000F's RS link, make its distance shortest compared to other remote microphones.

\* The remote microphone should be the one of which type is set to "Emergency" or "Emergency/General" in the Talk key setting (p. 3-63) of the RM configuration setting.

### (1) Unit type

Select the model number of the remote microphone.

### (2) Extension switch number

Set the number of the extension units connected for extending the number of switches.

Available Settings	When "Unit type" is set to "RM-200SF": 0 (default) to 4 When "Unit type" is set to "RM-300X": 0 (default) to 7
--------------------	---

### (3) Connected unit

Designate the VX-3000F to which the target remote microphone is connected.

### (4) Connected connector

Designate the RS link terminal to which the target remote microphone is connected.

Available Settings	RS-LINK A (default), RS-LINK B
--------------------	--------------------------------

### (5) Selected unit # Add sets

Click the OK button after entering the number of the remote microphones. Then, the remote microphone(s) will be added to the VX-3000F designated in "Connected unit" (3), and the "Registration of RM" window will be closed.

## 7.5. Deleting the Remote Microphone from the RM Configuration

Clicking the [RM Configuration: Delete] button pops up the "Delete of RMs" window, which displays a list of the remote microphones included in the configuration.

Delete of RMs

VX-3004F(ID:0)

RM-200SF(ID:0)

RM-200SF(ID:1)

RM-200SF(ID:2)

RM-200SF(ID:3)

VX-3008F(ID:1)

RM-300X(ID:0)

RM-300X(ID:1)

OK Cancel

Check the checkbox for the remote microphone to be deleted, then click the OK button.

It will be deleted from the equipment configuration field, and the "Delete of RMs" window will be closed.

## 7.6. Adding the VX-3000PM to the Unit Configuration

Clicking the [VX-3000PM: Add] button pops up the "Registration of PM" window. Select the VX-3000F to connect in the "Connected unit," then click the OK button. The VX-3000PM will be added to the designated VX-3000F and the "Registration of PM" window will be closed.

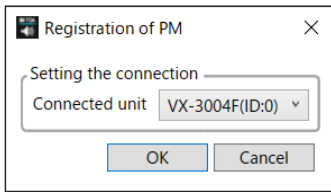

## 7.7. Deleting the VX-3000PM from the Unit Configuration

Clicking the [VX-3000PM: Delete] button pops up the "Delete of PMs" window. Check the checkbox for the VX-3000PM to be deleted, then click the OK button. The VX-3000PM will be deleted from the equipment configuration field, and the "Delete of PMs" window will be closed.

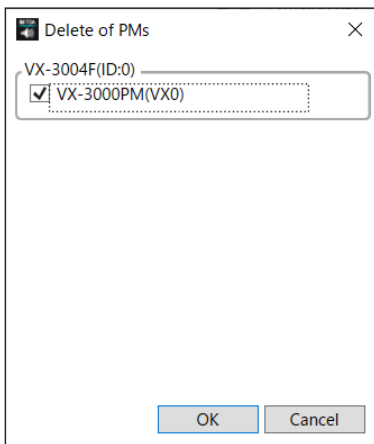

## 7.8. Adding the VX-3000CT to the Unit Configuration

Clicking the [VX-3000CT: Add] button pops up the "Registration of CT" window. Perform settings for the VX-3000CT to be connected to the VX-3000F.

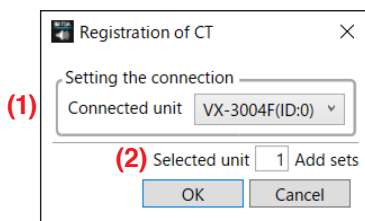

### (1) Connected unit

Designate the VX-3000F to which the VX-3000CT is connected.

### (2) Selected unit # Add set

Enter the number of the VX-3000CT units, then click the OK button. Up to 2 units can be added. The VX-3000CT will be added to the VX-3000F designated in "Connected unit" (1), and the "Registration of CT" window will be closed.

## 7.9. Deleting the VX-3000CT from the Unit Configuration

Clicking the [VX-3000CT: Delete] button pops up the "Delete of CTs" window.

Check the checkbox for the VX-3000CT to be deleted, then click the OK button.

The VX-3000CT will be deleted from the equipment configuration field, and the "Delete of CTs" window will be closed.

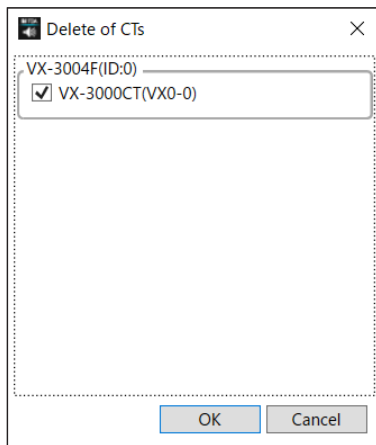

## 7.10. Receiving the Unit Configuration

You can detect the unit connected to a network and read the unit configuration data from the connected unit.

### Note

It is not possible to detect the device beyond the router.

**Step 1.** Click the [Receiving the unit configuration] button.

The "Receiving the unit configuration" window appears and the VX-3000F, VX-3000PM, and VX-3000CT units detected on the local network will be listed.

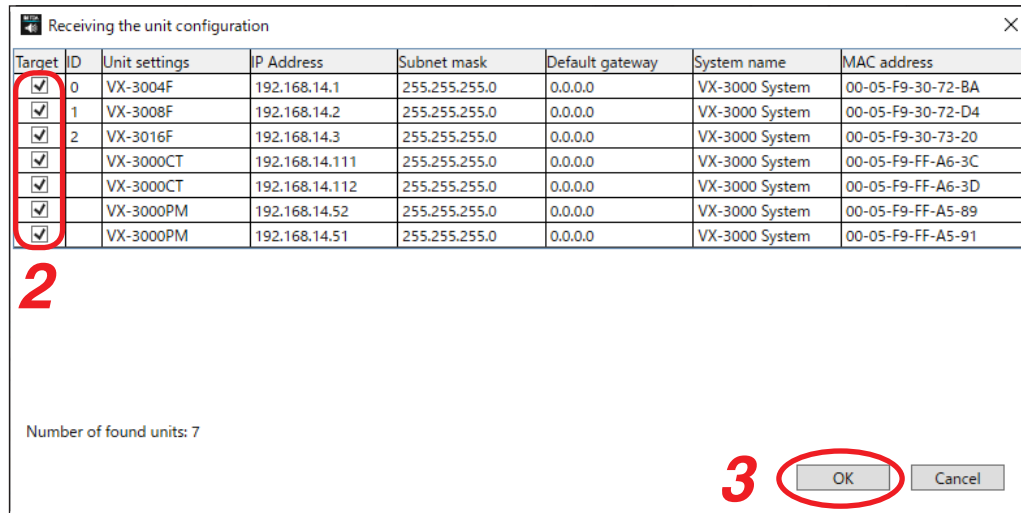

### Note

When multiple IP addresses are set in a PC, the source IP address (p. 3-205) selection screen is displayed before the unit detection is executed, then select the desired IP address.

**Step 2.** Check the checkboxes for the units of which unit configuration data you want to acquire.

### Note

When the IDs overlap, you can select only one of them.

**Step 3.** Click the OK button.

Reception starts.

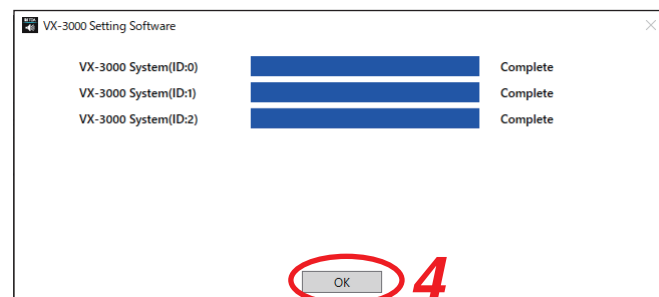
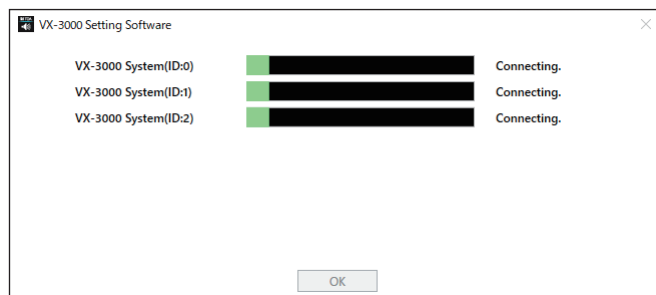

- Step 4.** Click the OK button after reception completion.  
Reception result is reflected in the unit configuration screen. When the extension unit has been set, its result is also reflected.

Then, a dialog below is displayed.

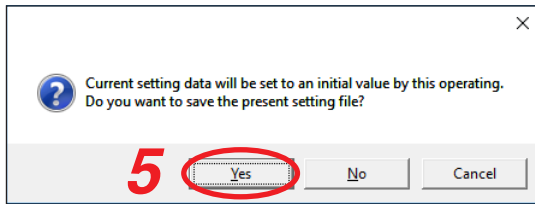

- Step 5.** Click the Yes button.  
The current settings are saved into the setting file as defaults.

### Notes

- When the VX-3008F or the VX-3016F both having no built-in digital amplifier module is detected, the dialog shown below will appear.  
Set the extension unit following the procedures below.

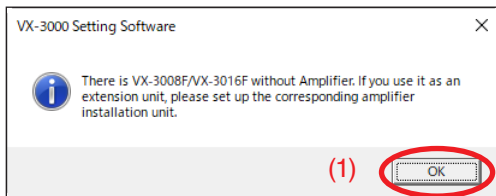

- (1) Click the OK button.  
The dialog below appears.

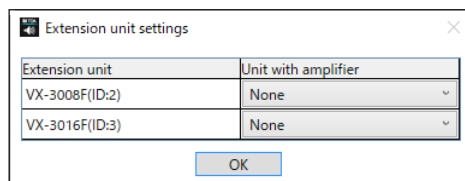

- (2) When using the detected unit with no amplifier as an extension unit, select the unit with amplifier.

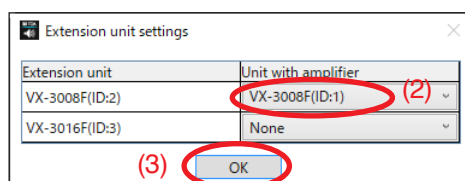

### Note

The unit with amplifier can be selected only from those of the same model as the units with no amplifier.

- (3) Click the OK button.

- When the VX-3000PM is detected, the dialog shown below will appear. Perform the setting following the procedures below.

**Note**

The number of the VX-3000PM units which can be connected is 1 per VX-3000F.

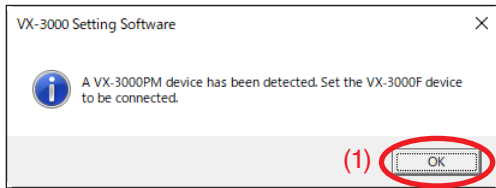

- Click the OK button.

The dialog below appears.

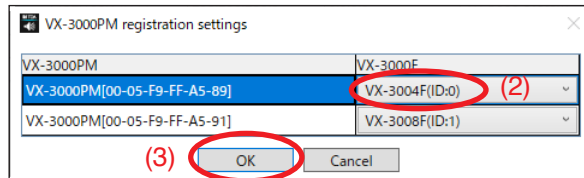

- Select the VX-3000F to which the VX-3000PM is connected.

- Click the OK button.

- When the VX-3000CT is detected, the dialog shown below will appear. Perform the setting following the procedures below.

**Note**

The number of the VX-3000PM units which can be connected is 2 per VX-3000F.

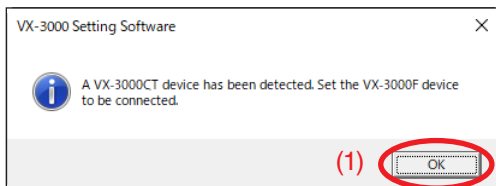

- Click the OK button.

The dialog below appears.

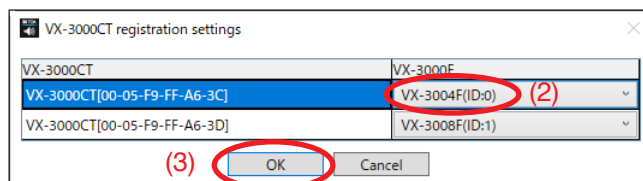

- Select the VX-3000F to which the VX-3000CT is connected.

- Click the OK button.

## 7.11. Setting the VX-3000F's Unit Configuration

Clicking the unit icon in the unit configuration display pops up the setting window for each unit.

The screenshot shows a configuration window titled "VX-3004F(ID:0)". It has four tabs: "VX configuration setting" (selected), "Settings for audio input", "Settings for audio output", and "Settings for terminals".

Under "VX configuration setting", there are several sections:

- Unit type:** Radio buttons for VX-3004F (selected), VX-3008F, and VX-3016F.
- Power Supply Setting:** DS dropdown set to "Not used" and Area dropdown set to "0".
- Amplifier setting:** A checkbox "Use Ch4 as standby amplifier" is unchecked.
- Table:** A table with columns SLOT, Unit type, and SP line voltage.
 

SLOT	Unit type	SP line voltage
AMP1	VX-050DA	100V
AMP2	Not used	100V
AMP3	Not used	100V
AMP4/STANDBY	Not used	100V
- Network area:** A dropdown menu set to "NetworkArea 0".

At the bottom right, there are "OK" and "Cancel" buttons.

### 7.11.1. VX configuration setting

Clicking the VX configuration setting tab displays the window as shown below.

Perform the basic configuration setting of the VX-3000F in the same way as the unit configuration add setting. (See p. 3-43.)

This screenshot is identical to the one above, showing the "VX configuration setting" tab of the "VX-3004F(ID:0)" window. It details the unit type, power supply settings, amplifier settings, a table of amplifier slots, and network area settings.

### 7.11.2. Audio input setting

Clicking the Settings for audio input tab displays the window as shown below.  
Perform the settings such as audio input names and input signal levels.

	Name	Purpose	Phantom power	Input Mix	Type	Mixing setting	Fade out	Fade in	Attenuation
AUDIO IN1	Analog 0-1	MIC	On	AUDIO IN1	BGM	MIXING			
AUDIO IN2	Analog 0-2	LINE		AUDIO IN2	General	MIXING			
AUDIO IN3	Analog 0-3	LINE		AUDIO IN3	General	MIXING			
AUDIO IN4	Analog 0-4	LINE		AUDIO IN4	General	MIXING			

(1)
(2)
(3)
(4)
(5)
(6)
(7)
(8)
(9)

#### (1) Name

Enter each name of the input channels.

Available Settings	Up to 32 alphanumeric characters (Default name: for example, Analog 0-1 represents the input channel No. 1 of the VX-3000F of ID No. 0.)
--------------------	--

#### (2) Purpose

Set the purpose of use such as audio signal's input level.

Available Settings	LINE (default), MIC, ANC # (LINE), ANC # (MIC)
--------------------	--

#### Notes

- When setting the ANC for the channel where the VOX function is in use, the VOX function is set to OFF.
- The ANC setting applies to the multiple Audio outputs within the unit set on the "Settings for audio output" tab.  
ANC setting cannot be made for other units.
- When Purpose is set to "ANC # (LINE)" or "ANC # (MIC)," each item of "Input Mix," "Type," "Mixing setting," "Fade out," "Fade in," and "Attenuation" cannot be set.

#### (3) Phantom power (Only when "Purpose" is set to "MIC" or "ANC # MIC")

Set ON or OFF of the phantom power.

Available Settings	Off (default), On
--------------------	-------------------

#### (4) Input Mix (Except when Purpose is set to "ANC # (LINE)" or "ANC # (MIC)")

Set whether to mix 2 or more audio inputs of a single VX-3000F to treat as a single sound source.

Audio inputs to which the same input mix numbers are designated are mixed.

Input Mixes are assigned to the AUDIO INs 1 through 4 by default so as to treat each audio input individually.

Available Settings	AUDIO IN 1, AUDIO IN 2, AUDIO IN 3, AUDIO IN 4
--------------------	--

#### (5) Type (Except when Purpose is set to "ANC # (LINE)" or "ANC # (MIC)")

Select the type of broadcast.

Available Settings	General (default), BGM, Emergency warning
--------------------	---

**(6) Mixing setting (Except when Purpose is set to "ANC # (LINE)" or "ANC # (MIC)")**

This function is used for mixing settings for BGM and general broadcasts.

**Note**

When broadcasts are output to the zones of the VX-3008F or VX-3016F, either one of the broadcast sound sources is output regardless of the mixing setting. BGM/General mixed broadcasts are disabled.

- **When "Type" is set to "General"**

Available Settings	MIXING* <sup>1</sup> (default), BGM CUT* <sup>2</sup>
--------------------	---

\*<sup>1</sup> Mixes General and BGM broadcasts.

\*<sup>2</sup> Cuts off BGM play in all general broadcast zones, regardless of the BGM side settings.

- **When "Type" is set to "BGM"**

Set mixing status when the general broadcast MIXING setting is set to MIXING.

Available Settings	REDUCTION* <sup>3</sup> , MIXING* <sup>4</sup> (default)
--------------------	--

\*<sup>3</sup> BGM play in general broadcast zones fades out to the preprogrammed attenuation and time, and both the general broadcast and BGM output are mixed.

\*<sup>4</sup> General broadcast and BGM output are mixed. The BGM volume does not vary during general broadcast.

- **When "Type" is set to "Emergency warning"**

Available Settings	BGM CUT (default)* <sup>5</sup> , MIXING* <sup>6</sup>
--------------------	--

\*<sup>5</sup> Cuts off BGM play in all Emergency warning broadcast zones, regardless of the BGM side settings.

\*<sup>6</sup> Mixes Emergency warning and BGM broadcasts.

**[Mixing setting combinations (Only when making broadcasts to the Zones allocated to the VX-3004F)]**

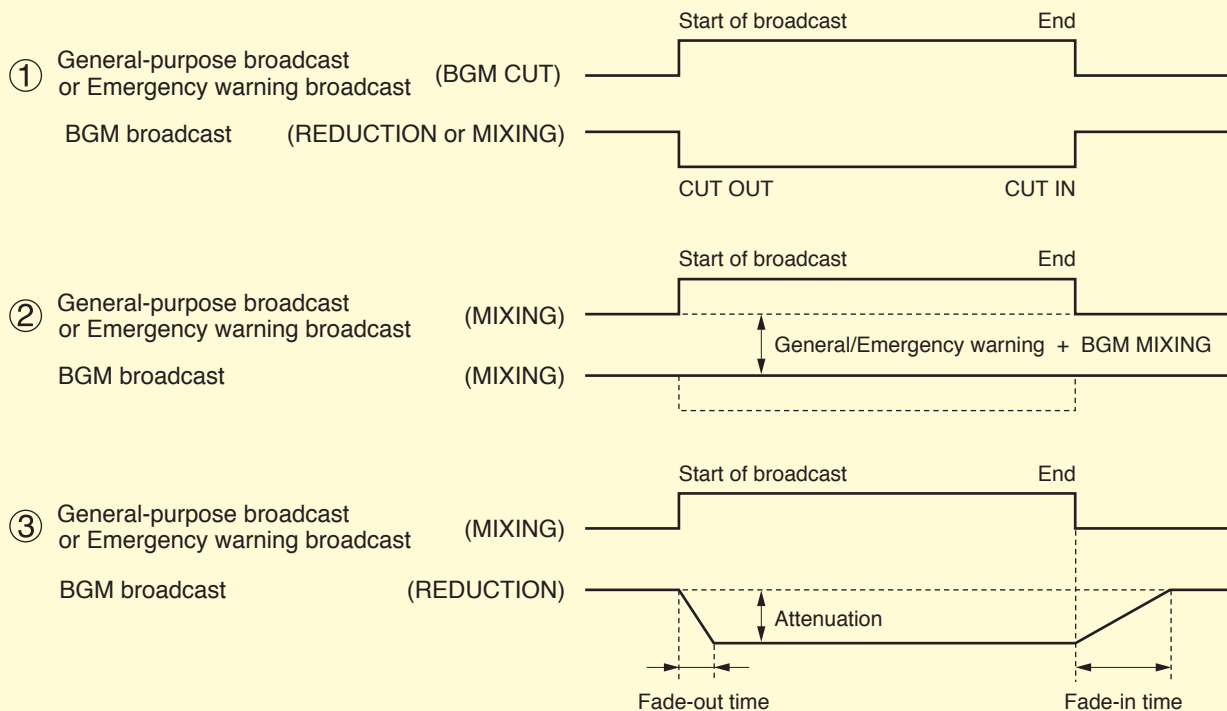
**(7) Fade out (Except when Purpose is set to "ANC # (LINE)" or "ANC # (MIC)")**

This selection becomes available when "Mixing setting" is set to "REDUCTION."

Available Settings	0, 0.1, 0.2, 0.5, 1, 2, 3, 4, 5, 6, 7, 8, 9, 10 [sec] (default: 1)
--------------------	--

**(8) Fade in (Except when Purpose is set to "ANC # (LINE)" or "ANC # (MIC)")**

This selection becomes available when "Mixing setting" is set to "REDUCTION."

Available Settings	0, 0.1, 0.2, 0.5, 1, 2, 3, 4, 5, 6, 7, 8, 9, 10 [sec] (default: 4)
--------------------	--

**(9) Attenuation (Except when Purpose is set to "ANC # (LINE)" or "ANC # (MIC)")**

This selection becomes available when "Mixing setting" is set to "REDUCTION."

Available Settings	-40 [dB] to -1 [dB], -∞ [dB] (default: -40), in 1-dB steps
--------------------	--

**7.11.3. Audio output setting**

Clicking the Settings for audio output tab displays the window as shown below.

Set the zone output name and whether or not to use zone output, attenuator, related control output\*, EOL, and ANC sensor.

The number of zones to set differs depending on the model.

VX-3004F: 4 zones

VX-3008F: 8 zones

VX-3016F: 16 zones

\* VX-3004F and VX-3008F only

	Name	Zone setting	ATT setting	Related control output	EOL setting	ANC Sensor
Zone1	ZONE 0-1	AB zone use	Not used	Not used	Not used	None
Zone2	ZONE 0-2	AB zone use	Not used	Not used	Not used	None
Zone3	ZONE 0-3	AB zone use	Not used	Not used	Not used	None
Zone4	ZONE 0-4	AB zone use	Not used	Not used	Not used	None

(1) (2) (3) (4) (5) (6)

**(1) Name**

Enter each name of the output channels.

Available Settings	Up to 32 alphanumeric characters (Default name: for example, ZONE 0-1 represents the Zone 1 output of the VX-3000F of ID No. 0.)
--------------------	--

**(2) Zone setting**

Select whether or not to use each zone output.

- When "Unit type" is set to the digital amplifier module in the "Amplifier setting"

Available Settings	[When "Unit type" is set to "VX-3004F"] Not used, Use only the A zone, AB zone use (default) [When "Unit type" is set to "VX-3008F" or "VX-3016F"] Not used, Used (default)
--------------------	--

• When "Unit type" is set to the line output module in the "Amplifier setting"

Available Settings	[When "Unit type" is set to "VX-3004F"] Not used, Use only the A zone (default) [When "Unit type" is set to "VX-3008F" or "VX-3016F"] Not used, Used (default)
--------------------	---

### (3) ATT setting

Select whether or not to use attenuator(s).

Available Settings	Not used (default), Used
--------------------	--------------------------

#### Note

When "Unit type" is set to the line output module in the "Amplifier setting," you cannot use this setting. However, selecting "Used" in the "Interlock control output" (4) allows you to perform this setting.

### (4) Related control output (VX-3004F and VX-3008F only)

Set whether or not to use the function that turns on the control output while the audio is being distributed to the output zones.

When the system is so configured that an external amplifier is connected to the VX-3004F or the VX-3008F, the line connected to the external amplifier can be controlled using this function.

Available Settings	Not used (default), Used
--------------------	--------------------------

#### Note

When wishing to use the zone output linked to the VX-300LO connected to the VX-3008F, be sure to select "Used" for the interlock control output of the corresponding zone.

### (5) EOL setting

Set this item when the EOL (End-of-Line) unit is used.

This must be made valid in the speaker line failure detection settings.

Available Settings	Not used (default), Used
--------------------	--------------------------

#### Notes

- When "Unit type" is set to the line output module in the "Amplifier setting," you cannot use this setting.
- Even when using the EOL units, it is necessary to measure the speaker line impedance. Perform this measurement on the maintenance screen. (See p. 3-192 "Initializing the Speaker Line Impedance.")
- For the VX-3008F and VX-3016F, when EOL is set to "Used," the Control input with the same number as the zone number functions as an EOL input. Any other function cannot be assigned to the Control input.

When an emergency broadcast is set to "Used," the ATT/Control output of the channel that is the same as the number of zone\* for which "ATT" is set to "Used" is activated in emergency broadcast state. Use this ATT/Control output to bypass the external attenuators in the emergency state. See the separate Installation Manual, "Speaker connection."

\* For the VX-3004F, SP OUT 1A corresponds to ATT/Control out 1 and SP OUT 1B to ATT/Control out 2, and so on.

When "ATT" or "EOL" is set to "Used," the unit configuration is displayed on the screen as shown below.

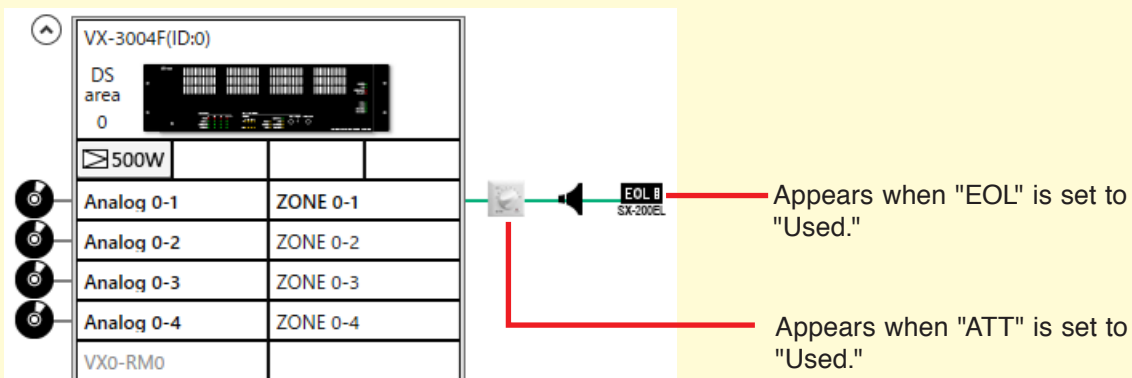

**(6) ANC Sensor**

Set the ANC Sensor corresponding to each zone.

This setting can be performed only when Purpose is set to "ANC # (LINE)" or "ANC # (MIC)" on the "Settings for audio input" tab.

Available Settings	None, ANC 1, ANC 2, ANC 3, ANC 4
--------------------	----------------------------------

**Notes**

- When the VX-3016F is placed in 2 channel mode, the following settings are selectable.  
Zone 1 – 8: None or ANC 1 can be selected.  
Zone 9 – 16: None, ANC 1, or ANC 2 can be selected.
- When the VX-3008F or VX-3016F is placed in 1 channel mode or set as an Extension unit, "ANC 1" indication is fixed to all zones.
- When "Unit type" is set to line output module in the "Amplifier setting," you cannot use this setting. However, selecting "Used" in the "Interlock control output" (4) allows you to perform this setting.

### 7.11.4. Terminal setting

Clicking the Settings for terminals tab displays the screen as shown below.

Set the VX-3000F's control input/output terminals.

Set the control input/output name and a control method of the control output.

The number of the control inputs is fixed to "18" for all models.

The number of the control outputs is as follows depending on the models.

VX-3004F/3008F: 16 (Terminal Nos. 1 through 8 function as the ATT control outputs.)

VX-3016F: 24 (Terminal Nos. 1 through 16 function as the ATT control outputs.)

VX-3004F(ID:0)

VX configuration setting Settings for audio input Settings for audio output Settings for terminals

(1) Control input setting

-	Name	
1	CIN 0-1	
2	CIN 0-2	
3	CIN 0-3	
4	CIN 0-4	
5	CIN 0-5	
6	CIN 0-6	
7	CIN 0-7	
8	CIN 0-8	
9	CIN 0-9	
10	CIN 0-10	
11	CIN 0-11	
12	CIN 0-12	
13	CIN 0-13	
14	CIN 0-14	
15	CIN 0-15	
16	CIN 0-16	
17	CIN 0-17	
18	CIN 0-18	

(2) Emergency control input setting

-	Name	
17	EMG CIN0-17	
18	EMG CIN0-18	

(3) Control output setting

-	Name	Output method	output time
1	ATT/COU0-1	Level	
2	ATT/COU0-2	Level	
3	ATT/COU0-3	Level	
4	ATT/COU0-4	Level	
5	ATT/COU0-5	Level	
6	ATT/COU0-6	Level	
7	ATT/COU0-7	Level	
8	ATT/COU0-8	Level	
9	COU0-9	Level	
10	COU0-10	Level	
11	COU0-11	Level	
12	COU0-12	Level	
13	COU0-13	Level	
14	COU0-14	Level	

OK Cancel

#### (1) Control input setting

- **Name**

Enter each name of the control inputs.

Available Settings	Up to 32 alphanumeric characters (Default name: for example, CIN 0-1 represents Pin 1 of the control input terminal 1 of the VX-3000F of ID No. 0.)
--------------------	---

#### (2) Emergency control input setting

- **Name**

Enter each name of the emergency control inputs.

Available Settings	Up to 32 alphanumeric characters (Default name: for example, EMG CIN 0-17 represents Pins 1 and 2 of the emergency control input terminal of the VX-3000F of ID No. 0.)
--------------------	---

#### (3) Control output setting

- **Name**

Enter each name of the control outputs.

Available Settings	Up to 32 alphanumeric characters (Default name: for example, ATT/COU0-1 represents the control output terminal 1 of the VX-3000F of ID No. 0.)
--------------------	--

- **Output method**

Set the output control method of the control output.

**Notes**

- Setting cannot be performed when the "Attenuator setting" corresponding to the zone output is set to "Used."
- Setting cannot be performed when the "Interlock control output setting" corresponding to the zone output is set to "Used."

Available Settings	Level (default), Pulse
--------------------	------------------------

- **Output time**

When "Pulse" is selected for the output control method of the control output, set the pulse width.

Available Settings	1 [sec] to 60 [sec] (default: 1), in 1-sec steps
--------------------	--

## 7.12. Setting the Remote Microphone Configuration

Clicking the remote microphone icon in the unit configuration detail display of the VX-3000F pops up the remote microphone configuration setting window.

RM-200SF(ID:0)

RM configuration setting TALK AUX

RM setting

Name: VX0-RM0

Unit type: RM-200SF

Extension switch number: 1

Connected connector: RS-LINK A

Name setting RS-LINK A(ID:0)

	Name
-	EMG
EMG	EMG
SYS1	SYS1
SYS2	SYS2
SYS3	SYS3
TALK	TALK
1	KEY1
2	KEY2
3	KEY3
4	KEY4
5	KEY5
6	KEY6
7	KEY7
8	KEY8
9	KEY9
10	KEY10
11	KEY11
12	KEY12

OK Cancel

### 7.12.1. RM configuration setting

Clicking the RM configuration setting tab displays the screen as shown below.

#### (1) RM configuration setting

- **Name**

Enter a name of the RM-200SF or RM-300X.

Available Settings	Up to 32 alphanumeric characters (Default name: for example, VX0-RM0 represents the RM-200SF or RM-300X of ID No. 0 connected to the VX-3000F of ID No. 0.)
--------------------	---

- **Unit type**

Select the model number of the remote microphone.

Available Settings	RM-200SF, RM-300X
--------------------	-------------------

- **Extension switch number**

Set the number of the extension units connected for extending the number of switches.

Available Settings	When "Unit type" is set to "RM-200SF": 0 (default) to 4 When "Unit type" is set to "RM-300X": 0 (default) to 7
--------------------	---

- **Connected connector**

Designate the RS link terminal to which the target remote microphone is connected.

Available Settings	RS-LINK A (default) , RS-LINK B
--------------------	---------------------------------

**(2) Name**

Enter each name of the emergency key and function keys on the RM-200SF's or RM-320F's front panel, or on the RM-300X's or RM-210F's top panel.

Available Settings	Up to 32 alphanumeric characters
--------------------	----------------------------------

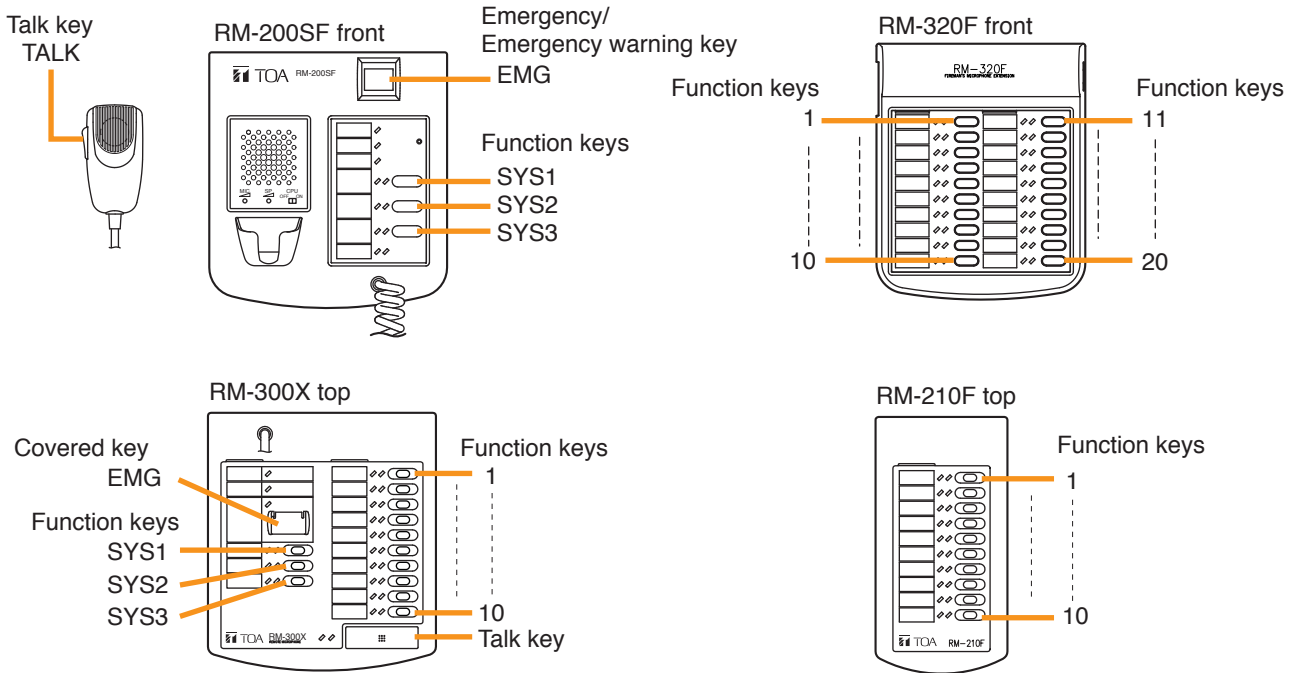

**7.12.2. TALK key setting**

Clicking the TALK tab displays the screen as shown below.

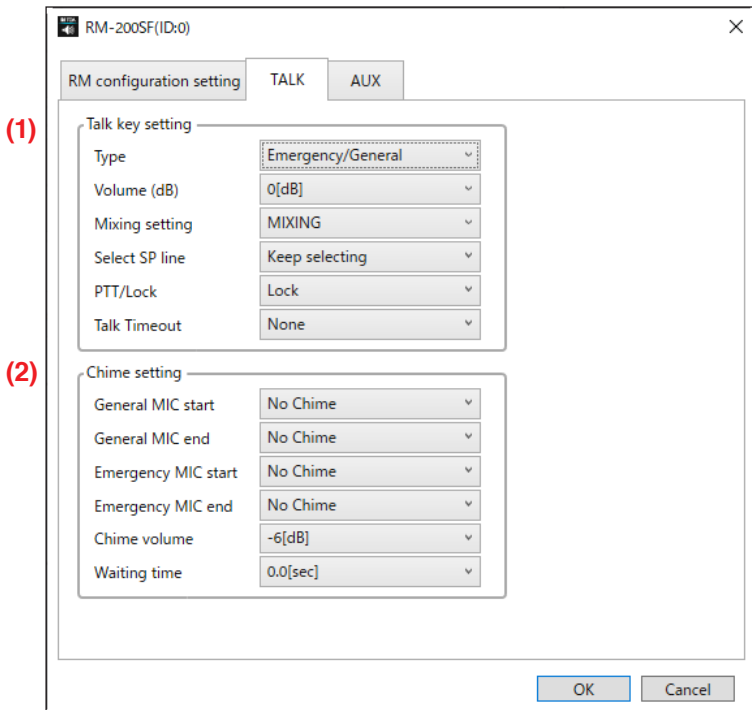

**(1) TALK setting**

• **Type**

Select the type of broadcast.

Available Settings	General (default), Emergency, Emergency/General
--------------------	---

- **Volume (dB)**

Select the volume of the announcement by remote microphone.

Available Settings	0 [dB] to -69 [dB] (in 1-dB steps), -∞ [dB] (default: 0 [dB])
--------------------	---

- **Mixing**

This function is used for mixing settings for general broadcasts.

Mixing status can be selected when "Type" is set to "General" or "Emergency/General."

When the "Type" is set to "Emergency," this function is fixed to "MIXING."

**Note**

When broadcasts are output to the zones allocated to the VX-3008F and VX-3016F, they are treated as "BGM CUT" regardless of the mixing setting without being mixed.

Available Settings	MIXING*1 (default), BGM CUT*2
--------------------	-------------------------------

\*1 Mixes General and BGM broadcasts.

\*2 Cuts off BGM play in all general broadcast zones, regardless of the BGM side settings.

- **Select SP line**

Select whether to maintain or cancel the selected state after microphone broadcast completion.

Available Settings	Keep selecting (default), Clear the select
--------------------	--

- **PTT/Lock**

When the "Unit type" is set to "RM-200SF," talk key operation method is fixed to "PTT."

When the "Unit type" is set to "RM-300X," select the operation method of talk key.

Available Settings	PTT (default) , Lock
--------------------	----------------------

**[PTT and Lock]**

Two different methods are available for talk key operation: Press-to-Talk (PTT) and Lock modes.

PTT: Enables microphone announcements to be made while the talk key is being pressed.

Lock: Enables microphone announcements by pressing the talk key once and terminates by pressing it again.

- **Talk Timeout**

The time-out period can be set when the "Talk" key operation method has been set to "Lock" mode. Select an appropriate time-out period after which remote microphone announcements are automatically terminated if the user fails to turn off the microphone power.

Available Settings	None (default) , 1 [min] to 20 [min]
--------------------	--------------------------------------

## (2) Chime setting

**Tips**

- The system chime is set as follows.  
Chime 1: ascending 4-note tone, Chime 2: descending 4-note tone, Chime 3: 2-tone chime, Chime 4: gong
- You can also use the chime sound source registered in the Internal EV setting (p. 3-87).

- **General MIC start**

Select the chime tone at the start of general microphone announcement.

Available Settings	No chime (default), Chime 1, Chime 2, Chime 3, Chime 4, Set chime sound source names
--------------------	--

- **General MIC end**

Select the chime tone at the end of general microphone announcement.

Available Settings	No chime (default), Chime 1, Chime 2, Chime 3, Chime 4, Set chime sound source names
--------------------	--

- **Emergency MIC start**

Select the chime tone at the start of emergency microphone announcement.

Available Settings	No chime (default), Chime 1, Chime 2, Chime 3, Chime 4, Set chime sound source names
--------------------	--

- **Emergency MIC end**

Select the chime tone at the end of emergency microphone announcement.

Available Settings	No chime (default), Chime 1, Chime 2, Chime 3, Chime 4, Set chime sound source names
--------------------	--

- **Chime volume**

Select the volume of the chime broadcast by the remote microphone.

Available Settings	0 [dB] to -20[dB] (in 1-dB steps) (default: 0 [dB])
--------------------	---

**Note**

When the chime sound source registered in the Internal EV setting (p. 3-87) is used, it is output with the volume level given by the sum of this set chime volume and the volume set for each audio data in the Internal EV setting.

- **Waiting time**

Set the time required to start broadcast\* after the talk key on the remote microphone has been pressed. Select the time according to the start-up time of connected external power amplifiers.

\* When "No chime" is selected for the start of remote microphone announcement, wait time means time duration before the microphone announcement starts, while when a system chime other than "No chime" is selected, it means the time duration before the chime sounds.

Available Settings	0, 0.5, 1, 1.5, 2, 3, 4 [sec] (default: 0)
--------------------	--

### 7.12.3. AUX setting

Clicking the AUX tab displays the screen as shown below.  
This setting is available when RM-300X is selected for unit type.

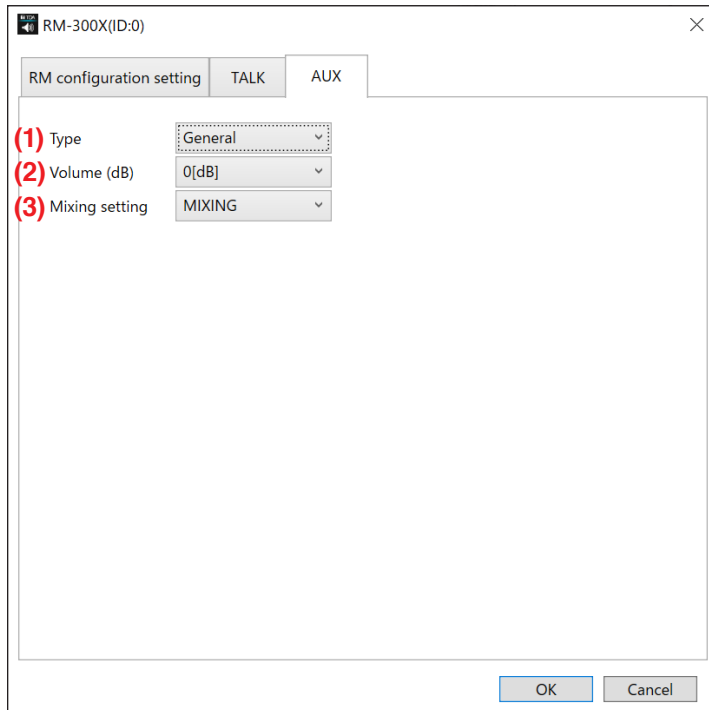

#### (1) Type

Select the type of broadcast.

Available Settings	General (default), BGM
--------------------	------------------------

#### (2) Volume (dB)

Select the volume of the broadcast by remote microphone's AUX input.

Available Settings	0 [dB] to -69 [dB] (in 1-dB steps), -∞ [dB] (default: 0 [dB])
--------------------	---

#### (3) Mixing setting

This function is used for mixing settings for BGM and general broadcasts.

##### • When "Type" is set to "General"

Available Settings	MIXING*1 (default), BGM CUT*2
--------------------	-------------------------------

\*1 Mixes general and BGM broadcasts.

\*2 Cuts off BGM play in all general broadcast zones, regardless of the BGM side settings.

##### • When "Type" is set to "BGM"

Available Settings	REDUCTION*3, MIXING*4 (default)
--------------------	---------------------------------

\*3 BGM play in general broadcast zones fades out to the preprogrammed attenuation and time, and both the general broadcast and BGM output are mixed.

\*4 General broadcast and BGM output are mixed. The BGM volume does not vary during general broadcast.

## 7.13. Setting the VX-3000PM's Configuration

Clicking the VX-3000PM icon in the VX-3000F unit configuration display pops up the setting window for VX-3000PM unit.

### 7.13.1. Audio input setting

Clicking the Settings for audio input tab displays the window as shown below. Perform the settings such as audio input names and type of broadcast.

	Name	Input Mix	Type	Mixing setting	Fade out	Fade in	Attenuation	Broadcast between networks
1	VX0-PM-Analog 1	AUDIO IN1	General	MIXING				Not used
2	VX0-PM-Analog 2	AUDIO IN2	General	MIXING				Not used
3	VX0-PM-Analog 3	AUDIO IN3	General	MIXING				Not used
4	VX0-PM-Analog 4	AUDIO IN4	General	MIXING				Not used
5	VX0-PM-Analog 5	AUDIO IN5	General	MIXING				Not used
6	VX0-PM-Analog 6	AUDIO IN6	General	MIXING				Not used
7	VX0-PM-Analog 7	AUDIO IN7	General	MIXING				Not used
8	VX0-PM-Analog 8	AUDIO IN8	General	MIXING				Not used

(1) (2) (3) (4) (5) (6) (7) (8)

OK Cancel

#### (1) Name

Enter each name of the input channels.

Available Settings	Up to 32 alphanumeric characters (Default name: for example, VX0-PM-Analog 1 represents the input channel No. 1 of the VX-3000PM connected to the VX-3000F of ID No. 0.)
--------------------	--

#### (2) Input Mix

Set whether to mix 2 or more audio inputs of a single VX-3000PM to treat as a single sound source.

Audio inputs to which the same input mix numbers are designated are mixed.

Input Mixes are assigned to the AUDIO INs 1 through 8 by default so as to treat each audio input individually.

Available Settings	AUDIO IN 1, AUDIO IN 2, AUDIO IN 3, AUDIO IN 4, AUDIO IN 5, AUDIO IN 6, AUDIO IN 7, AUDIO IN 8
--------------------	--

#### (3) Type

Select the type of broadcast.

Available Settings	General (default) , BGM, Emergency warning
--------------------	--

#### (6) Mixing setting

This function is used for mixing settings for BGM and general broadcasts.

##### Note

When broadcasts are output to the zones of the VX-3008F or VX-3016F, either one of the broadcast sound sources is output regardless of the mixing setting. BGM/General mixed broadcasts are disabled.

- When "Type" is set to "General"

Available Settings	MIXING* <sup>1</sup> (default), BGM CUT* <sup>2</sup>
--------------------	---

\*<sup>1</sup> Mixes General and BGM broadcasts.

\*<sup>2</sup> Cuts off BGM play in all general broadcast zones, regardless of the BGM side settings.

- When "Type" is set to "BGM"

Set mixing status when the general broadcast MIXING setting is set to MIXING.

Available Settings	REDUCTION* <sup>3</sup> , MIXING* <sup>4</sup> (default)
--------------------	--

\*<sup>3</sup> BGM play in general broadcast zones fades out to the preprogrammed attenuation and time, and both the general broadcast and BGM output are mixed.

\*<sup>4</sup> General broadcast and BGM output are mixed. The BGM volume does not vary during general broadcast.

- When "Type" is set to "Emergency warning"

Available Settings	BGM CUT (default)* <sup>5</sup> , MIXING* <sup>6</sup>
--------------------	--

\*<sup>5</sup> Cuts off BGM play in all Emergency warning broadcast zones, regardless of the BGM side settings.

\*<sup>6</sup> Mixes Emergency warning and BGM broadcasts.

**[Mixing setting combinations (Only when making broadcasts to the Zones allocated to the VX-3004F)]**

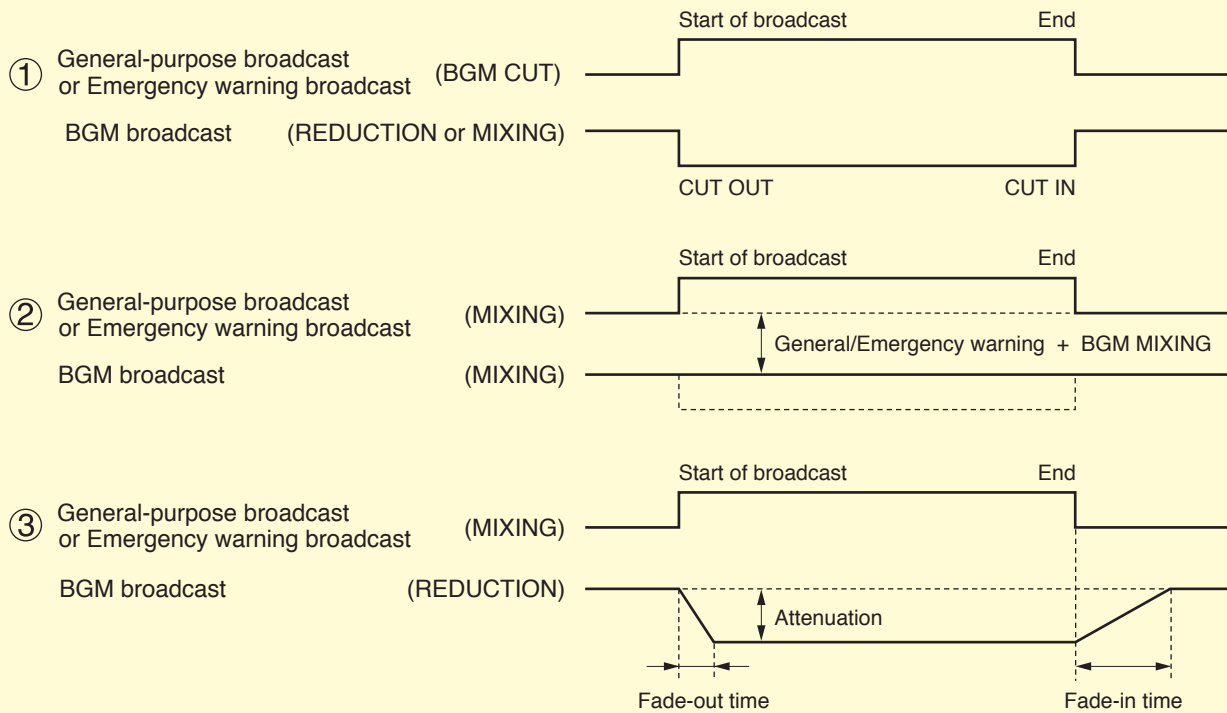

**(5) Fade out**

This selection becomes available when "Mixing setting" is set to "REDUCTION."

Available Settings	0, 0.1, 0.2, 0.5, 1, 2, 3, 4, 5, 6, 7, 8, 9, 10 [sec] (default: 1)
--------------------	--

**(6) Fade in**

This selection becomes available when "Mixing setting" is set to "REDUCTION."

Available Settings	0, 0.1, 0.2, 0.5, 1, 2, 3, 4, 5, 6, 7, 8, 9, 10 [sec] (default: 4)
--------------------	--

**(7) Attenuation**

This selection becomes available when "Mixing setting" is set to "REDUCTION."

Available Settings	-40 [dB] to -1 [dB], -∞ [dB] (default: -40), in 1-dB steps
--------------------	--

**(8) Broadcast between networks (Only when using the network area division function)**

Set whether or not to make broadcast to the different network areas.

Available Settings	Not used (default), Used
--------------------	--------------------------

**Note**

The audio input channel that has been set to "Not used" is allowed for broadcast only within the network area set to the VX-3000F to which the VX-3000PM is connected.

**7.13.2. Terminal setting**

Clicking the Settings for terminals tab displays the screen as shown below.

Set the VX-3000PM's control input/output terminals.

Set the control input/output name and a control method of the control output.

The number of the control inputs is 20 and that of the control outputs is 10.

**(1) Control input setting****• Name**

Enter each name of the control inputs.

Available Settings	Up to 32 alphanumeric characters (Default name: for example, VX0-PM-CIN 1 represents Pin 1 of the control input terminal 1 of the VX-3000PM connected the VX-3000F of ID No. 0.)
--------------------	--

**(3) Control output setting****• Name**

Enter each name of the control outputs.

Available Settings	Up to 32 alphanumeric characters (Default name: for example, VX0-PM-COUT 1 represents the control output terminal 1 of the VX-3000PM connected the VX-3000F of ID No. 0.)
--------------------	---

**• Output method**

Set the output control method of the control output.

Available Settings	Level (default), Pulse
--------------------	------------------------

**• Output time**

When "Pulse" is selected for the output control method of the control output, set the pulse width.

Available Settings	1 [sec] to 60 [sec] (default: 1), in 1-sec steps
--------------------	--

## 8. NETWORK SETTINGS

Clicking the network settings button displays the screen below.  
Perform settings related to a network for the VX-3000 system components.

[Device individual display]

The screenshot shows the 'VX-3000 Setting Software' window. The left sidebar contains various setting categories. The main area displays three tables for different units, and the right sidebar contains network common settings.

**(1) Network settings button**

**(2) Broadcast setting button**

**(3) Network unit table**

Unit settings	IP Address	Subnet mask	Default gateway
None	192.168.14.100	225.255.255.0	0.0.0.0
None	192.168.14.101	225.255.255.0	0.0.0.0
None	192.168.14.102	225.255.255.0	0.0.0.0
None	192.168.14.103	225.255.255.0	0.0.0.0
None	192.168.14.104	225.255.255.0	0.0.0.0
None	192.168.14.105	225.255.255.0	0.0.0.0
None	192.168.14.106	225.255.255.0	0.0.0.0
None	192.168.14.107	225.255.255.0	0.0.0.0

**(4) Network common setting**

System name : VX-3000 System

Audio multicast address  
 VX-3000F : [ 225 ] 0.xxx0 - 225.0.xxx7  
 VX-3000PM : 225 .0.yyy0 - 225.0.yyy:14  
                   xxx VX-3000F ID  
                   yyy: 51+Connected VX-3000F ID

Audio packet size (byte) : 512

UDP Port  
 Audio network Start Port (Multicast) : 5000  
 Audio network End Port (Multicast) : 5349  
 Audio network Start Port (Unicast) : 6000  
 Audio network End Port (Unicast) : 6013

TCP Port  
 Port for unit communication : 35285  
 Port for PC setting software : 50000  
 Remote control Start Port : 50050  
 Remote control End Port : 50053  
 Port for Modbus : 502

Server settings  
 DNS server : 0.0.0.0  
 NTP server : ntp.VX.3000.com

[Network area individual display]

The screenshot shows the 'VX-3000 Setting Software' window. The left sidebar contains various setting categories. The main area displays two tables for different network areas, and the right sidebar contains network common settings.

**(1) ID list button**

**(2) Broadcast setting button**

**(3) Network unit table**

Unit settings	IP Address	Subnet mask	Default gateway
None	192.168.14.100	225.255.255.0	0.0.0.0
None	192.168.14.101	225.255.255.0	0.0.0.0
None	192.168.14.102	225.255.255.0	0.0.0.0
None	192.168.14.103	225.255.255.0	0.0.0.0
None	192.168.14.104	225.255.255.0	0.0.0.0
None	192.168.14.105	225.255.255.0	0.0.0.0
None	192.168.14.106	225.255.255.0	0.0.0.0
None	192.168.14.107	225.255.255.0	0.0.0.0

**(4) Network common setting**

System name : VX-3000 System

Audio multicast address  
 VX-3000F : [ 225 ] 0.xxx0 - 225.0.xxx7  
 VX-3000PM : 225 .0.yyy0 - 225.0.yyy:14  
                   xxx VX-3000F ID  
                   yyy: 51+Connected VX-3000F ID

Audio packet size (byte) : 512

UDP Port  
 Audio network Start Port (Multicast) : 5000  
 Audio network End Port (Multicast) : 5349  
 Audio network Start Port (Unicast) : 6000  
 Audio network End Port (Unicast) : 6013

TCP Port  
 Port for unit communication : 35285  
 Port for PC setting software : 50000  
 Remote control Start Port : 50050  
 Remote control End Port : 50053  
 Port for Modbus : 502

Server settings  
 DNS server : 0.0.0.0  
 NTP server : ntp.VX.3000.com

### (1) Network area list button/ID list button (Only when using the network area division function)

Display method for the network setting of each individual device can be switched.

Clicking the Network list button switches the window to the display by each network area.

Clicking the ID list button switches the window to the display by each device.

**(2) VX-3000F unit, VX-3000PM unit, VX-3000CT unit**

- **Network area name (Only when the network area individual display is shown in the case to use the network area division function)**

You can change the network area name by clicking on it.

Available Settings	Up to 32 alphanumeric characters (Default name: Network Area 0 – 7)
--------------------	---

- **IP Address**

You can change IP address by clicking on it.

**[When the network area division function is not used]**

Default setting of each device is "192.168.14.xxx," and "xxx" portion is assigned as shown below.

In the case of the VX-3000F, it is assigned 1, 2, 3, ... in ascending order of ID number.

In the case of the VX-3000PM, it is assigned 51, 52, ... in ascending order of ID number.

In the case of the VX-3000CT, it is assigned 111, 112, ... in ascending order of ID number.

**[When the network area division function is used]**

Default setting of the device to be connected to "NetworkArea 0" is "192.168.14.xxx," and "xxx" portion is assigned as shown below.

In the case of the VX-3000F, it is assigned 1, 2, 3, ... in ascending order of ID number.

In the case of the VX-3000PM, it is assigned 51, 52, ... in ascending order of ID number.

In the case of the VX-3000CT, it is assigned 111, 112, ... in ascending order of ID number.

Default settings of the devices to be connected to "NetworkArea 1" or later are 192.168.15.xxx, "192.168.16.xxx," "192.168.17.xxx" ... and the like.

- **Subnet mask**

You can change subnet mask by clicking on it. (Default: 255.255.255.0)

- **Default gateway**

You can change default gateway by clicking on it. (Default: 0.0.0.0)

**(3) Network unit**

- **Unit settings**

The audio signals being broadcast in the VX-3000 system can be output via a network and recorded. Up to 8 NX-300 Network audio adaptor units can be used as external devices. Setting can be performed if "NX-300" is selected.

Available Settings	None (default), NX-300
--------------------	------------------------

- **IP Address**

You can change IP address by clicking on it. (Default: 192.168.14.100 to 192.168.14.107)

- **Subnet mask**

You can change subnet mask by clicking on it. (Default: 255.255.255.0)

- **Default gateway**

You can change default gateway by clicking on it. (Default: 0.0.0.0)

**(4) Network common setting**

- **Audio multicast address**

You can change multicast address by clicking on it. (Default: 225.0.0.0)

Use the Multicast address for audio signal within the VX-3000 system as follows.

225.0.xxx.0 to 225.0.xxx.7 (VX-3000F)

225.0.yyy.0 to 225.0.yyy.14 (VX-3000PM)

"xxx" shows the VX-3000F's Unit ID.

(Example) When the Unit ID is "1": 225.0.1.0 to 225.0.1.7

"yyy" indication represents the numerical value that 51 is added to the device number of the VX-3000F to which the VX-3000PM is connected.

(Example) When the Unit ID is "1": 225.0.52.0 to 225.0.52.14

- **Audio packet size (byte)**

Refers to the packet size used for the audio signals within the VX-3000 system.

It can be selected from "1024," "512" (default), or "256."

You can reduce the audio signal delay between the devices by reducing the packet size but the sound quality may be degraded when the packet size is reduced depending on the broadcast status on the network. Set the packet size depending on the system status.

#### [UDP port]

- **Audio network Start Port (Multicast)**

You can change audio network start port by clicking on it. (Default: 5000)

- **Audio network End Port (Multicast)**

Audio network end port number is changed in synchronization with the audio network start port number.

- **Audio network Start Port (Unicast)**

You can change audio network start port by clicking on it. (Default: 6000)

- **Audio network End Port (Unicast)**

Audio network end port number is changed in synchronization with the audio network start port number.

#### [TCP port]

- **Port for unit communication**

Used for control between the VX-3000F units.

You can change port for unit communication by clicking on it. (Default: 35285)

**Note**

Be sure to assign the same value to the unit communication port of the VX-3000F unit, and that of the VX-3000PM or VX-3000CT unit ([p. 3-207](#)).

- **Port for PC setting software**

Port for PC setting software is fixed to "50000," which cannot be changed.

- **Remote control Start Port**

You can change start port for remote control by clicking on it. (Default: 50050)

- **Remote control End Port**

Remote control end port number is changed in synchronization with the audio network start port number.

- **Port for Modbus**

You can refer the VX-3000 system status and control the control input terminal statuses from a server PC using the Modbus protocol. Set the port used for remote control. (Default: 502)

**Notes**

- Consult the TOA dealer when using the remote control function.
- Perform the port setting so that it does not overlap with other port settings.
- Modbus protocol is a serial communication protocol developed by the Modicon Inc. (AEG Schneider Automation International S.A.S.) for PLC (Programmable logic controller) use.

#### [Server settings]

- **DNS server**

Enter the DNS server IP address.

- **NTP server**

Enter the URL\* or IP address of the NTP server.

The NTP server is invalid when this field is blank. It becomes valid when the URL or IP address is entered.

\* The label length must be up to 63 characters and the total URL length up to 253 characters.

## 9. AMPLIFIER CONFIGURATION SETTING

Clicking the Amplifier configuration setting button displays the screen below.

When 2 power amplifier modules are installed in the VX-3008F, set the zones to broadcast from each power amplifier module.

Allocate the zones with the slide switch that determines the zones each amplifier covers.

Orange or blue zones are the output target zones from each amplifier.

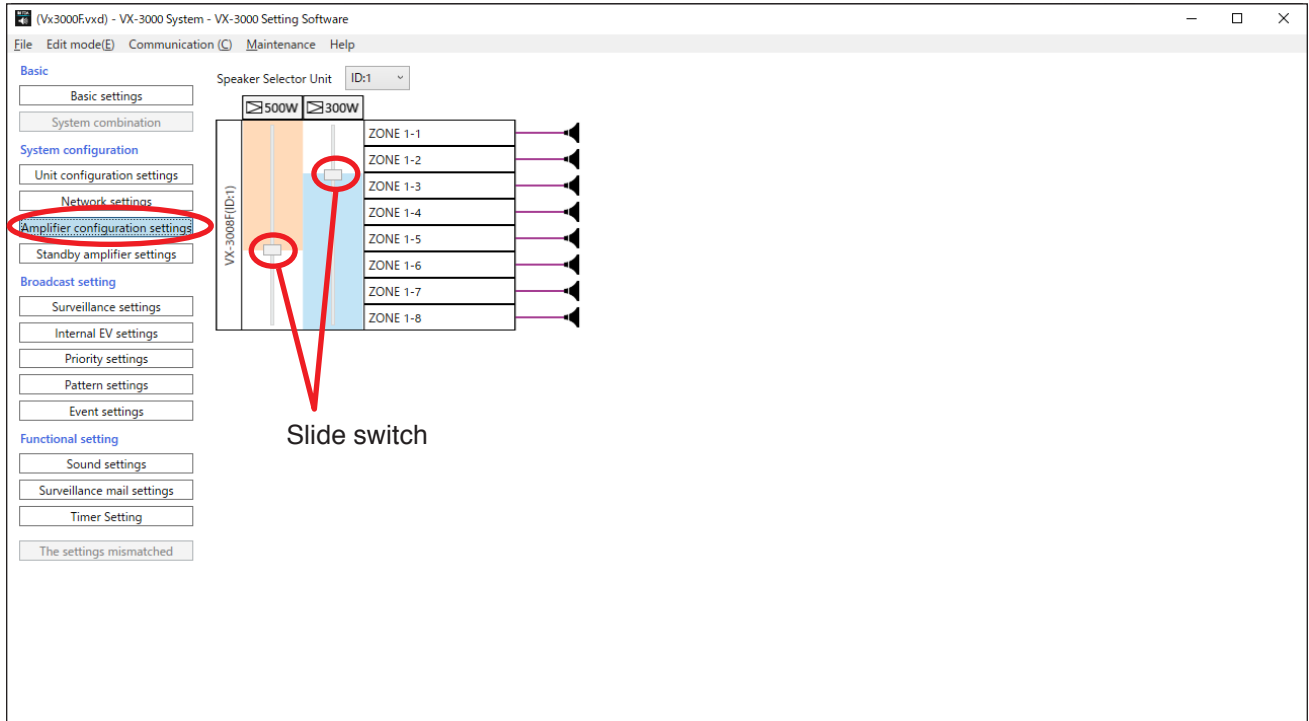

### Notes

- When the control output which is interlocked with the audio output of the zone output has been set (p. 3-57 "Audio output setting"), it is not possible to make broadcast from 2 amplifiers to the same zone. Set the broadcast destinations of 2 amplifiers so as not to overlap with each other as shown at right.
- When the line output modules have been set to the amplifier slots (p. 3-45,) it is not possible to make broadcast from 2 amplifiers to the same zone. Set the broadcast destinations of 2 amplifiers so as not to overlap with each other as shown at right.

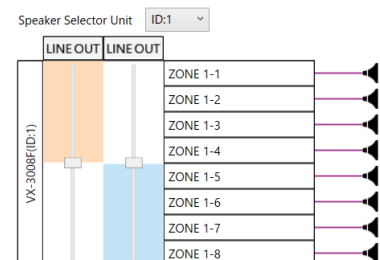
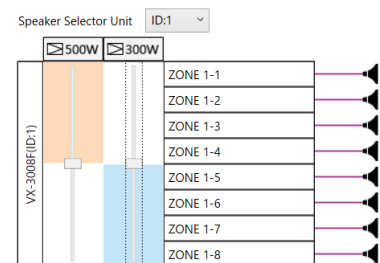

## 10. STANDBY AMPLIFIER SETTINGS

Clicking the Standby amplifier settings button displays the standby amplifier settings screen.

Perform this setting when 2 or more VX-3000F units share a standby amplifier.

VX-3000F units with a standby amplifier are displayed in the right column and those with no standby amplifier in the left column.

### Note

It is possible to select a standby amplifier which has the rated output equal to or larger than the maximum output of the power amplifiers installed to the VX-3000F having no standby amplifier.

However, when the network area division function is used, you cannot set the amplifier that is used for the different network area as standby amplifier.

Also, you cannot set the VX-300LO as standby amplifier.

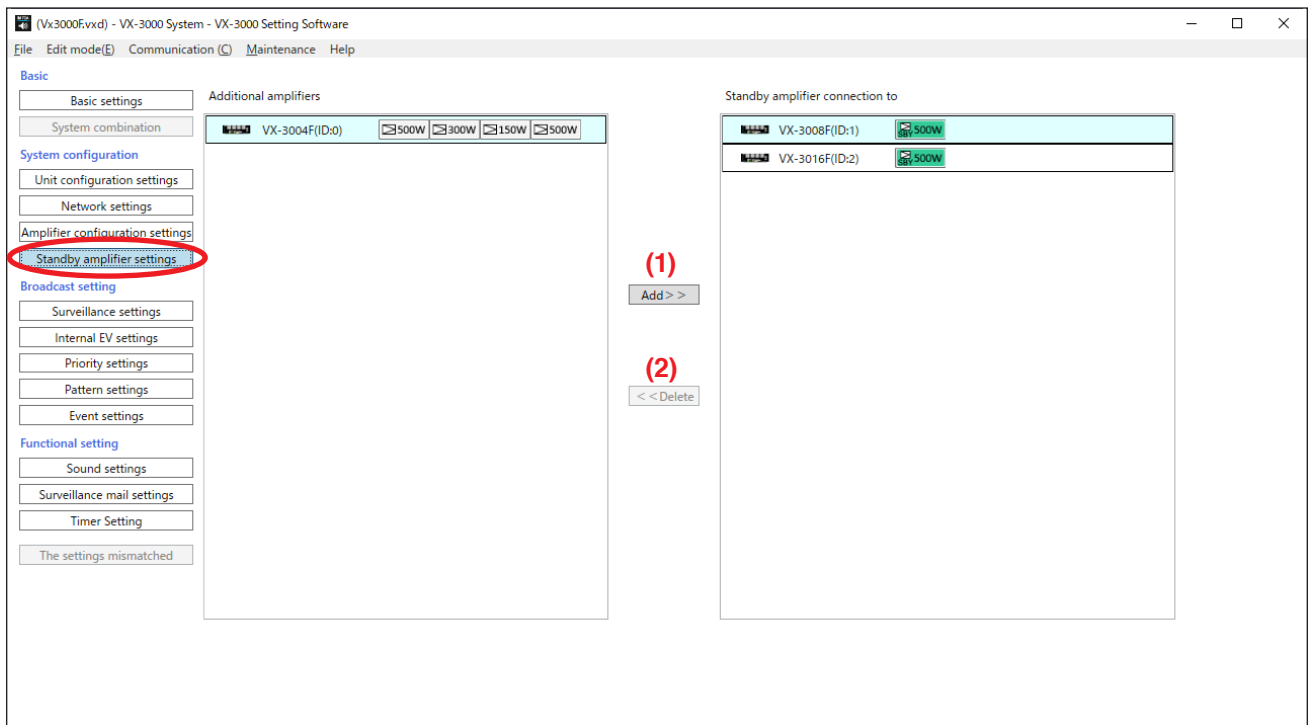

### (1) Add button

Click this button when the VX-3000F that shares the standby amplifier is added to the VX-3000F with a standby amplifier.

### (2) Delete button

Click this button to exclude the VX-3000F to which sharing setting has been made.

## 10.1. Adding a Standby Amplifier

**Step 1.** Click one of the VX-3000F units in the right column to select the VX-3000F with a standby amplifier.

**Step 2.** Click one of the VX-3000F units in the left column to select the VX-3000F that shares the standby amplifier selected in **Step 1**.

**Step 3.** Click the Add button.

The VX-3000F selected in **Step 2** moves below the V-3000F selected in **Step 1**.

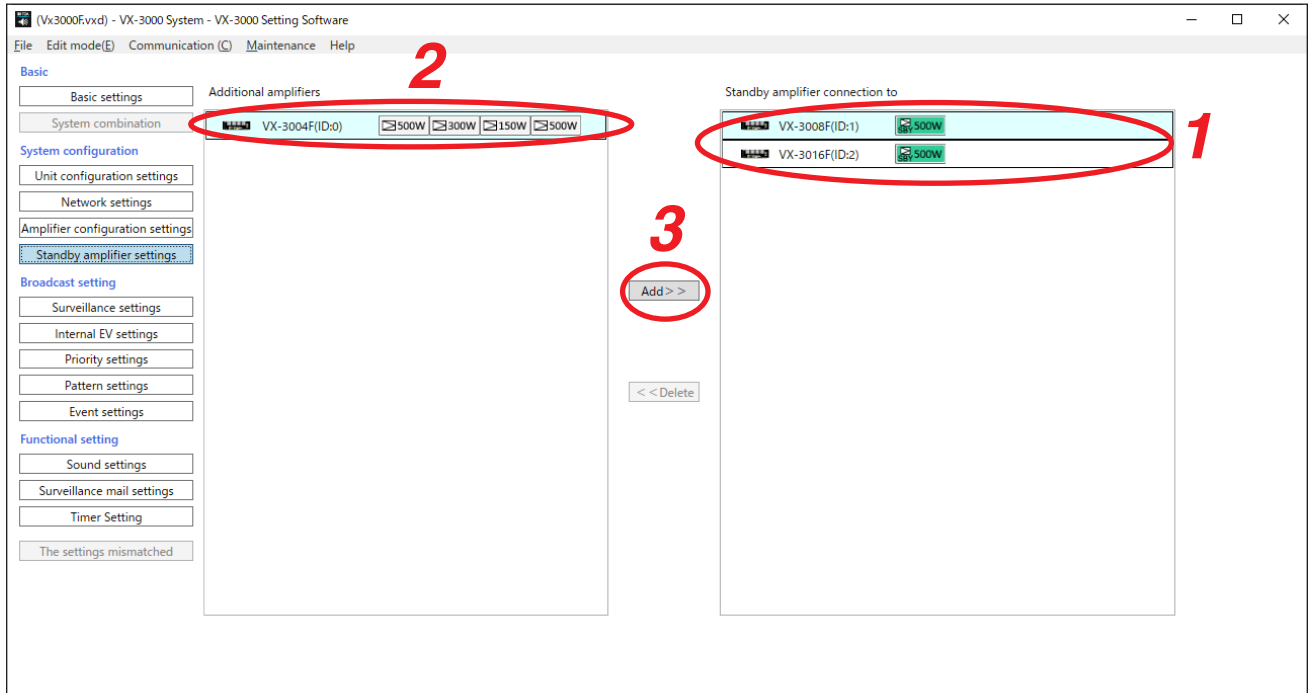

## 10.2. When Not Sharing the Standby Amplifier

**Step 1.** Select one VX-3000F having no standby amplifier out of the VX-3000F units listed in the right column.

**Step 2.** Click the Delete button.

The VX-3000F selected in **Step 1** is excluded from shared use of standby amplifier and moves to the left column.

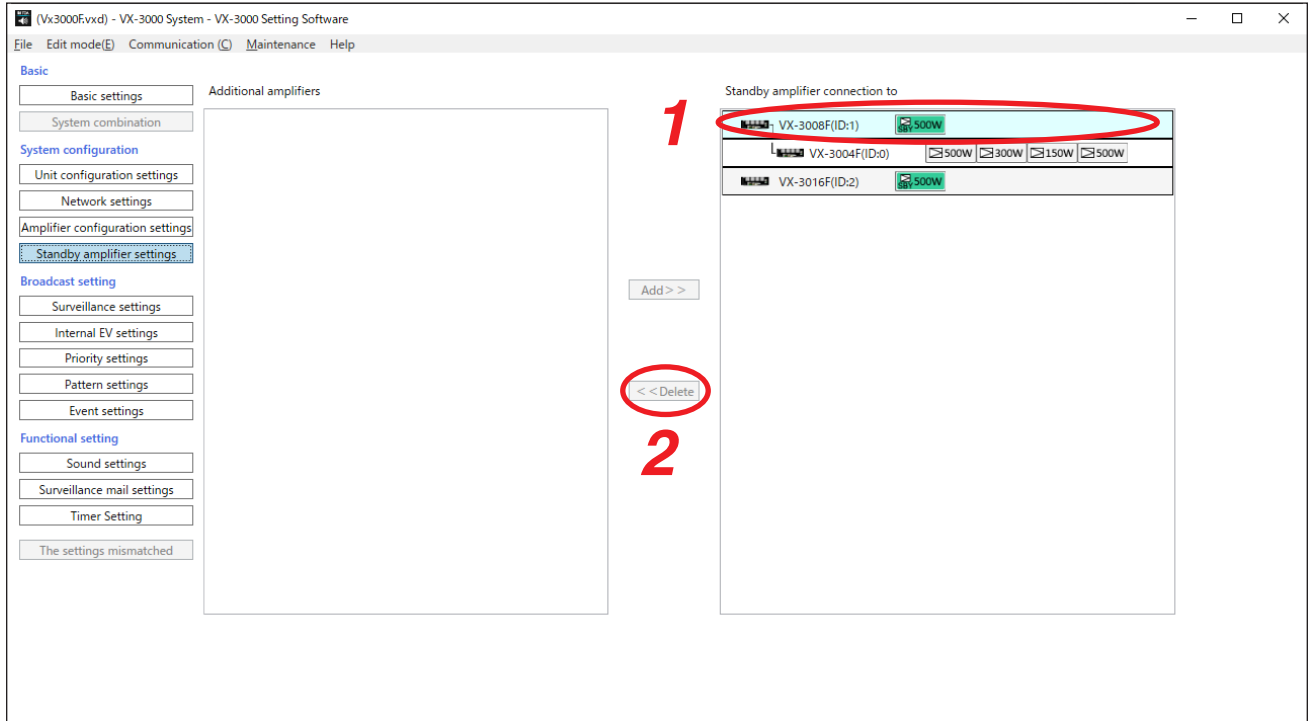

## 11. SURVEILLANCE SETTINGS

The surveillance settings screen below is displayed by clicking the Surveillance settings button, which becomes active when the "Fault detect functions" is set to "Used" in the Common Settings items of the "Basic settings" (p. 3-38).

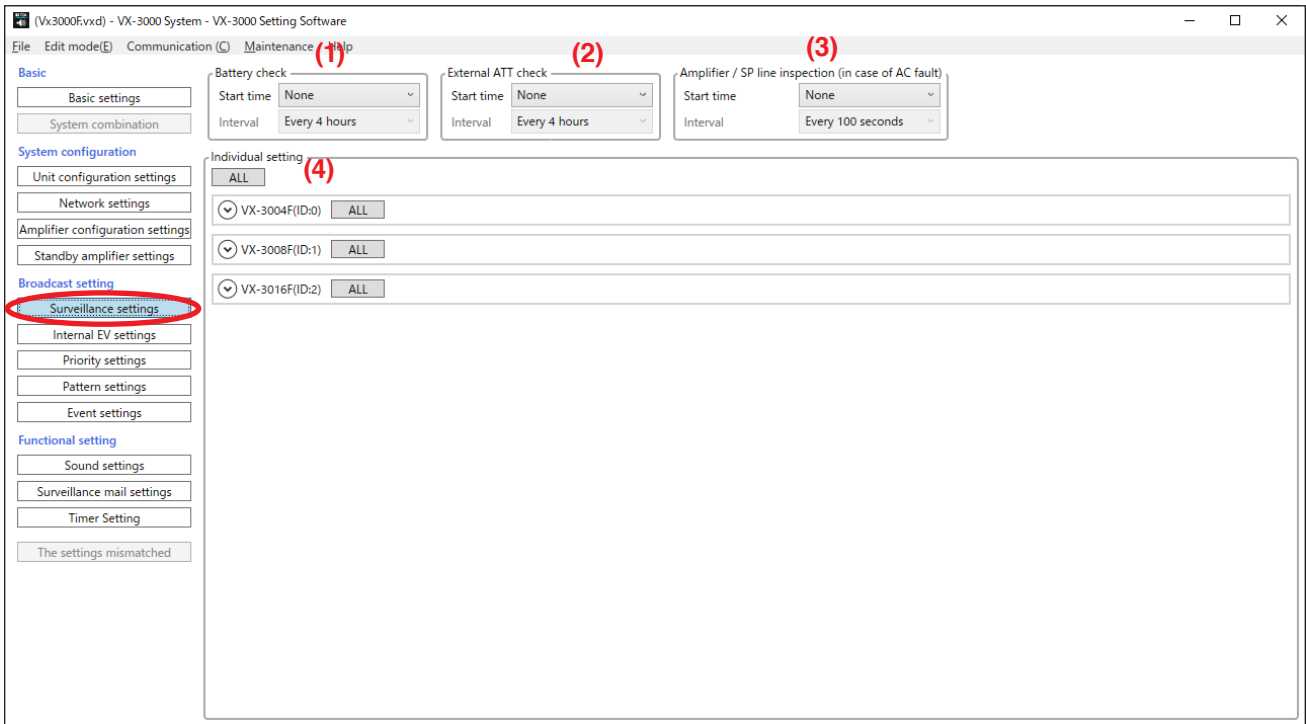

When you set the "Start time" of the surveillance items (1) through (3), Surveillance will start every day at the "Start time" set on the VX-3000. Note that the item (3) starts only in case of AC fault. Set the VX-3000F's clock in the "Time setting" on the maintenance screen. (See p. 24.)

### (1) Battery check

Set the start time and interval to check the conditions of the batteries selected in the Battery item of the Individual settings.

#### • Start time

Available Settings	None (default), 00:00 – 23:00 (in 1-hour steps)
--------------------	---

#### • Interval

This setting item is invalid when "Start time" is set to "None."

Available Settings	Every 4 hours (default), Every 12 hours, Every 24 hours
--------------------	---

### (2) External ATT check

Set the start time and interval to check the conditions of the external attenuator-connected speaker lines selected in the speaker item of the Individual settings.

#### • Start time

Available Settings	None (default), 00:00 – 23:00 (in 1-hour steps)
--------------------	---

#### • Interval

This setting item is invalid when "Start time" is set to "None."

Available Settings	Every 2 hours, Every 4 hours (default), Every 12 hours, Every 24 hours
--------------------	--

### (3) Amplifier/SP line inspection (in case of AC fault) or Amplifier/SP line inspection (during power failure/sleep)

Set the start time and interval for the amplifiers' and speaker lines' fault detection.

#### • Start time

Available Settings	None (default), 00:00 – 23:00 (in 1-hour steps)
--------------------	---

#### • Interval

This setting item is invalid when "Start time" is set to "None."

Available Settings	Every 100 seconds (default), Every 10 minutes, Every 30 minutes, Every hour, Every 6 hours, Every 12 hours, Every 24 hours
--------------------	--

### (4) Individual setting

Set each surveillance function to ON or OFF. Mark the corresponding checkboxes to use this function. (Default: OFF)

The surveillance items of all units within the system can be collectively set to ON or OFF when you click the ALL button located below the "Individual setting" indication.

Also, pressing the ALL button in the unit frame turns all the surveillance items of the VX-3000F ON or OFF. When you click the leftmost "v" button (unfold button) in the unit frame, the detailed surveillance items of the unit will be displayed, allowing you to perform ON or OFF setting for individual surveillance items.

Click the "∧" button (fold button) on the upper left to close the window.

The screenshot shows the 'Individual setting' window with two unit frames. The top frame is for unit VX-3004F(ID:0) and the bottom for VX-3008F(ID:1). Each frame has an 'ALL' button and a 'v' (unfold) button on the left. The VX-3004F frame shows the following options:

- Main unit:** Analog LINK, LAN A, LAN B, Standby Input, DC Power.
- Amplifier:** Ch1, Ch2, Ch3, Ch4.
- RM:** ID:0, ID:1, ID:2.
- Control input:** 1 through 18.
- Speaker:** A table with columns 'open', 'short', 'earth' and rows 1 through 4.

The VX-3008F frame shows the following options:

- Main unit:** Analog LINK, LAN A, LAN B, DC Power.
- Amplifier:** Ch1, Ch2, Ch3/STANDBY.
- RM:** ID:0.
- Control input:** 1 through 4.
- Speaker:** A table with columns 'open', 'short', 'earth' and rows 1 through 4.

The unit whose surveillance points are selected checks to see;

**Analog LINK:** If the analog link cables are connected correctly.

**LAN A/B:** If the LAN link cables are connected correctly.

**Standby Input:** This item can be checked when the standby amplifier module is not installed and when the standby amplifiers are set in the amplifier setting (p. 3-45) and standby amplifier settings (p. 3-74).

If the standby input cable is connected correctly.

**DC POWER:** If the normal voltage is applied to DC Power Input terminals.

**DS LINK:** This item can be checked when the VX-3000DS is connected to the DS link terminal.

If the VX-3000DS Emergency Power Supply units are operating correctly.

- Amplifier:** If the amplifier is operating correctly for the channel on which the digital power amplifier module is installed. Amplifier statuses to be checked include amplifier connection, fuse, fan, and temperature.  
Only the unit type judgement is done for the channel on which the line output module is installed.
- RM:** If the connected remote microphones are operating correctly, or the cable from the remote microphones are connected.  
**Note**  
Setting the surveillance function of [RM] to "ON" causes an inspection sound to be output from the remote microphone once every 10 seconds in order to check the status of microphone function.
- Control input:** If the control lines from the external devices are connected or shorted.  
**Note**  
When the surveillance function of the control inputs is set to "ON," the control inputs can receive no signal and remain in "inactive" status if the control lines to the set control inputs are disconnected or shorted.
- Speaker:** If the speakers connected to the Speaker Connection terminals are operating correctly. Failure detection ON/OFF for the items of Open, Short, and Earth can be set individually. Clicking on a number selects or clears all horizontal cells, clicking on the character of "Open," "Short," or "Earth" selects or clears all vertical cells, and clicking on the blank part in the upper left corner selects or clears all cells.  
**Notes**
- For the detailed description of Speaker Line Surveillance function, see the separate Installation Manual.
  - For the correct connection at each surveillance point, see the separate Installation Manual, "Connections."
  - When the unit is the VX-3008F or VX-3016F, "earth" allows all zones including the extension units' zones to be targeted for surveillance failure detection. Therefore, checking at least one of the target zones causes all zones including the extension units' zones to be simultaneously checked.
  - This setting is not provided for the zone assigned for the VX-300LO.
- Extension Input 1 (VX-3008F and VX-3016F only):**  
This item can be checked when the VX-3008F or VX-3016F is set as an extension unit\*.  
If the Extension input 1 cable is connected correctly.
- Extension Input 2 (VX-3008F only):**  
This item can be checked when the VX-3008F is set as an extension unit\* of the other VX-3008F with 2 power amplifiers installed.  
If the Extension input 2 cable is connected correctly.
- \* See [the next page "Setting example of the extension unit."](#)

[Setting example of the extension unit]

Extension setting (p. 3-43):  
Extension unit number = 2

Extension setting (p. 3-43):  
Extension unit number = 1

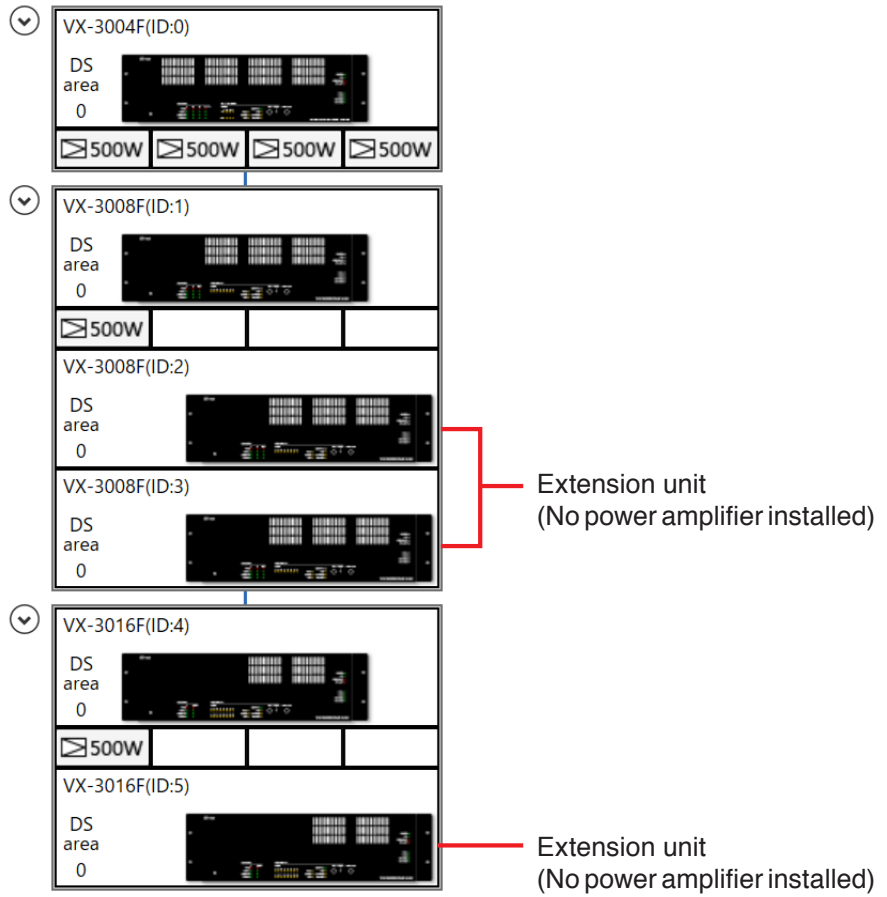

## 12. INTERNAL EV SETTING

Clicking the Internal EV setting button displays the screen below.

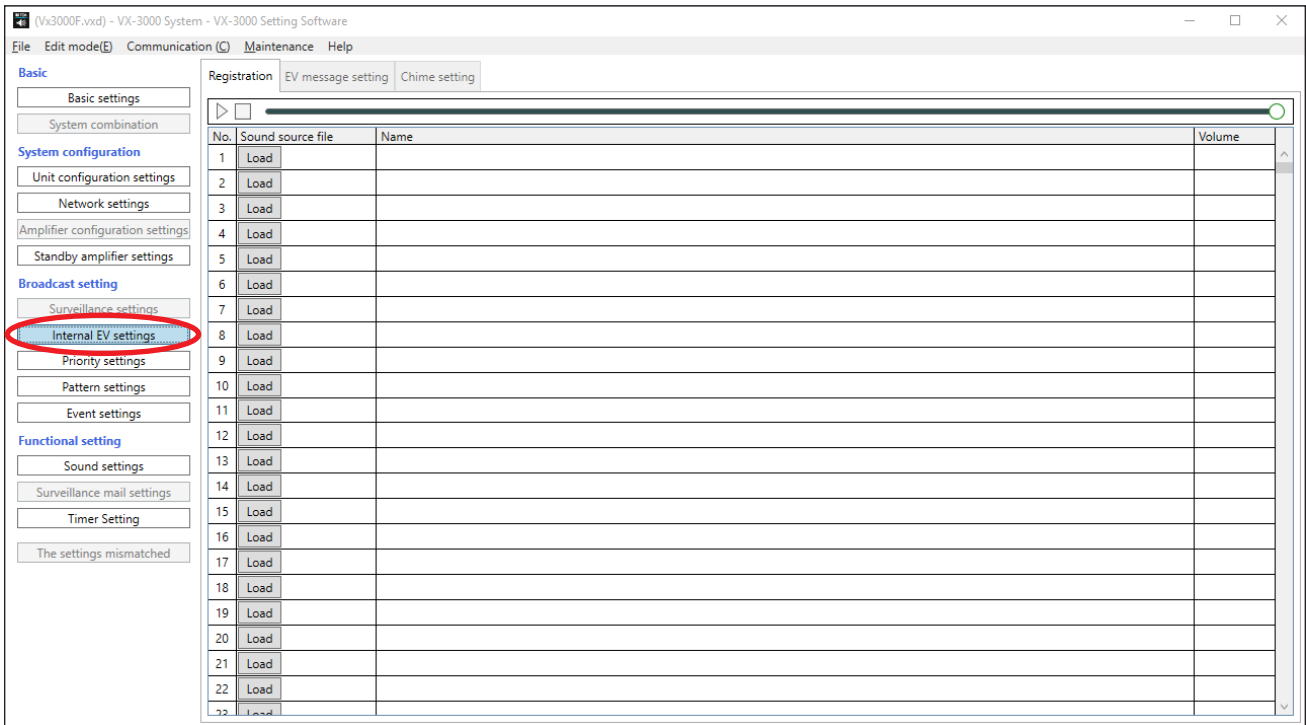

### 12.1. Registration Tab

You can register, delete, and preview the sound source files. Up to 1024 sound source files can be registered in the system. Clicking the Registration tab on the Internal EV setting screen displays the sound source file registration screen.

[Requirements of usable sources for the EV messages and chime]

File format	WAV
Encode	PCM
Sampling frequency	48 kHz
Sampling bit rate	16 bits
Stereo/Monaural	Monaural

#### Note

The size of the sound source files to be registered is up to 400 MB in total.

#### 12.1.1. Registering sound sources

Create the sound source files separately and register them using the steps below.

**Step 1.** Click the Load button to select the sound source file to be used.

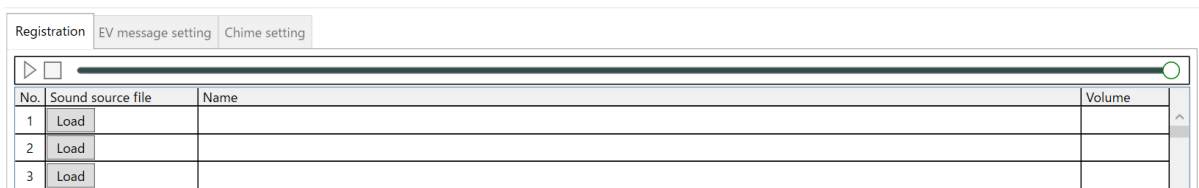

"Open" dialog is displayed.

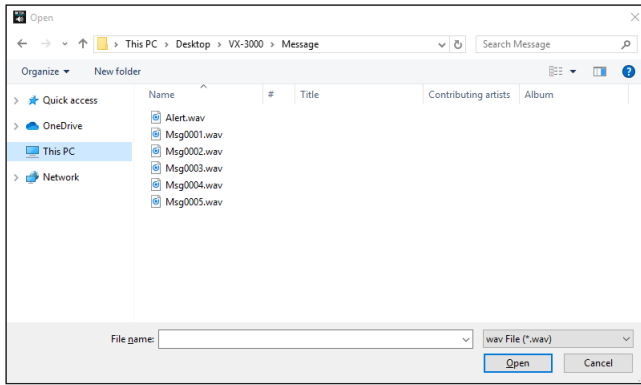

**Step 2.** Designate the folder into which the sound source files have been saved. Then designate the desired sound source file, and click the Open button.

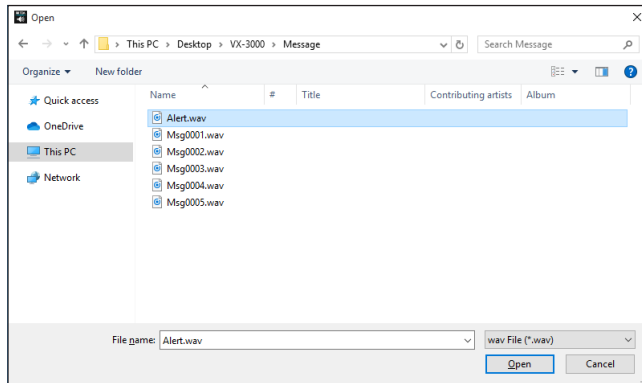

This starts reading the sound source file. When the registration is finished, the EV message screen shown below is displayed.

Registration				EV message setting	Chime setting
No.	Sound source file	Name		Volume	
1	Load	Delete	Play	Alert	0 [dB]
2	Load				
3	Load				

### 12.1.2. Listening the sound sources

Clicking the Play button on the left side of sound source name for the registered sound source file plays back the sound source. The operation buttons above the table become active during playback.

Play button

Stop button

Registration				EV message setting	Chime setting
No.	Sound source file	Name		Volume	
1	Load	Delete	Play	Alert	0 [dB]
2	Load				
3	Load				

### 12.1.5. Deleting the sound source files

**Step 1.** Click the Delete button of the registered sound source file.

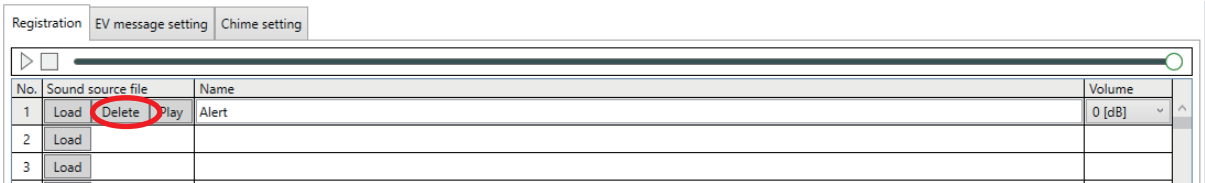

A confirmation dialog is displayed.

**Step 2.** Click the OK button.  
The sound source file is deleted.

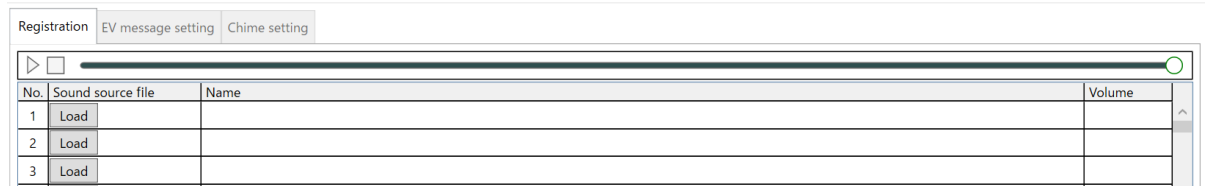
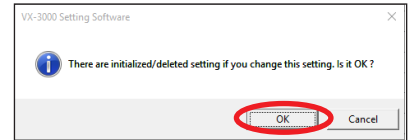

### 12.1.3. Renaming the sound source files

Change the name in the name field of the registered sound source file.  
The file name of the registered sound source file is assigned by default.

Available Settings	Up to 32 alphanumeric characters (Default: File name of the registered sound source file)
--------------------	---

Name is changed to "Alert Message 1" in this example.

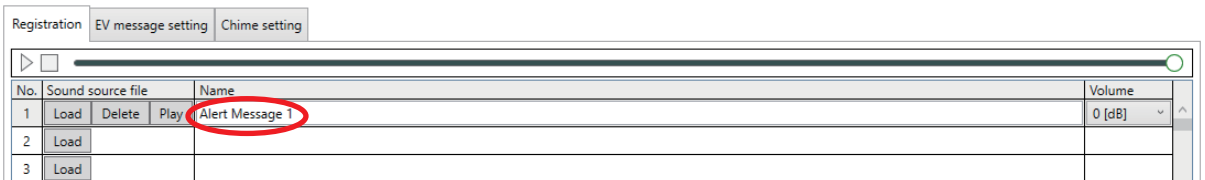

### 12.1.4. Sound source volume

Select the volume of the sound source.

Available Settings	+10 [dB] to -69 [dB] (in 1-dB steps), -∞ [dB] (default: 0 [dB])
--------------------	---

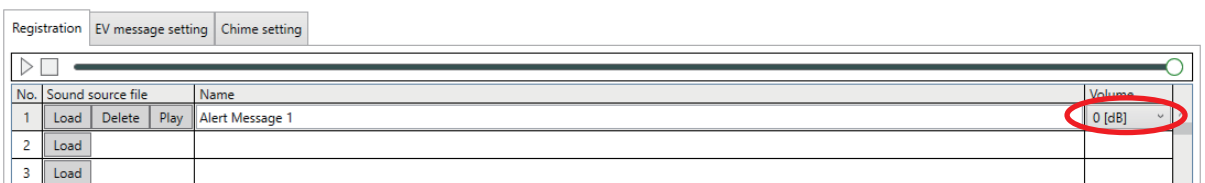

## 12.2. EV Message Setting Tab

You can set the EV message control method and designate the playback sound source file. Clicking the EV message setting tab on the Internal EV setting screen displays the EV message setting screen. Up to 1024 sound source files can be registered as the EV sound sources in the system.

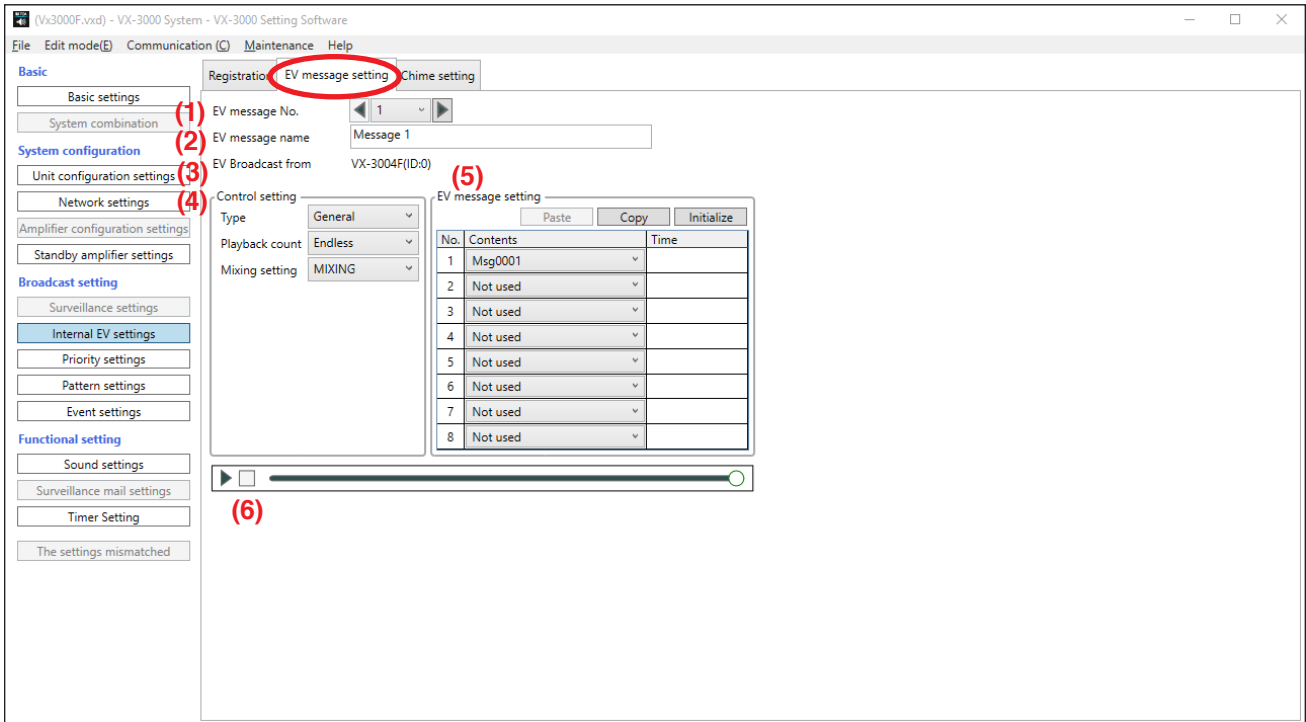

### (1) EV message No.

Set the EV message No.

Available Settings	1 – 1024 (default: 1)
--------------------	-----------------------

### (2) EV message name

Enter the EV message name.

Available Settings	Up to 32 alphanumeric characters
--------------------	----------------------------------

### (3) EV Broadcast from

Displays the VX-3000F unit that broadcasts the EV message when "Type" is set to "General" or "BGM."

Displays the VX-3000F unit for each network area when the network area division function is used.

Network area	EV Broadcast from
NetworkArea 0	VX-3004F(ID:0)
NetworkArea 1	VX-3008F(ID:1)
NetworkArea 2	VX-3016F(ID:2)

### (4) Control setting

#### • Type

Click the "Type" box to select the EV message type. The "Alert" and "Evacuate" messages are used in emergency situation, while the "Restoration" message is used to notify that the emergency situation is over. The "General" and "BGM" EV message can be selected as the sound source in the General Broadcast Pattern Setting. (See p. 3-98.) The "BGM" EV message can be selected as the sound source in the Base Pattern Setting. (See p. 3-96.)

Available Settings	Not used (default), Alert, Evacuate, Restoration, General, BGM
--------------------	--

#### • Playback count

Set the number of times that the EV message is repeated.

The number of times can be selected when "Type" is set to "Alert," "Evacuate," "General," or "BGM."

**[When "Type" is set to "Alert" or "Evacuate"]**

Available Settings	Endless (default), 1, 2, 3
--------------------	----------------------------

**[When "Type" is set to "General" or "BGM"]**

Available Settings	Endless, 1 (default), 2, 3
--------------------	----------------------------

**• Mixing setting**

This function is used for mixing settings for BGM and general broadcasts. Mixing status can be selected when "Type" is set to "General" or "BGM."

**[When "Type" is set to "General"]**

Available Settings	MIXING* <sup>1</sup> (default), BGM CUT* <sup>2</sup>
--------------------	---

\*<sup>1</sup> Mixes general and BGM broadcasts.

\*<sup>2</sup> Cuts off BGM play in all general broadcast zones, regardless of the BGM side settings.

**[When "Type" is set to "BGM"]**

Available Settings	MIXING* <sup>3</sup> (default), REDUCTION* <sup>4</sup>
--------------------	---

\*<sup>3</sup> General broadcast and BGM output are mixed. The BGM volume does not vary during general broadcast.

\*<sup>4</sup> BGM play in general broadcast zones fades out to the preprogrammed attenuation and time, and both the general broadcast and BGM output are mixed.

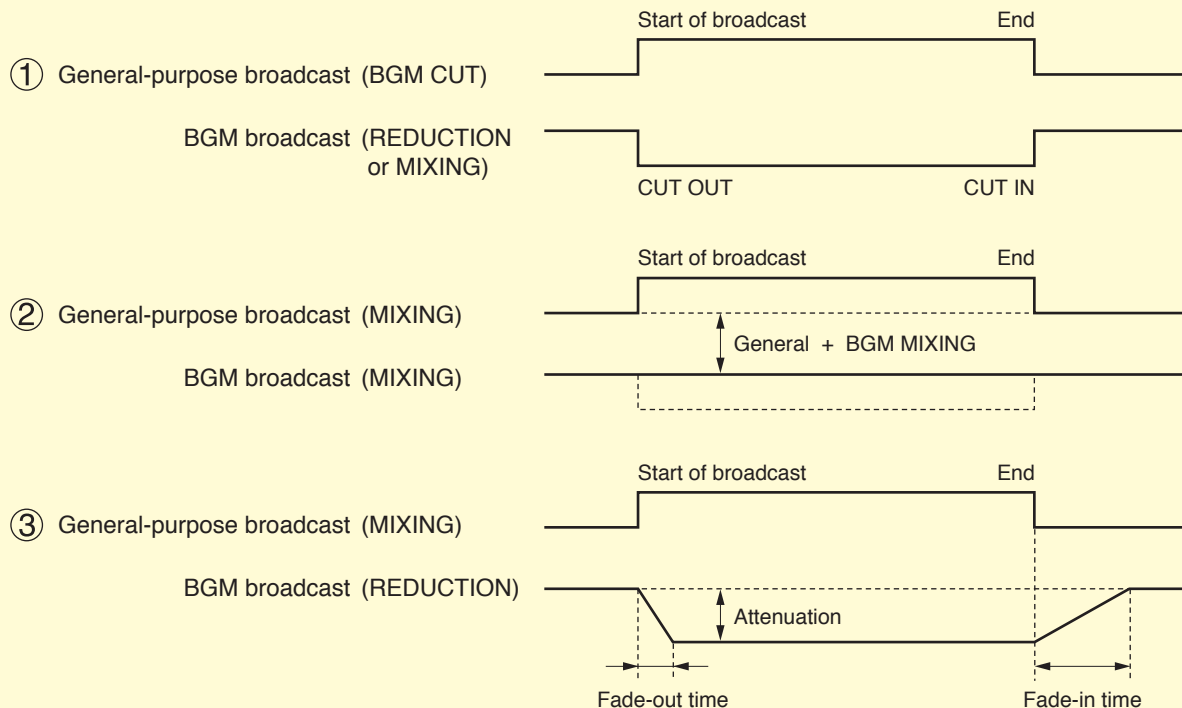
**[Mixing setting combinations (Only when making broadcasts to the Zones allocated to the VX-3004F)]****• Fade out**

This selection becomes available when "Mixing setting" is set to "REDUCTION."

Available Settings	0, 0.1, 0.2, 0.5, 1, 2, 3, 4, 5, 6, 7, 8, 9, 10 [sec] (default: 1)
--------------------	--

**• Fade in**

This selection becomes available when "Mixing setting" is set to "REDUCTION."

Available Settings	0, 0.1, 0.2, 0.5, 1, 2, 3, 4, 5, 6, 7, 8, 9, 10 [sec] (default: 4)
--------------------	--

**• Attenuation**

This selection becomes available when "Mixing setting" is set to "REDUCTION."

Available Settings	-1 [dB] to -40 [dB], -∞ [dB] (default: -40), in 1-dB steps
--------------------	--

**(5) EV message setting**

When "Type" in (4) "Control setting" field is set to "Not used," "EV message setting" field is not displayed. Set the audio source after completing the control setting. The audio source can be configured with up to 8 phrases. The audio source registered on the Registration tab or Silence can be set to each phrase. When set to Silence, also set the silent time as well. The registered phrases 1 through 8 are sequentially broadcast in numerical order. Clicking the Test button (6) allows you to preview the audio source to broadcast by the PC.

- **Copy and Paste buttons**

Clicking the Copy button copies the EV message setting. Select another EV message number. Then, clicking the Paste button pastes the copied parameters in the setting screen of the selected EV message number.

- **Initialize button**

Clicking the Initialize button initializes the EV message setting.

- **Contents**

Set the audio source registered on the Registration tab or Silence.

Available Settings	Registered sound source file name, Silence, Not used
--------------------	--

- **Time (Only when "Contents" is set to "Silence")**

Set the silent time duration in broadcast.

Available Settings	0.1 [sec] – 1.0 [sec] (in 0.1-sec steps), 1.0 [sec] – 25.0 [sec] (in 1-sec steps) (default: 0.5 [sec])
--------------------	--

**(6) Test button**

Allows you to preview the audio source to broadcast using the PC.

## 12.3. Chime Sound Source Tab

You can register, delete, and preview the chime sound source files. Up to 1024 chime sound source files can be registered in the system. Clicking the Chime sound source tab on the Internal EV setting screen displays the chime sound source file registration screen.

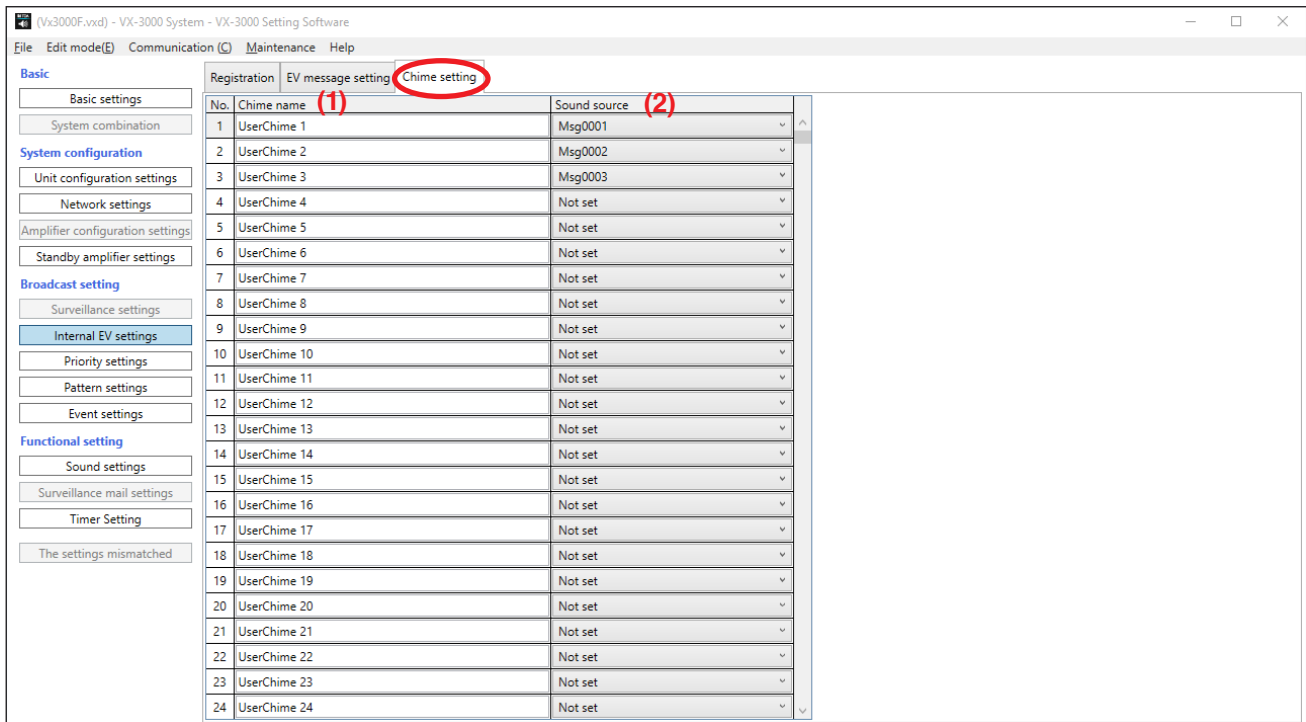

### (1) Chime name

Set the chime name.

Available Settings	Up to 32 alphanumeric characters (default: User Chime #)*
--------------------	---

\* The "#" represents a chime number.

### (2) Sound source

Select the sound source file registered in the Registration tab.

Available Settings	Registered sound source file name (default: Not set)
--------------------	--

### 13. PRIORITY SETTINGS

Clicking the Priority settings button displays the screen below.  
Set input sound source priority levels.

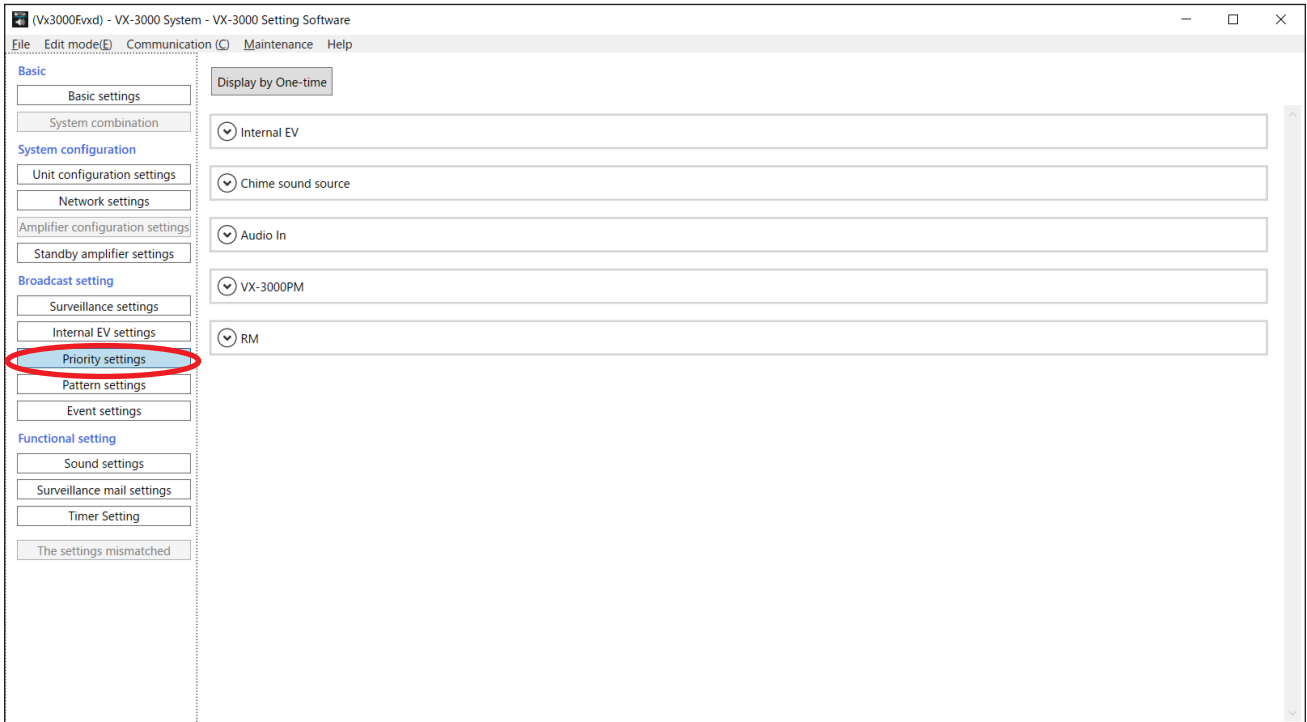

Clicking the leftmost "v" button (unfold button) of each sound source frame unfolds the display, allowing you to perform settings and confirmation.  
Sorting is also possible by clicking the title such as "No." and "Equipment" of the table in the unfolded display.  
Clicking the "A" (fold button) on the upper left of the frame folds the display.

[Display by One-time] button

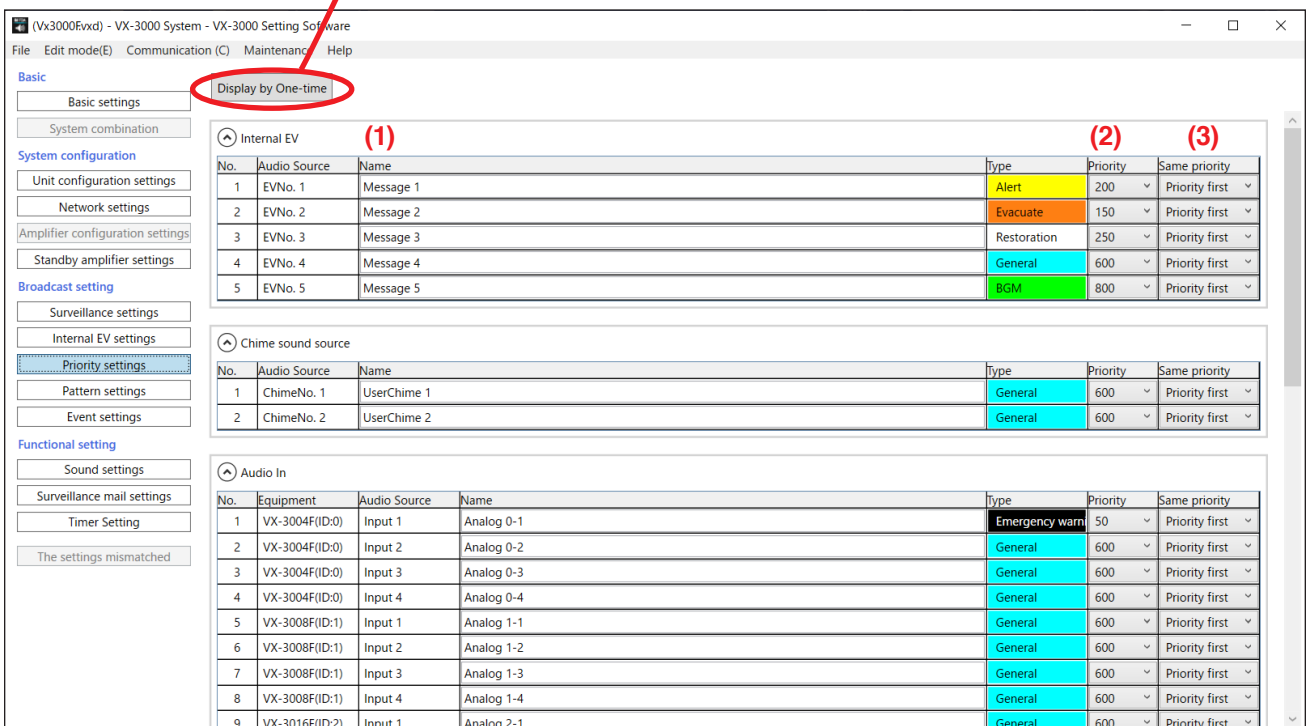

If you click the [Display by One-time] button, you can perform setting and confirmation in a list view. Sorting is also possible by clicking the title such as "No." and "Equipment" of the table in the list display. To return to the original display for each sound source, click the [Display by Individual] button.

[Display by Individual] button

No.	Equipment	Audio Source	Name	Type	Priority	Same priority
1		EVNo. 1	Message 1	Alert	200	Priority first
2		EVNo. 2	Message 2	Evacuate	150	Priority first
3		EVNo. 3	Message 3	Restoration	250	Priority first
4		EVNo. 4	Message 4	General	600	Priority first
5		EVNo. 5	Message 5	BGM	800	Priority first
6		ChimeNo. 1	UserChime 1	General	600	Priority first
7		ChimeNo. 2	UserChime 2	General	600	Priority first
8	VX-3004F(ID:0)	Input 1	Analog 0-1	Emergency warn	50	Priority first
9	VX-3004F(ID:0)	Input 2	Analog 0-2	General	600	Priority first
10	VX-3004F(ID:0)	Input 3	Analog 0-3	General	600	Priority first
11	VX-3004F(ID:0)	Input 4	Analog 0-4	General	600	Priority first
12	VX-3008F(ID:1)	Input 1	Analog 1-1	General	600	Priority first
13	VX-3008F(ID:1)	Input 2	Analog 1-2	General	600	Priority first
14	VX-3008F(ID:1)	Input 3	Analog 1-3	General	600	Priority first
15	VX-3008F(ID:1)	Input 4	Analog 1-4	General	600	Priority first
16	VX-3016F(ID:2)	Input 1	Analog 2-1	General	600	Priority first
17	VX-3016F(ID:2)	Input 2	Analog 2-2	General	600	Priority first
18	VX-3016F(ID:2)	Input 3	Analog 2-3	General	600	Priority first
19	VX-3016F(ID:2)	Input 4	Analog 2-4	General	600	Priority first
20	VX-3000PM(VX0)	Input 1	VX0-PM-Analog 1	General	600	Priority first
21	VX-3000PM(VX0)	Input 2	VX0-PM-Analog 2	General	600	Priority first
22	VX-3000PM(VX0)	Input 3	VX0-PM-Analog 3	General	600	Priority first
23	VX-3000PM(VX0)	Input 4	VX0-PM-Analog 4	General	600	Priority first

### (1) Name

Names of the Audio inputs, Remote microphones, and sound source files can be changed.

Available Settings	Up to 32 alphanumeric characters (Default: Name set in each setting like Audio input setting)
--------------------	---

### (2) Priority

Select priority levels. The smaller the number, the higher the priority level. The priority range that can be set varies depending on the types of the sound sources.

Type	Priority	Default
Emergency	1 – 128	100
Evacuate	129 – 512	150
Alert	129 – 512	200
Restoration	129 – 512	250
General	513 – 1024	600
BGM	513 – 1024	800
Emergency warning	1 – 1024	50

- Emergency: Microphone announcement from the remote microphone of which type is "Emergency" or set to "Emergency/General."
- Evacuation: EV message broadcast of which type is set to "Evacuate."
- Alert: EV message broadcast of which type is set to "Alert."
- Restoration: EV message broadcast of which type is set to "Restoration."
- General: General-purpose pattern broadcast from the sound source of which type is set to "General," and microphone announcement from the remote microphone of which type is set to "General."
- BGM: General-purpose pattern broadcast from the sound source of which type is set to "BGM."
- Emergency warning: Broadcast from the Audio input of which type is set to "Emergency warning."

### Notes

- Here, set the priority level when the BGM sound source is assigned to the general-purpose pattern

broadcast. Priority levels for the "General" and "BGM" to be set here work among general-purpose sound sources or among BGM sound sources, and do not work between general-purpose sound sources and BGM sound sources.

- General-purpose sound sources and BGM sound sources are mixed when the BGM sound source is assigned to the general-purpose pattern broadcast. Volume level of the BGM sound sources can be attenuated in the "Mixing Setting."
- The priority levels set for BGM sources take effect when the BGM sources are assigned to general-purpose broadcast patterns. When the BGM sources are assigned to base patterns, their priority levels are made lowest in the system irrespective of their set priority levels.

### (3) Same priority

Select how to assign priority among multiple input sound sources all set to the same priority level.

#### Note

The control type cannot be set differently for individual sound sources. The control type can be set differently for individual priority level.

Available Settings	Priority last, Priority first (default)
--------------------	---

#### [When set to Priority last (LIFO)]

- Broadcast not possible to zones where a sound source with a higher priority is already broadcasting.
- Broadcasts to zones where a sound source with the same priority is already broadcasting will interrupt and override that broadcast. The original broadcast will resume once the priority broadcast has finished.
- Broadcasts to zones where a sound source with a lower priority is already broadcasting will interrupt and override that lower priority broadcast. The original broadcast will resume once the priority broadcast has finished. However, when the lower priority sound source is a chime sound source (except a start chime and an end chime), this chime sound will not resume even when the priority broadcast has finished.

#### [When set to Priority first (FIFO)]

- Broadcast not possible to zones where a sound source with a higher priority is already broadcasting.
- Broadcast not possible to zones where a sound source with the same priority is already broadcasting.
- Broadcasts to zones where a sound source with a lower priority is already broadcasting will interrupt and override that lower priority broadcast. The original broadcast will resume once the priority broadcast has finished. However, when the lower priority sound source is a chime sound source (except a start chime and an end chime), this chime sound will not resume even when the priority broadcast has finished.

## 14. PATTERN SETTINGS

Clicking the Pattern settings button displays the screen below.

This Pattern setting window allows you to configure 7 patterns such as Zone pattern, Base pattern, and General broadcast pattern, and to make settings for Broadcast among networks and Emergency broadcast status interlocking.

Pattern settings for the emergency sequence, emergency broadcast and Emergency broadcast status interlocking can be selected only when the "Setting for Emergency broadcast functions" has been set to "Used" in the "Basic settings." (p. 3-38)

Pattern settings for the Failure output can be selected only when the "Fault detect function" has been set to "Used" in the "Basic settings." (p. 3-38)

Broadcast among networks setting tab is displayed only when the "Setting for using the network area division function" has been set to "Used" in the "Basic settings." (p. 3-38)

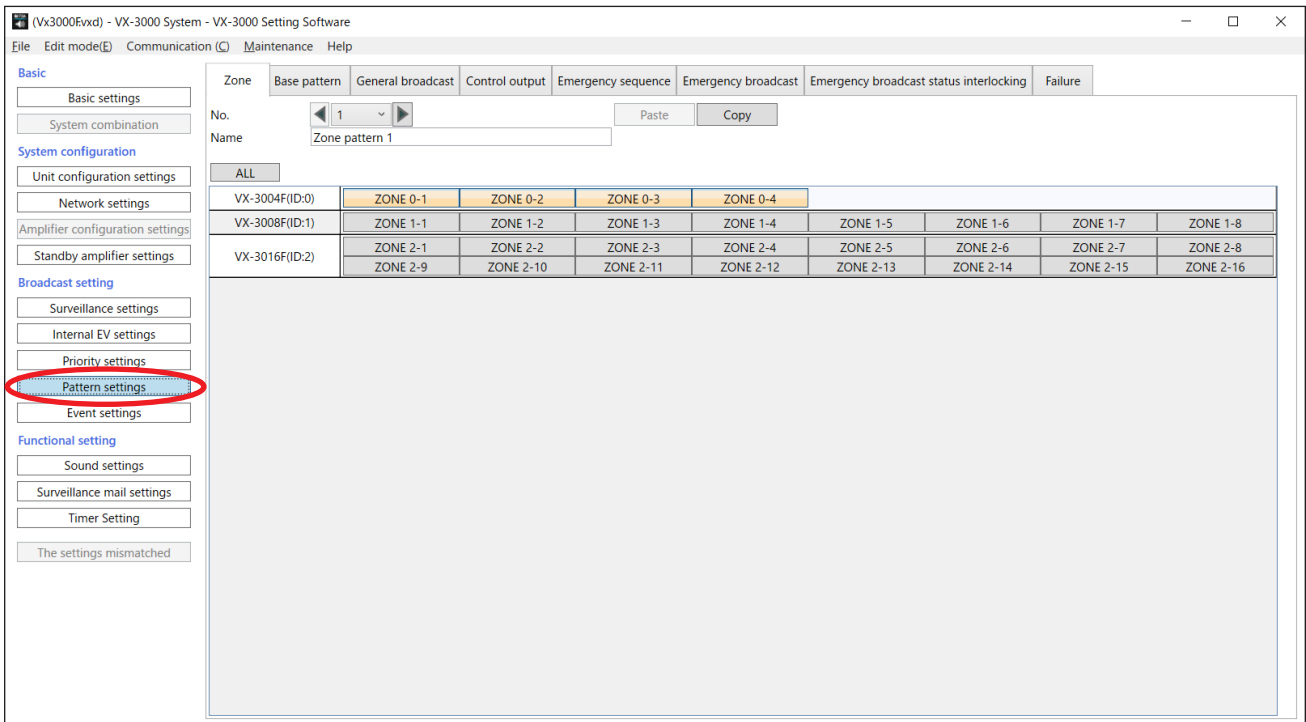

### [Selecting multiple cells]

Multiple cells for each unit or output zone can be selected (or made active) in the setting screens of output zone patterns, base patterns, control output patterns, and failure patterns. This function helps when a system requires multiple units' settings.

The example below shows a method to select multiple output zone when 3 VX-3000F units are used.

#### • Method to select rows of cells for each unit number

To select a row of cells in VX-3004F (ID: 0), move the mouse pointer onto the circled "VX-3004F (ID: 0)" cell.

Unit ID	ZONE 0-1	ZONE 0-2	ZONE 0-3	ZONE 0-4	ZONE 1-1	ZONE 1-2	ZONE 1-3	ZONE 1-4	ZONE 1-5	ZONE 1-6	ZONE 1-7	ZONE 1-8
VX-3004F(ID:0)												
VX-3008F(ID:1)												
VX-3016F(ID:2)												

Click it, and the cells of ZONE 0-1 to ZONE 0-4 in VX-3004F (ID: 0) are all selected.

Unit ID	ZONE 0-1	ZONE 0-2	ZONE 0-3	ZONE 0-4	ZONE 1-1	ZONE 1-2	ZONE 1-3	ZONE 1-4	ZONE 1-5	ZONE 1-6	ZONE 1-7	ZONE 1-8
VX-3004F(ID:0)												
VX-3008F(ID:1)												
VX-3016F(ID:4)												

**Note:** Clicking the "VX-3004F (ID: 0)" cell again cancels this selection.

• Method to select all cells

Click the ALL button.

<b>ALL</b>									
VX-3004F(ID:0)	ZONE 0-1	ZONE 0-2	ZONE 0-3	ZONE 0-4					
VX-3008F(ID:1)	ZONE 1-1	ZONE 1-2	ZONE 1-3	ZONE 1-4	ZONE 1-5	ZONE 1-6	ZONE 1-7	ZONE 1-8	
VX-3016F(ID:2)	ZONE 2-1	ZONE 2-2	ZONE 2-3	ZONE 2-4	ZONE 2-5	ZONE 2-6	ZONE 2-7	ZONE 2-8	
	ZONE 2-9	ZONE 2-10	ZONE 2-11	ZONE 2-12	ZONE 2-13	ZONE 2-14	ZONE 2-15	ZONE 2-16	

All the cells are selected.

<b>ALL</b>									
VX-3004F(ID:0)	ZONE 0-1	ZONE 0-2	ZONE 0-3	ZONE 0-4					
VX-3008F(ID:1)	ZONE 1-1	ZONE 1-2	ZONE 1-3	ZONE 1-4	ZONE 1-5	ZONE 1-6	ZONE 1-7	ZONE 1-8	
VX-3016F(ID:4)	ZONE 4-1	ZONE 4-2	ZONE 4-3	ZONE 4-4	ZONE 4-5	ZONE 4-6	ZONE 4-7	ZONE 4-8	
	ZONE 4-9	ZONE 4-10	ZONE 4-11	ZONE 4-12	ZONE 4-13	ZONE 4-14	ZONE 4-15	ZONE 4-16	

**Note**

Clicking the ALL button again cancels all selection.

**Tip**

When in display mode for each network area, clicking the ALL button allows the selection of all the cells within a single network area.

NetworkArea 0 <b>ALL</b>									
VX-3004F(ID:0)	ZONE 0-1	ZONE 0-2	ZONE 0-3	ZONE 0-4					
NetworkArea 1 <b>ALL</b>									
VX-3008F(ID:1)	ZONE 1-1	ZONE 1-2	ZONE 1-3	ZONE 1-4	ZONE 1-5	ZONE 1-6	ZONE 1-7	ZONE 1-8	
VX-3016F(ID:2)	ZONE 2-1	ZONE 2-2	ZONE 2-3	ZONE 2-4	ZONE 2-5	ZONE 2-6	ZONE 2-7	ZONE 2-8	
	ZONE 2-9	ZONE 2-10	ZONE 2-11	ZONE 2-12	ZONE 2-13	ZONE 2-14	ZONE 2-15	ZONE 2-16	

## 14.1. Output Zone Pattern Setting

Clicking the Zone tab on the pattern settings screen allows output zone patterns to be set.

By allocating set output zone patterns to various broadcast patterns, broadcasts (General broadcast and Emergency broadcast) can be made to any desired zones.

When using the network area division function, you can switch the display mode between ID list display and Network area list display.

[When the network area division function is not used]

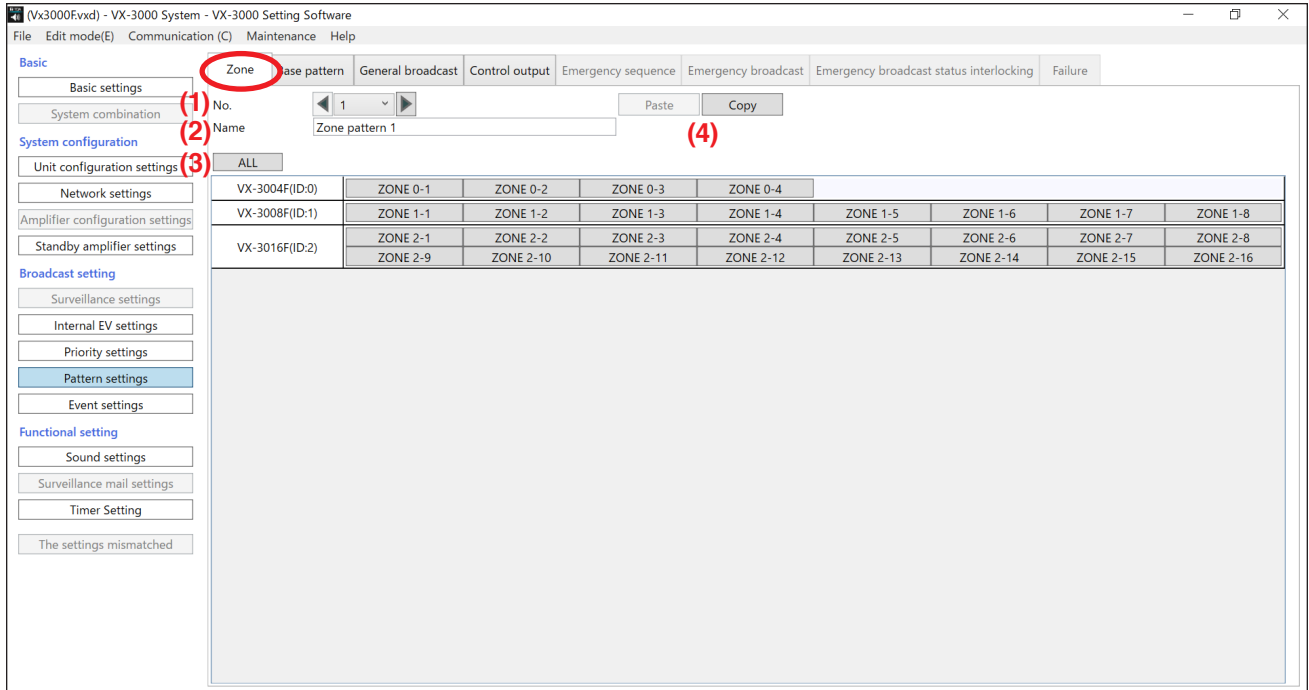

[When ID list display is selected in the case to use the network area division function]

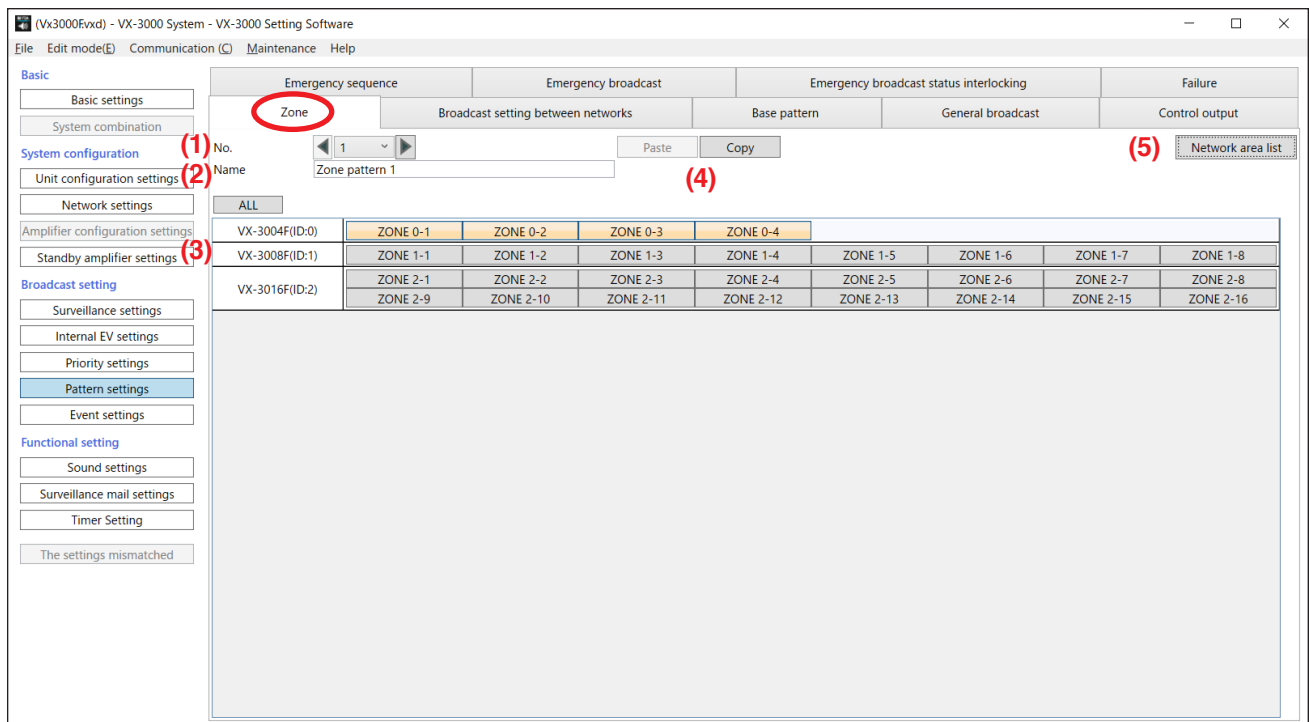

[When Network area list display is selected in the case to use the network area division function]

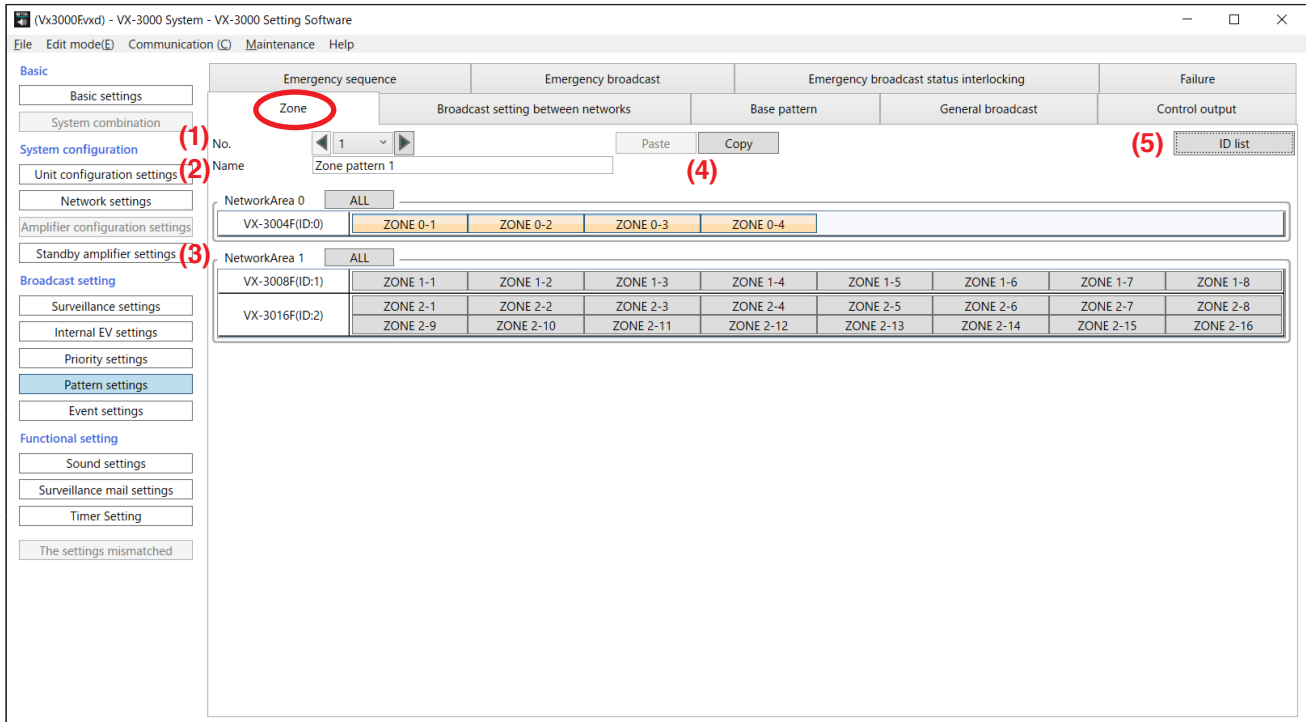

### (1) No.

Click the box or the arrow buttons to select the output zone pattern number.

Available Settings	1 – 1024 (default: 1)
--------------------	-----------------------

### (2) Name

Enter the name of the output zone pattern.

Available Settings	Up to 32 alphanumeric characters (default: Zone pattern 1 – 1024)
--------------------	---

### (3) Zone ON/OFF buttons

Click the buttons corresponding to the zones to use.

**Tip:** For quick selection of multiple cells, see p. 3-91 "Selecting multiple cells."

Available Settings	On (orange), Off (gray, default)
--------------------	----------------------------------

[When set to "On"]

VX-3004F(ID:0)	ZONE 0-1
----------------	----------

### (4) Copy and Paste buttons

Clicking the Copy button copies all of the on-screen settings except "Name" (2) preset by default.

Select another output zone pattern number. Then, clicking the Paste button pastes the copied parameters in the setting screen of the selected "No." (1).

### (5) Network area list button/ID list button (Only when using the network area division function)

Display method for the network setting of each individual device can be switched.

Clicking the Network list button switches the window to the display by each network area.

Clicking the ID list button switches the window to the display by each device.

## 14.2. Broadcast Setting Between Networks

Only when the network division function is used, clicking the Broadcast among networks setting tab causes the screen below to be displayed.

Set to which other networks to broadcast the VX-3000PM's audio input of which "Broadcast among networks" is set to "Used" in the audio input setting of the VX-3000PM.

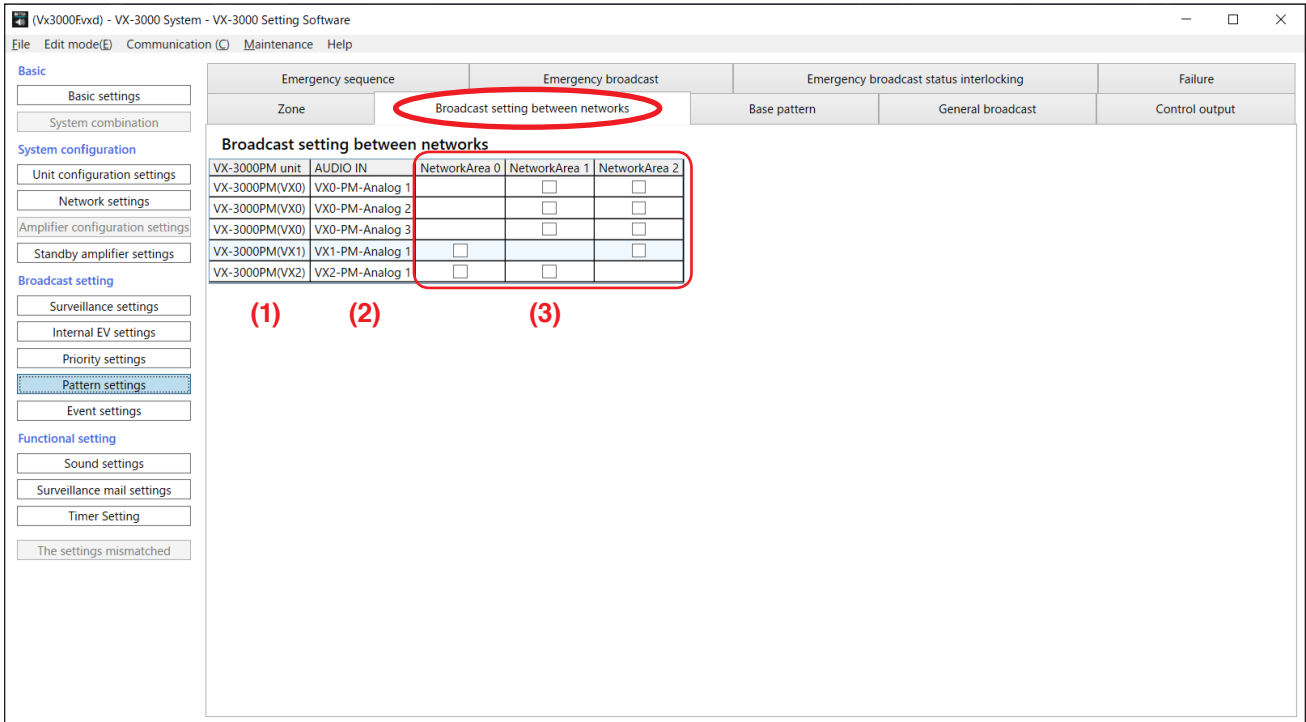

### (1) VX-3000PM unit

The VX-3000PM having the audio input that is used for the broadcast among networks is displayed. For example, "VX-3000PM (VX0)" represents the VX-3000PM connected to the VX-3000F (ID: 0).

### (2) AUDIO IN

The audio input that is used for the broadcast among networks is displayed.

For example, "VX0-PM-Analog 1" represents the VX-3000PM's Audio input 1 connected to the VX-3000F (ID: 0).

### (3) Network Area

Network area name set within the system is displayed.

You can select the network area other than the one where the VX-3000F to which the VX-3000PM is connected belongs.

Checking this item by clicking the checkbox enables broadcast among networks to be made.

#### Notes

- The number of the settable output destinations per VX-3000PM is up to 7. (Up to 7 in the red frame shown below)
- Note that the number of the input audios distributed to a single network area must not exceed the number of the VX-3000PM units within the area multiplied by 7. (Settable maximum number in the blue frame shown below is the number of the VX-3000PM units within the network area multiplied by 7.)

(Example)

VX-3000PM unit	AUDIO IN	NetworkArea 0	NetworkArea 1	NetworkArea 2
VX-3000PM(VX0)	VX0-PM-Analog 1	<input type="checkbox"/>	<input type="checkbox"/>	<input type="checkbox"/>
VX-3000PM(VX0)	VX0-PM-Analog 2	<input type="checkbox"/>	<input type="checkbox"/>	<input type="checkbox"/>
VX-3000PM(VX0)	VX0-PM-Analog 3	<input type="checkbox"/>	<input type="checkbox"/>	<input type="checkbox"/>
VX-3000PM(VX1)	VX1-PM-Analog 1	<input type="checkbox"/>	<input type="checkbox"/>	<input type="checkbox"/>
VX-3000PM(VX2)	VX2-PM-Analog 1	<input type="checkbox"/>	<input type="checkbox"/>	<input type="checkbox"/>

### 14.3. Base Pattern Setting

Clicking the Base pattern tab on the pattern settings screen allows base patterns to be set.

[When the network area division function is not used]

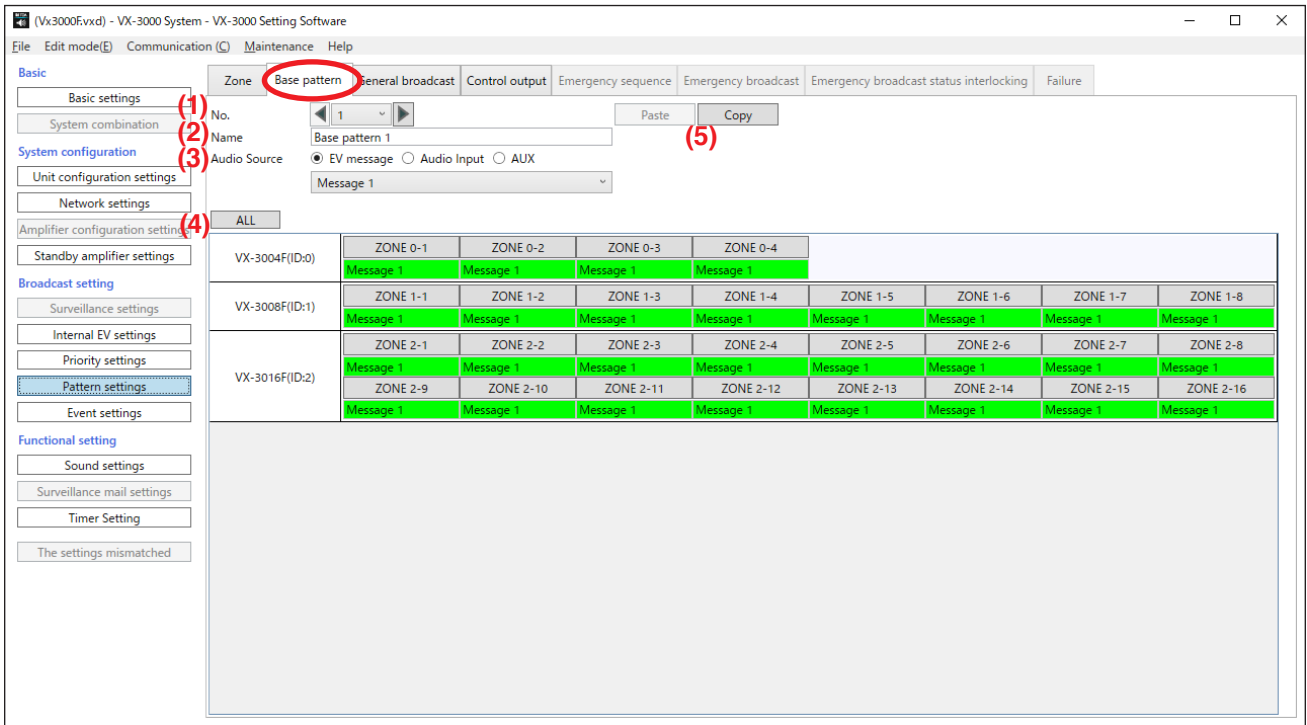

[When ID list display is selected in the case to use the network area division function]

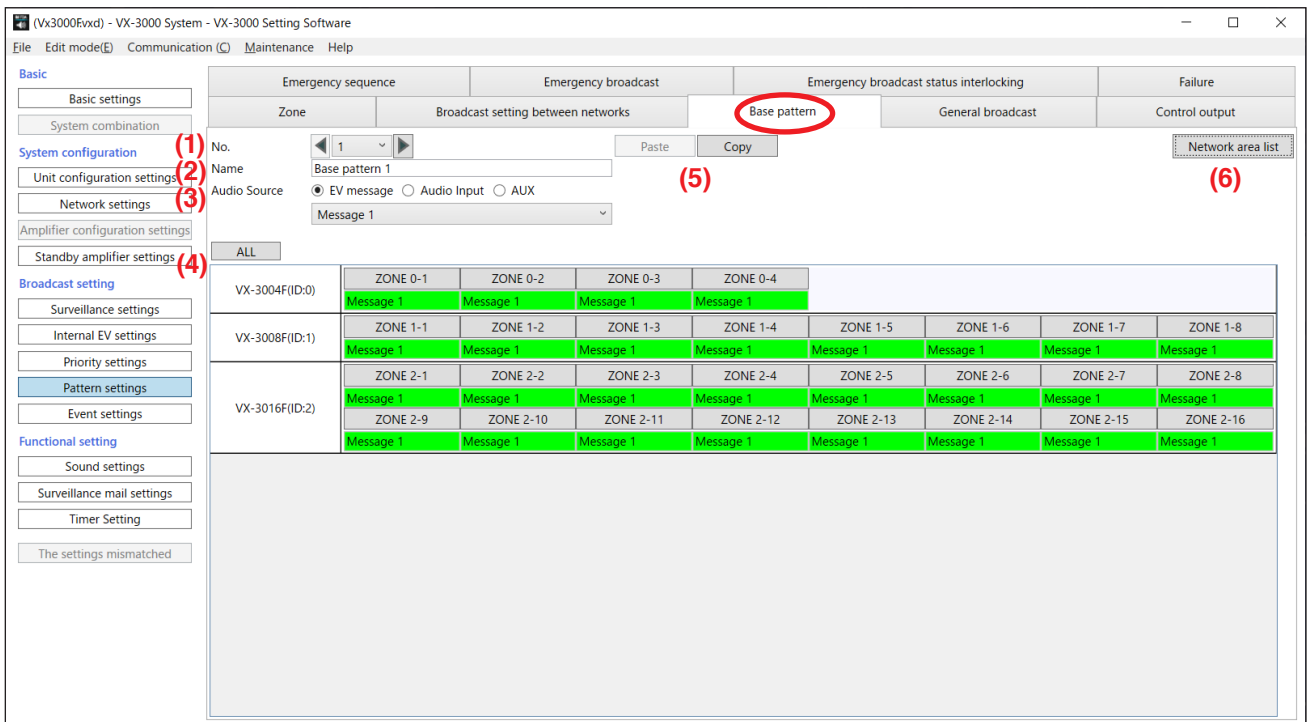

[When Network area list display is selected in the case to use the network area division function]

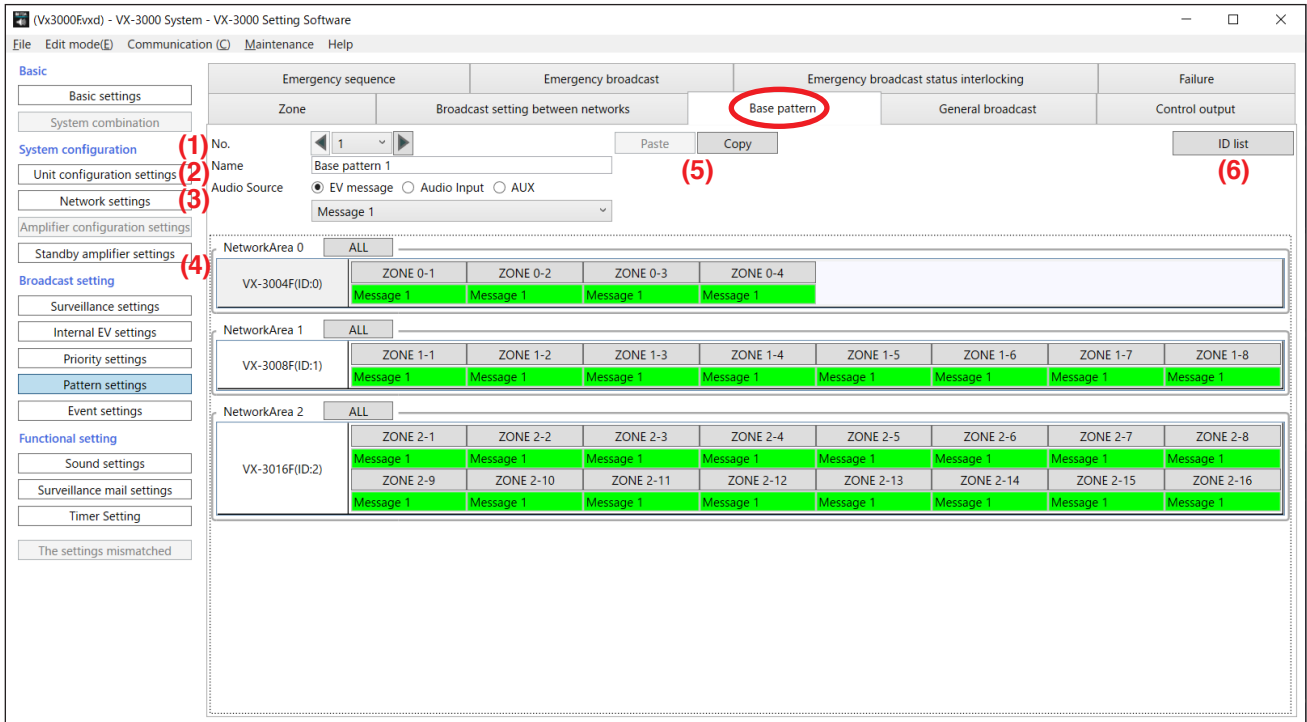

**(1) No.**

Click the box or the arrow buttons to select the base pattern number.

Available Settings	1 – 32 (default: 1)
--------------------	---------------------

**(2) Name**

Enter the name of the base pattern.

Available Settings	Up to 32 alphanumeric characters (default: Base pattern 1 – 32)
--------------------	---

**(3) Audio source**

Select the audio source type with a radio button, then select the audio source from the pull-down list. This can be selected when the broadcast "Type" is set to "BGM." (See p. 3-55, p. 3-66, and p. 3-84.)

Available Settings	None (default), Set audio source name
--------------------	---------------------------------------

**(4) Zone ON/OFF buttons**

Select the zones to use with the "Audio source" (3) above selected. This allows the audio source name to be displayed in the box below the output zone name. The box turns green when the audio source name is displayed.

**Note**

If the audio source is the VX-3000F's audio input (Audio In) or AUX, only the zones within the same network area can be selected.

**Tip**

For quick selection of multiple cells, see p. 3-91 "Selecting multiple cells."

Available Settings	On, Off (default)
--------------------	-------------------

[When set to "On"]

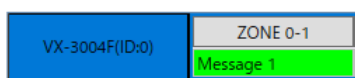

**(5) Copy and Paste buttons**

Clicking the Copy button copies all of the on-screen settings except "Name" (2) preset by default. Select another base pattern number. Then, clicking the Paste button pastes the copied parameters in the setting screen of the selected "No." (1).

**(6) Network area list button/ID list button (Only when using the network area division function)**

Display method for the output zones of each base pattern can be switched.

Clicking the Network list button switches the window to the display by each network area.

Clicking the ID list button switches the window to the display by each device.

**14.4. General Broadcast Pattern Setting**

Clicking the General broadcast tab on the pattern settings screen allows general broadcast patterns to be set.

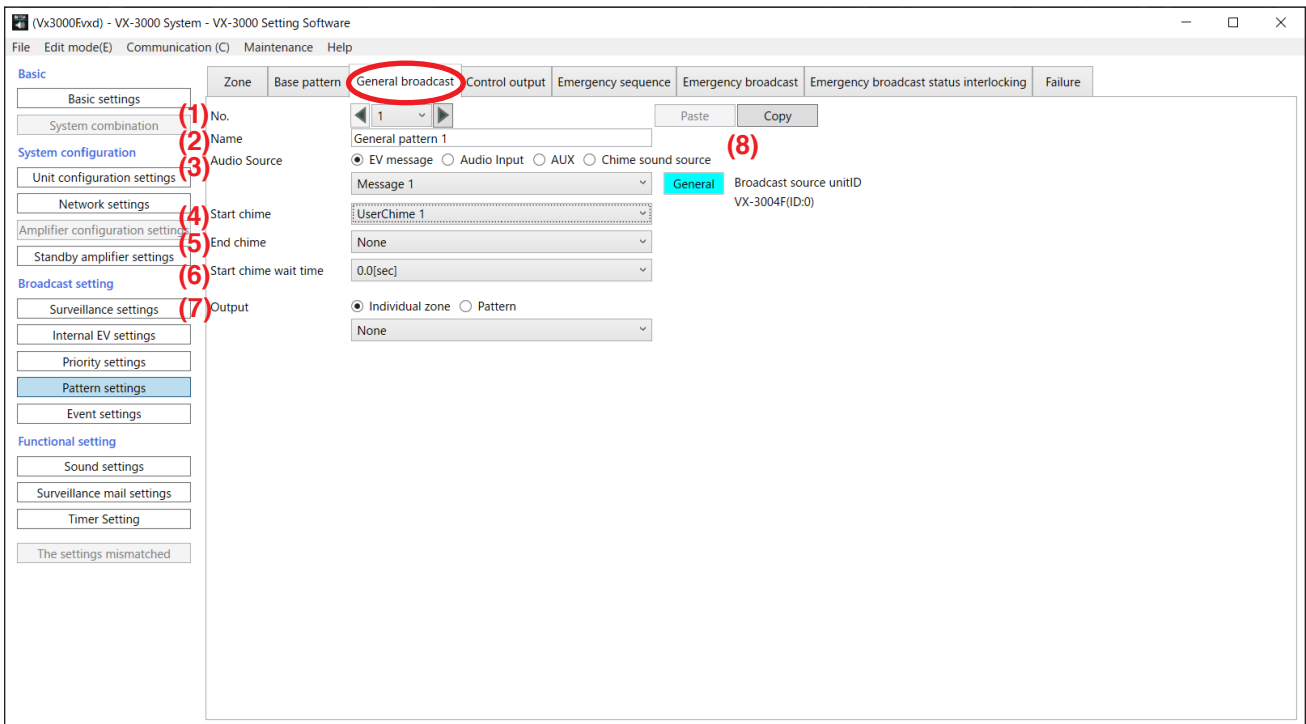
**(1) No.**

Click the box or the arrow buttons to select the general broadcast pattern number.

Available Settings	1 – 1024 (default: 1)
--------------------	-----------------------

**(2) Name**

Enter the name of the general broadcast pattern.

Available Settings	Up to 32 alphanumeric characters (default: General pattern 1 – 1024)
--------------------	--

**(3) Audio source**

Select the audio source type with a radio button, then select the Audio source from the pull-down list.

This can be selected when the broadcast "Type" is set to "General" or "BGM."

The selected type of the audio source and the ID of the broadcast origin unit are displayed at right. When the network area division function is used, the network area of the broadcast origin unit is also displayed.

General	Broadcast source unitID
Network area	EV Broadcast from
NetworkArea 0	VX-3004F(ID:0)
NetworkArea 1	VX-3008F(ID:1)
NetworkArea 2	VX-3016F(ID:2)

Available Settings	None (default), Set audio source name
--------------------	---------------------------------------

**(4) Start chime (Except when the audio source is set to "Chime sound source")**

Select the chime tone at the start of general broadcast.

Available Settings	No chime (default), Set chime sound source names
--------------------	--

**Note**

You can set a start chime for each audio source.

When the same sound source is used in general broadcast patterns, if the chime tone setting in a general broadcast pattern is changed, the change is also reflected to these other general broadcast patterns.

A dialog shown at right will appear when the chime tone is changed.

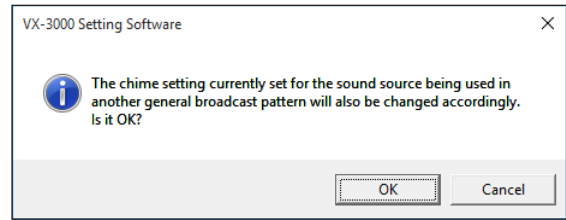
**(5) End chime (Except when the audio source is set to "Chime sound source")**

Select the chime tone at the end of general broadcast.

Available Settings	No chime (default), Set chime sound source names
--------------------	--

**Note**

You can set an end chime for each audio source.

When the same sound source is used in general broadcast patterns, if the chime tone setting in a general broadcast pattern is changed, the change is also reflected to these other general broadcast patterns.

A dialog shown at right will appear when the chime tone is changed.

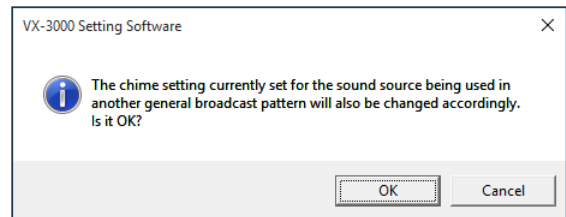
**(6) Start chime wait time (Except when the start chime is set to "Chime sound source" or "No chime")**

Set the time required to start the start chime sounds after the talk key on the remote microphone has been pressed. Select the time according to the start-up time of connected power amplifiers or line selection relays.

Available Settings	0.0, 0.5, 1.0, 1.5, 2.0, 3.0, 4.0 [sec] (default: 0.0)
--------------------	--

**(7) Output**

Select the general broadcast output zones.

Available Settings	Individual zone (default), Pattern
--------------------	------------------------------------

Selecting the "Individual zone" permits the VX-3000F's output zone (Individual) to be selected.

Available Settings	None (default), Output zone (Individual)
--------------------	--

Selecting the "Pattern" allows output zone patterns to be selected.

Available Settings	None (default), Set output zone pattern
--------------------	---

**Tips**

- When the network area division function is used, the output zone pattern name is followed by an asterisk "\*" if the selected output zone pattern includes at least one zone belonging to a different network area so that broadcast cannot be output to such zone.
- Only when the pattern is selected, the setting contents of the output zone pattern will be displayed as shown below.

The display is for view only, and no change can be made here.

VX-3004F(ID:0)	ZONE 0-1	ZONE 0-2	ZONE 0-3	ZONE 0-4				
VX-3008F(ID:1)	ZONE 1-1	ZONE 1-2	ZONE 1-3	ZONE 1-4	ZONE 1-5	ZONE 1-6	ZONE 1-7	ZONE 1-8

Gray: Not designated as the broadcast destination in the selected output zone pattern.

Orange: Designated as the broadcast destination in the selected output zone pattern and broadcast is available with the selected sound source.

Brown: Designated as the broadcast destination in the selected output zone pattern but broadcast is unavailable with the selected sound source.

**(8) Copy and Paste buttons**

Clicking the Copy button copies all of the on-screen settings except "Name" (2) preset by default.

Select another general broadcast pattern number. Then, clicking the Paste button pastes the copied parameters in the setting screen of the selected "No." (1).

**14.5. Control Output Pattern Setting**

Clicking the Control output tab on the pattern settings screen allows control output patterns to be set.

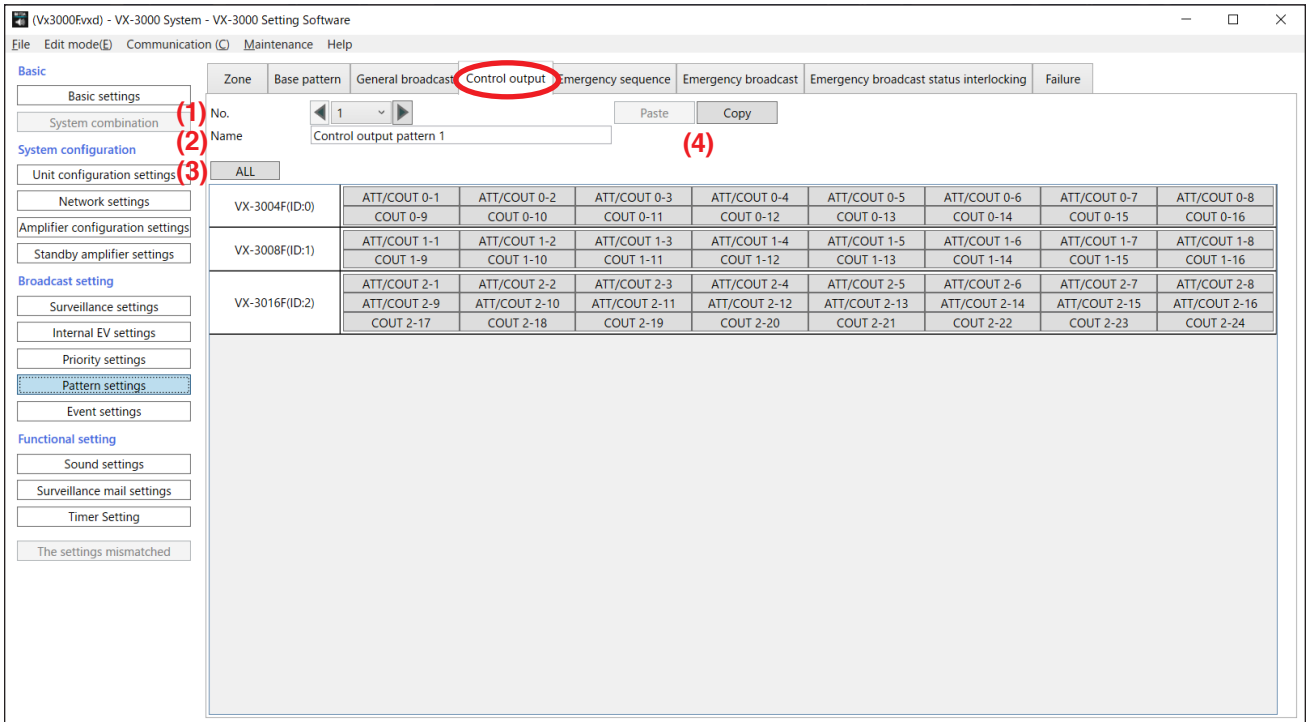
**(1) No.**

Click the box or the arrow buttons to select the control output pattern number.

Available Settings	1 – 1024 (default: 1)
--------------------	-----------------------

**(2) Name**

Enter the name of the control output pattern.

Available Settings	Up to 32 alphanumeric characters (default: Control output pattern 1 – 1024)
--------------------	---

**(3) Control output ON/OFF buttons**

Select the control output terminals to perform control. The cell displayed in a grayout state cannot be selected as the indicated control output is used for attenuator control.

**Tip:** For quick selection of multiple cells, see p. 3-91 "Selecting multiple cells."

Available Settings	On (orange), Off (gray, default)
--------------------	----------------------------------

[When set to "On"]

VX-3004F(ID:0)	ATT/COU 0-1
	COU 0-9

**(4) Copy and Paste buttons**

Clicking the Copy button copies all of the on-screen settings except "Name" (2) preset by default.

Select another control output pattern number. Then, clicking the Paste button pastes the copied parameters in the setting screen of the selected "No." (1).

## 14.6. Emergency Sequence Setting

Clicking the Emergency sequence tab on the pattern settings screen allows emergency sequences to be set.

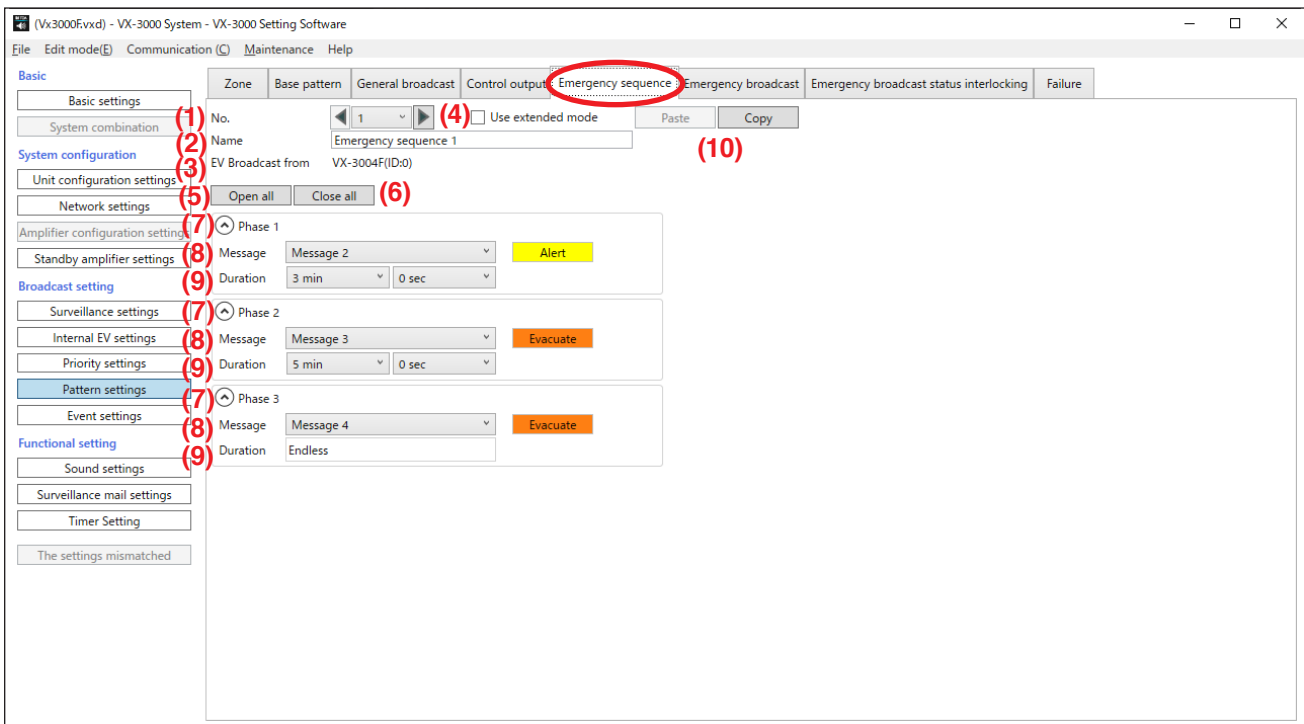

### (1) No.

Click the box or the arrow buttons to select the emergency sequence number.

Available Settings	1 – 32 (default: 1)
--------------------	---------------------

### (2) Name

Enter the name of the emergency sequence.

Available Settings	Up to 32 alphanumeric characters (default: Emergency sequence 1 – 32)
--------------------	---

### (3) EV Broadcast from

Displays the VX-3000F unit that broadcasts the EV message of the emergency sequence.  
Displays the VX-3000F units for each network area when the network area division function is used.

Network area	EV Broadcast from
NetworkArea 0	VX-3004F(ID:0)
NetworkArea 1	VX-3008F(ID:1)
NetworkArea 2	VX-3016F(ID:2)

### (4) Checkbox for "Use extended mode"

If checked, the phases of Emergency sequence can be extended up to 30 levels.

### (5) Open all button

Expands the detailed display of all phases.

### (6) Close all button

Folds the detailed display of all phases.

### (7) Detailed display button

Expands or folds the detailed display for each phase.

### (8) Message

Select the EV message registered in the VX-3000F on the Internal EV setting screen (p. 3-81).  
The selectable EV message type is "Alert" or "Evacuation."  
The selected message type is displayed on the right of the message box.

Available Settings	No sound (default), Set EV messages
--------------------	-------------------------------------

**(9) Duration****[Phase 1 and Phase 2 (Phase 1 through 29 when the extension mode is in use)]**

Select the playback duration of the EV message to be broadcast repeatedly.

Available Settings	min: Endless (default), 0 – 20 [min] sec: 0, 10, 20, 30, 40, 50 [sec] (When "min" is set to "0 min," "sec" cannot be set to "0 sec.")
--------------------	--

**Note**

To register the EV message in Phase 2 and subsequent phases, "Duration" for the preceding phase should be set to a limited time except "Endless."

**[Phase 3 (Phase 30 when the extension mode is in use)]**

Fixed to "Endless," which cannot be changed.

**(10) Copy and Paste buttons**

Clicking the Copy button copies all of the on-screen settings except "Name" (2) preset by default.

Select another emergency sequence number. Then, clicking the Paste button pastes the copied parameters in the setting screen of the selected "No." (1).

**14.7. Emergency Broadcast Pattern Setting**

Clicking the Emergency broadcast tab on the pattern settings screen allows emergency broadcast patterns to be set.

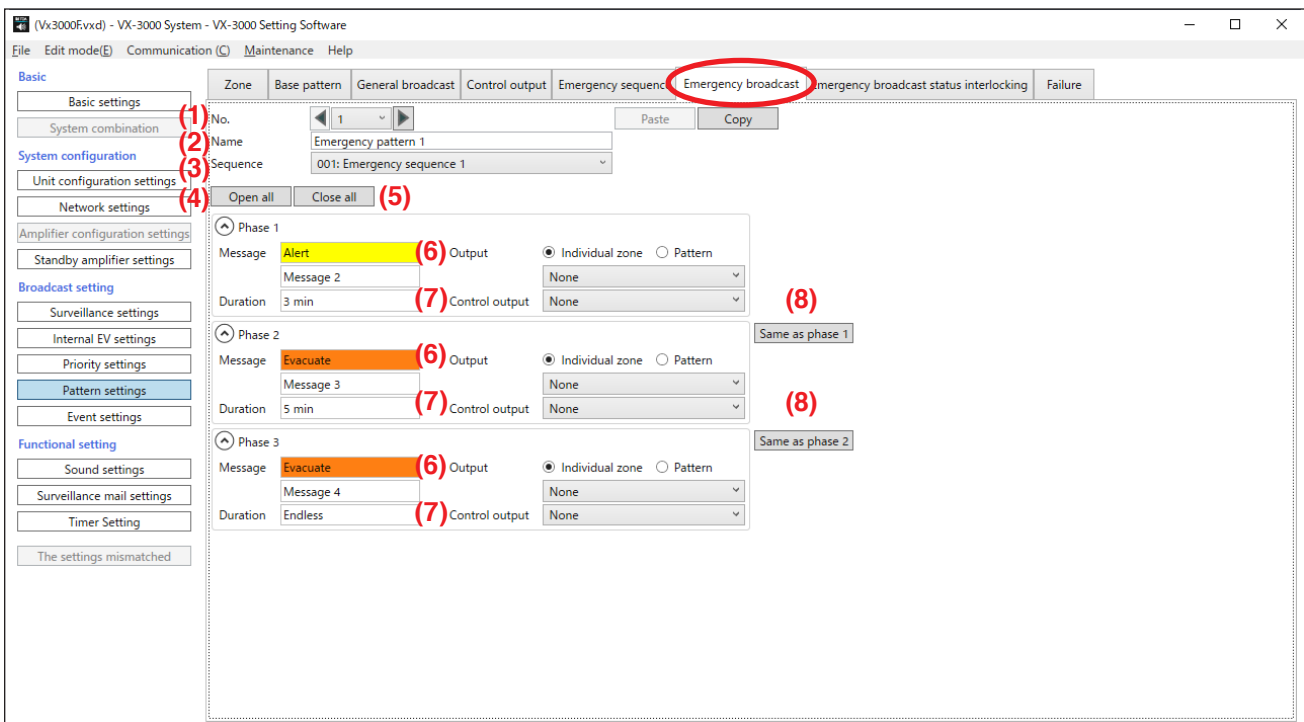
**(1) No.**

Click the box or the arrow buttons to select the emergency broadcast pattern number.

Available Settings	1 – 1024 (default: 1)
--------------------	-----------------------

**(2) Name**

Enter the name of the emergency broadcast pattern.

Available Settings	Up to 32 alphanumeric characters (default: Emergency pattern 1 – 1024)
--------------------	--

**(3) Sequence**

Select the sequence name set in the "Emergency Sequence Settings" (p. 3-101).

Available Settings	None (default), Set Emergency Sequences
--------------------	---

**(4) Open all button**

Expands the detailed display of all phases.

**(5) Close all button**

Folds the detailed display of all phases.

**(6) Output**

Set the output zone of the EV message in each phase status.

Available Settings	Individual zone (default), Pattern
--------------------	------------------------------------

Selecting the "Individual zone" permits the VX-3000F's output zone (Individual) to be selected.

Available Settings	None (default), Output zone (Individual)
--------------------	--

Selecting the "Zone pattern" permits the output zone pattern name set in the "Output Zone Pattern Setting" (p. 3-93) to be selected.

Available Settings	None (default), Output zone (Pattern)
--------------------	---------------------------------------

**Tip**

Only when the pattern is selected, the setting contents of the output zone pattern will be displayed as shown below if you drag the cursor close to the box of the selected pattern. The display is for view only, and no change can be made here.

001: Zone pattern 1									
No.	VX-3004F(ID:0)	ZONE 0-1	ZONE 0-2	ZONE 0-3	ZONE 0-4				
	VX-3008F(ID:1)	ZONE 1-1	ZONE 1-2	ZONE 1-3	ZONE 1-4	ZONE 1-5	ZONE 1-6	ZONE 1-7	ZONE 1-8
	VX-3016F(ID:2)	ZONE 2-1	ZONE 2-2	ZONE 2-3	ZONE 2-4	ZONE 2-5	ZONE 2-6	ZONE 2-7	ZONE 2-8
		ZONE 2-9	ZONE 2-10	ZONE 2-11	ZONE 2-12	ZONE 2-13	ZONE 2-14	ZONE 2-15	ZONE 2-16

**(7) Control output**

Select the control output pattern name set in the "Control Output Pattern Setting" (p. 3-100).

Available Settings	None (default), Control Output Pattern
--------------------	--

**(8) [Same as phase 1] and [Same as phase 2] buttons**

Clicking the [Same as phase 1] button copies the output zone and control output settings set in Phase 1 to those boxes in the Phase 2. Likewise, clicking the [Same as phase 2] button copies the output zone and control output settings set in the Phase 2 to those boxes in the Phase 3.

**(9) Copy and Paste buttons**

Clicking the Copy button copies all of the on-screen settings except "Name" (2) preset by default.

Select another emergency broadcast pattern number. Then, clicking the Paste button pastes the copied parameters in the setting screen of the selected "No." (1).

## 14.8. Control Output Setting Interlocked with the Emergency Broadcast State

Clicking the Emergency broadcast state interlock tab on the pattern setting screen allows the setting of the control output pattern activated in interlock with the VX-3000 system's emergency broadcast state.

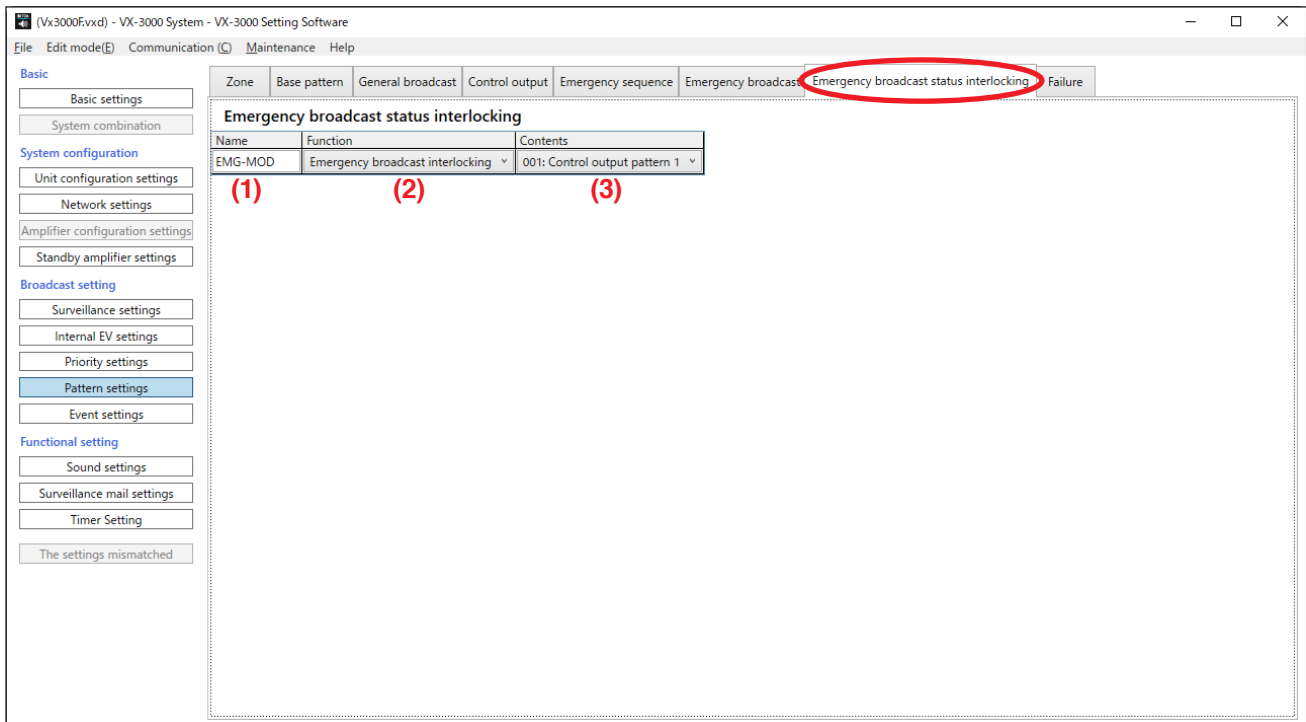

### (1) Name

Enter the name of the emergency broadcast status interlocking pattern.

Available Settings	Up to 32 alphanumeric characters (default: EMG-MOD)
--------------------	---

### (2) Function

Selects the function. If "Emergency broadcast interlocking" is selected, the control output pattern activated in interlock with the VX-3000 system's emergency broadcast state can be set.

Available Settings	None (default), Emergency broadcast interlocking
--------------------	--

### (3) Contents (only when "Function" is set to "Emergency broadcast interlocking")

Selects the control output pattern that operates in interlock with the VX-3000 system's emergency broadcast state.

Select the control output pattern name set in the "Control Output Pattern Setting" (p. 3-100).

Available Settings	None (default), Set control output pattern
--------------------	--

## 14.9. Failure Pattern Setting

Clicking the Failure tab on the pattern settings screen allows failure patterns to be set.

The screenshot shows the 'VX-3000 Setting Software' window with the 'Failure' tab selected. The interface is divided into several sections:

- Basic:** Includes 'System combination' (1), 'Name' (2), and 'System Fault' buttons (3).
- Unit configuration settings:** Includes 'System Fault' buttons for DC Power, VX-LINK, RS-LINK, DS-LINK, and DC-FUSE.
- Amplifier configuration settings:** Includes 'VX unit fault' buttons for VX-3004F(ID:0), VX-3008F(ID:1), and VX-3016F(ID:2).
- Broadcast setting:** Includes 'Surveillance settings', 'Internal EV settings', 'Priority settings', and 'Pattern settings' (4).
- Functional setting:** Includes 'Sound settings' and 'Surveillance mail settings'.
- Timer Setting:** (4) Includes 'The settings mismatched' button.
- Control input:** (5) Includes a table for 'Control input' with columns for various units and channels.
- External fault:** (6) Includes a table for 'External fault' with columns for ID, Terminal number, and unit name.
- Failure status output:** (7) Includes 'Control method' and 'Failure status output to'.
- Send mail settings:** (8) Includes 'Mail destination' and 'None'.

Settings made here are operatively associated with the p. 3-77 "SURVEILLANCE SETTINGS." Select the units or the surveillance target points.

### • Selecting the units (Designate the units as factors to activate failure pattern.)

At least one or more surveillance points must be set to the unit to be selected here to enable surveillance function.

This failure pattern is activated when irregularity is detected at the surveillance points of the selected unit. Set the operation of the unit when the set failure patterns are activated in the "Event settings (p. 3-108)." Characters on each setting button on the screen represent the unit names as shown below.

ID: 0	VX-3000F with ID "0"
VX0-RM0	Remote microphone with ID "0" connected to the VX-3000F with ID "0"
Ch 1	Power amplifier installed in the VX-3000F's slot 1
ZONE 0-1	SP OUTPUT 1 of the VX-3000F with ID "0"

• **Selecting the surveillance target points (Designate the surveillance target points as factors to activate failure pattern.)**

Each setting button in the "System failure" becomes active when the following surveillance points are marked in any one of the units within the system in the "Surveillance settings (p. 3-77)."

This failure pattern is activated when irregularity is detected at the selected surveillance points set to any one of the VX-3000F within the system.

Set the operation of the unit when the set failure patterns are activated in the "Event settings (p. 3-108)."

Each setting button on the screen represents the surveillance points as shown below.

DC POWER	DC power of the VX-3000F
VX LINK	VX link of the VX-3000F
RS LINK	RS link of the remote microphone connected to the VX-3000F
DS LINK	DS link of the VX-3000F
DC FUSE	Fuse of the VX-015DA, VX-030DA and VX-050DA

**(1) No.**

Click the box or the arrow buttons to select the failure pattern number.

Available Settings	1 – 1024 (default: 1)
--------------------	-----------------------

**(2) Name**

Enter the name of the failure pattern.

Available Settings	Up to 32 alphanumeric characters (default: Failure pattern 1 – 1024)
--------------------	--

**(3) Failure detection units or surveillance target points settings**

Select the units or surveillance target points as factors to activate failure patterns.

**Tip:** For quick selection of multiple cells, see p. 3-91, "Selecting multiple cells."

Available Settings	On (orange), Off (gray, default)
--------------------	----------------------------------

**[When set to "On"]**

VX-3004F(ID:0)	Ch.1
----------------	------

**(4) Speaker line fault**

- Select which failure in the speaker line is targeted in "Type."

Available Settings	Open & Short & Earth (default), Open & Short, Short & Earth, Open & Earth, Open only, Short only, Earth only
--------------------	--

- Select the target zone.

Available Settings	On (orange), Off (gray, default)
--------------------	----------------------------------

**Notes**

- When the unit is the VX-3008F or VX-3016F, "Earth" allows all zones including the extension units' zones to be targeted for surveillance failure detection. That is, when the target zone is selected with "Earth" included in "Type" (Speaker line fault type in the screen on p. 3-105), all zones including the extension units' zones are selected.
- The zone assigned for the VX-300LO cannot be selected.

**Tip**

For quick selection of multiple cells, see p. 3-91, "Selecting multiple cells."

**(5) Control input**

Select the target control inputs.

Available Settings	On (orange), Off (gray, default)
--------------------	----------------------------------

**(6) External fault**

This function is available when the "External failure input" is set to the control input terminals of the VX-3000F. Up to 4 External failure inputs can be set.

**Note**

Use the Event of each unit in the "Event Settings" (p. 3-108) to set the function to the control input terminals. For details, see p. 3-126.

Available Settings	None (default), External failure input terminals set in the "Event Settings"
--------------------	--

**(7) Failure status output****• Control method**

Select the control method of the failure control output.

Available Settings	Normal (default), Invert
--------------------	--------------------------

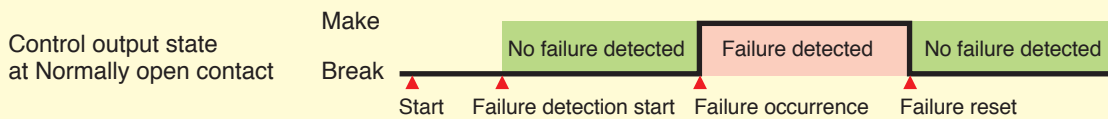
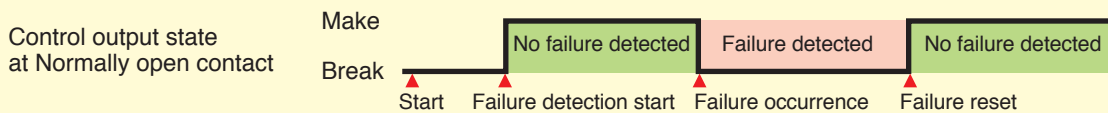
**[Operation image of the control output when the Control method is set to "Normal"]****[Operation image of the control output when the Control method is set to "Invert"]****• Failure output status to**

Set the control output pattern to be output when the set failure pattern has occurred. This setting item is valid when at least one surveillance target point is selected in the item (3).

Available Settings	None (default), Set control output patterns
--------------------	---

**(8) Send mail settings**

When wishing to send an e-mail notification at the time of failure occurrence and failure reset, set the transmission destination.

Register the destination e-mail addresses on the Surveillance mail settings screen (p. 3-158) in advance. And register addresses in mailing list as needed.

First, select "Individual" or "Mailing list" for the addresses to be set.

Available Settings	Individual (default), Mailing list
--------------------	------------------------------------

When "Individual" is selected, the individual e-mail address registered in the "Basic settings" (p. 3-38) of the "Surveillance mail settings" can be selected.

Available Settings	None (default), Registered Mail address
--------------------	---

When "Mailing list" is selected, the name of the mailing list in the "Mailing list" (p. 3-160) of the "Surveillance mail settings" can be selected.

Available Settings	None (default), The name of the mailing list
--------------------	--

**(9) Copy and Paste buttons**

Clicking the Copy button copies all of the on-screen settings except "Name" (2) preset by default.

Select another failure pattern number. Then, clicking the Paste button pastes the copied parameters in the setting screen of the selected "No." (1).

## 15. EVENT SETTINGS

Clicking the Event settings button displays the screen below.

Assign functions to the control input terminals of the VX-3000F, the function keys of the remote microphones, and the fault indicators of the VX-3000F.

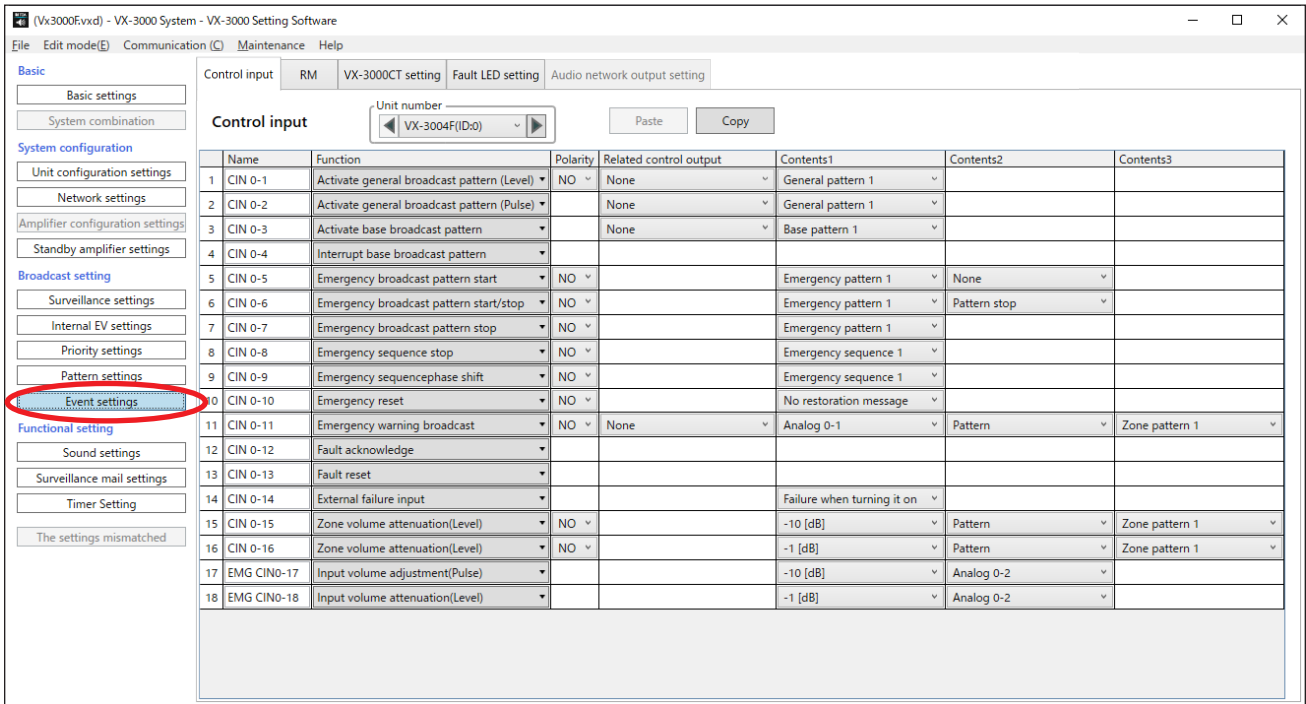

### 15.1. Assignable Functions and Explanations

#### 15.1.1. VX-3000F and the remote microphone

Function	Assigned to	Control input terminals		Function keys or Talk key		Reference page
		VX-3000F	VX-3000PM	RM-200SF, RM-320F, RM-300X, RM-210F		
				When "Type" is set to "Emergency" or "Emergency/General"	When "Type" is set to "General"	
Activate general broadcast pattern				✓	✓	p. 3-113
General broadcast pattern	Activate general broadcast pattern (Level)	✓	✓			p. 3-113
	Activate general broadcast pattern (Pulse)	✓	✓			p. 3-114
Base pattern	Activate base broadcast pattern	✓	✓	✓	✓	p. 3-115
	Interrupt base broadcast pattern	✓	✓	✓	✓	p. 3-115
Volume adjustment	Zone volume adjustment (Pulse)	✓	✓	✓	✓	p. 3-117
	Zone volume attenuation (Level)	✓	✓			p. 3-117
	Input volume adjustment (Pulse)*1	✓	✓	✓	✓	-
	Input volume attenuation (Level)*1	✓	✓			-

\*1 The input channel of which audio source type is set to "Emergency warning" cannot be set as the channel available for these functions.

Assigned to		Control input terminals		Function keys or Talk key		Reference page
		VX-3000F	VX-3000PM	RM-200SF, RM-320F, RM-300X, RM-210F	When "Type" is set to "Emergency" or "Emergency/General"	
Function						
Time adjustment		✓	✓			p. 3-117
Emergency	Emergency broadcast pattern start* <sup>2</sup>	✓		✓		p. 3-118
	Emergency broadcast pattern stop* <sup>2</sup>	✓		✓		p. 3-118
	Emergency broadcast pattern start/stop* <sup>2</sup>	✓		✓		p. 3-118
	Emergency sequence stop* <sup>2</sup>	✓		✓		p. 3-118
	Emergency sequence phase shift* <sup>2</sup>	✓		✓		p. 3-118
	Emergency reset* <sup>2</sup>	✓		✓		p. 3-118
	Emergency broadcast silence* <sup>2</sup>	✓		✓		p. 3-121
	Emergency EV broadcast* <sup>2</sup>			✓		–
	Emergency acknowledge* <sup>2</sup>			✓		–
Emergency warning broadcast		✓	✓	✓	✓	p. 3-116
Activate general/BGM broadcast				✓	✓	p. 3-124
Malfunction	Fault acknowledge* <sup>3</sup>	✓		✓	✓	–
	Fault reset* <sup>3</sup>	✓		✓	✓	–
	External failure input* <sup>3</sup>	✓				p. 3-122
Pre select	Pre select (Pattern)			✓	✓	–
	Pre select (Individual)			✓	✓	–
	Clear pre selected zones			✓	✓	–
Intended Control in/out	Intended control input operation			✓	✓	–
	Intended control output operation (Pulse)			✓	✓	–
	Intended control output operation (Level)			✓	✓	–
Maintenance	RM broadcast status			✓	✓	p. 3-123
	Audio Monitor			✓	✓	–
	Disablement of EMG control from CIN* <sup>2</sup>			✓		–
	Lamp test			✓	✓	–
Power on (Level)* <sup>4</sup>		✓	✓			p. 3-125
Power on (Pulse)* <sup>4</sup>		✓	✓			p. 3-125
Power on* <sup>4</sup>				✓	✓	p. 3-125
TALK					✓	–
Emergency TALK				✓		
General TALK				✓		–

\*<sup>2</sup> These functions are available for the control input terminals and remote microphones when the emergency broadcast function is set to "Used" in the "Basic settings."

In addition to this setting, for the remote microphones, these functions are available when its type is set to "Emergency" or "Emergency/General" in the "Unit configuration settings."

\*<sup>3</sup> These functions are available when the surveillance function is set to "Used" in the "Basic settings."

\*<sup>4</sup> These functions are available when the sleep mode is set to "Used" in the "Basic settings."

Function	Contents
Activate general broadcast pattern	Activates general-purpose pattern broadcasts using the function key. (See <a href="#">p. 3-113.</a> )
Activate general broadcast pattern (Level)	Activates general-purpose pattern broadcasts using the control input (Level). (See <a href="#">p. 3-113.</a> )
Activate general broadcast pattern (Pulse)	Activates general-purpose pattern broadcasts using the control input (Pulse). (See <a href="#">p. 3-114.</a> )
Activate base broadcast pattern	Activates base pattern broadcast using the function key or control input. (See <a href="#">p. 3-115.</a> )
Interrupt base broadcast pattern	Ends base pattern broadcast using the function key or control input. (See <a href="#">p. 3-115.</a> )
Zone volume adjustment (Pulse)	Adjusts the volume level of the zone output pattern using the function key or the control input (Pulse). (See <a href="#">p. 3-117.</a> )
Zone volume attenuation (Level)	Decreases the volume level of the zone output pattern using the control input (Level). (See <a href="#">p. 3-117.</a> )
Input volume adjustment (Pulse)	Adjusts the input volume level using the function key or the control input (Pulse).
Input volume attenuation (Level)	Decreases the input volume level using the control input (Level).
Time adjustment	Zero-adjusts the VX-3000F's internal clock. (See <a href="#">p. 3-117.</a> )
Emergency broadcast pattern start	Activates the emergency broadcast pattern using the function key or control input. (See <a href="#">p. 3-118.</a> )
Emergency broadcast pattern stop	Stops the activated emergency broadcast pattern using the function key or control input. (See <a href="#">p. 3-118.</a> )
Emergency broadcast pattern start /stop	Activates stops the activated emergency broadcast pattern using the function key or control input. (See <a href="#">p. 3-118.</a> )
Emergency sequence stop	Stops the activated all emergency broadcast patterns which include the designated emergency sequence using the function key or control input. (See <a href="#">p. 3-118.</a> )
Emergency sequence phase shift	Shifts the phase in progress to the next phase in the emergency broadcast pattern's sequence using the function key or control input. (See <a href="#">p. 3-118.</a> )
Emergency reset	Terminates the emergency broadcast state using the function key or control input, and returns the system to the normal state. (See <a href="#">p. 3-118.</a> )
Emergency broadcast silence	Prevents the EV sound sources of which audio source type is set to "Evacuate" or "Alert" from being played back using the function key or control input. (See <a href="#">p. 3-121.</a> )
Emergency EV broadcast	Plays back the EV sound sources of which audio source type is set to "Evacuate" or "Alert" using the function key.
Emergency acknowledge	Stops the buzzer sounding at the time of emergency activation using the function key.
Disablement of EMG control from CIN	Stops the emergency activation from the control input using the function key only while the system is in general mode. This function is useful at maintenance work.
Emergency warning broadcast	Activates the emergency warning broadcast using the function key or control input. (See <a href="#">p. 3-116.</a> )
Fault acknowledge	Receives the activated failure output pattern using the function key or control input. When this function is assigned to the control input, any activated failure pattern in the system can be acknowledged by the control input, while when assigned to the function key, only the activated specific failure pattern can be acknowledged by the function key. (See the separate Operating Instructions, "Operation.")
Fault reset	Resets all fault state in the system using the function key or control input. (See the separate Operating Instructions, "Operation.")
External failure input	Accepts an external failure state. (See <a href="#">p. 3-122.</a> )
RM broadcast status	Displays the current broadcast status of other remote microphone(s) on the indicator of the function key. (See <a href="#">p. 3-123.</a> )

Function	Contents
Activate general/BGM broadcast	Broadcasts the EV sound source and the audio signals from the VX-3000F's/VX-3000PM's Audio input and remote microphone's AUX input to the selected zones using the function key. (See p. 3-124.)
Pre select (Pattern)	Selects the general broadcast zones using the patterns. (See the separate Operating Instructions, "Operation.")
Pre select (Individual)	Selects each VX-3000F's speaker output through which general broadcasts are output.
Clear pre selected zones	Resets zones being selected by the remote microphone.
Lamp test	Performs the lamp test of the RM-200SF's or RM-300X's indicators.
Audio Monitor	Selects the audio signals to monitor with the remote microphone's monitor speaker using the function key.
Intended control input operation	Controls the VX-3000F's control input state using the function key.
Intended control output operation (Pulse)	Controls the VX-3000F's control output state using the function key (Pulse).
Intended control output operation (Level)	Controls the VX-3000F's control output state using the function key (Level).
Power on (Level)	Turns ON the VX-3000F's amplifier power using the control input (Level) when in sleep mode. (See p. 3-125.)
Power on (Pulse)	Switches the VX-3000F's amplifier power state between active (ON) and sleep modes using the control input (Pulse). (See p. 3-125.)
Power on	Switches the VX-3000F's amplifier power state between active (ON) and sleep modes using the function key. (See p. 3-125.)
TALK	Broadcasts to the selected zones using the Talk key. It is also possible to broadcast to the specified zones if no zones are selected.

### 15.1.2. VX-3000CT

Function	Assigned to	Volume control	Function key	Reference page
Input volume attenuation		✓		–
Output volume attenuation		✓		–
Activate general broadcast pattern			✓	p. 3-113
Base pattern	Activate base broadcast pattern		✓	p. 3-115
	Interrupt base broadcast pattern		✓	p. 3-115
Volume adjustment	Zone volume adjustment (Pulse)		✓	p. 3-117
	Input volume adjustment (Pulse)*1		✓	–
Emergency warning broadcast			✓	p. 3-116
Activate general/BGM broadcast			✓	p. 3-124
Pre select	Pre select (Pattern)		✓	–
	Pre select (Individual)		✓	–
	Clear pre selected zones		✓	–
Intended Control in/out	Intended control input operation		✓	–
	Intended control output operation (Pulse)		✓	–
	Intended control output operation (Level)		✓	–
Power on*2			✓	p. 3-125

\*1 The input channel of which audio source type is set to "Emergency warning" cannot be set as the channel available for this function.

\*2 This functions is available when the sleep mode is set to "Used" in the "Basic settings."

Function	Contents
Input volume adjustment	Adjusts the input volume level using the Volume control knob.
Output volume adjustment	Adjusts the volume level of the output zone or the zone output pattern using the Volume control knob.
Activate general broadcast pattern	Activates general-purpose pattern broadcasts using the function key. (See <a href="#">p. 3-113.</a> )
Activate base broadcast pattern	Activates base pattern broadcast using the function key. (See <a href="#">p. 3-115.</a> )
Interrupt base broadcast pattern	Ends base pattern broadcast using the function key. (See <a href="#">p. 3-115.</a> )
Zone volume adjustment (Pulse)	Adjusts the volume level of the zone output pattern using the function key. (See <a href="#">p. 3-117.</a> )
Input volume adjustment (Pulse)	Adjusts the input volume level using the function key.
Emergency warning broadcast	Activates the emergency warning broadcast using the function key. (See <a href="#">p. 3-116.</a> )
Activate general/BGM broadcast	Broadcasts the EV sound source and the audio signals from the VX-3000F's/VX-3000PM's Audio input and remote microphone's AUX input to the selected zones using the function key. (See <a href="#">p. 3-124.</a> )
Pre select (Pattern)	Selects the general broadcast zones using the patterns. (See the separate Operating Instructions, "Operation.")
Pre select (Individual)	Selects each VX-3000F's speaker output through which general broadcasts are output.
Clear pre selected zones	Resets zones being selected by the VX-3000CT.
Intended control input operation	Controls the VX-3000F's control input state using the function key.
Intended control output operation (Pulse)	Controls the VX-3000F's control output state using the function key (Pulse).
Intended control output operation (Level)	Controls the VX-3000F's control output state using the function key (Level).
Power on	Switches the VX-3000F's amplifier power state between active (ON) and sleep modes using the function key. (See <a href="#">p. 3-125.</a> )

## 15.2. Function Description

### 15.2.1. "Activate general broadcast pattern," "Activate general broadcast pattern (Level)"

When different control inputs\* turn ON, general-purpose pattern broadcasts activated by each control input are made simultaneously.

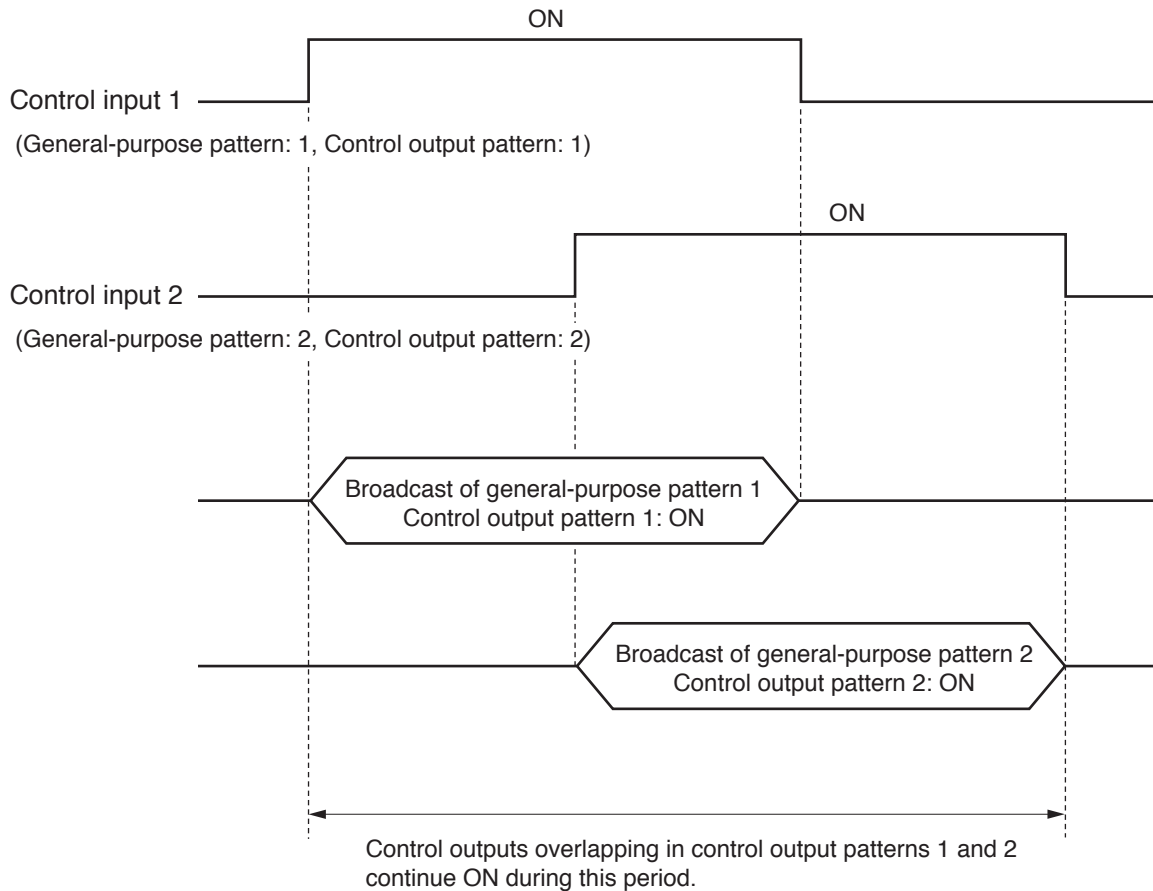

General-purpose patterns and control output patterns in the above example operate as follows:

- Example of general-purpose pattern operation  
General-purpose pattern 1 activated when control input 1 is ON continues until control input 1 turns OFF.  
General-purpose pattern 2 activated when control input 2 is ON continues until control input 2 turns OFF.
- Example of control output operation  
Control output pattern 1 activated when control input 1 is ON continues until control input 1 turns OFF.  
Control output pattern 2 activated when control input 2 is ON continues until control input 2 turns OFF.  
The state of control outputs overlapping in control output patterns 1 and 2 continues during the period from the time control input 1 turns ON until control input 2 turns OFF. (OR logic output)

\* This timing chart also applies when general-purpose pattern broadcasts are activated by the function keys of the RM-200SF, RM-320F, RM-300X, RM-210F, or VX-3000CT.

### 15.2.2. Activate general broadcast pattern (Pulse)

When different control inputs turn ON, general-purpose pattern broadcasts activated by each control input are made simultaneously.

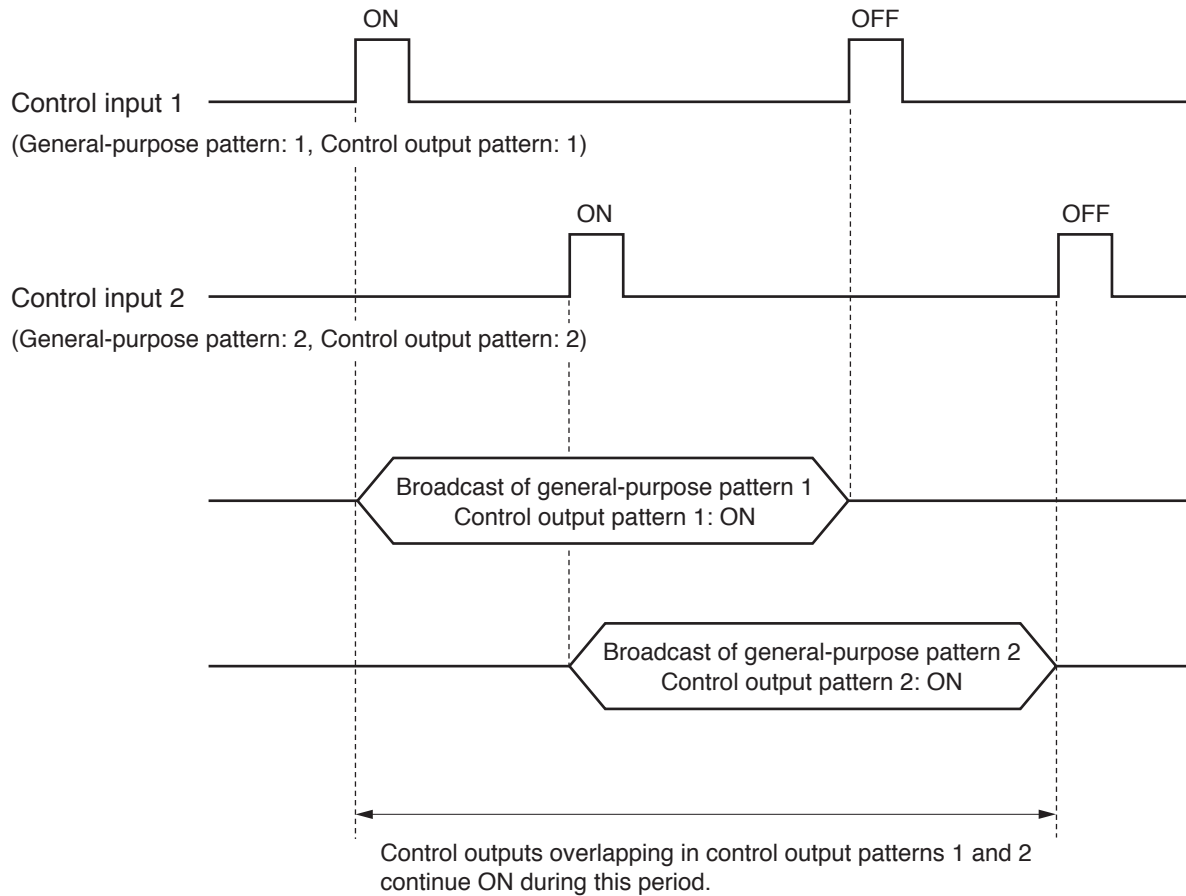

General-purpose patterns and control output patterns in the above example operate as follows:

- Example of general-purpose pattern operation  
General-purpose pattern 1 activated when control input 1 is ON continues until control input 1 turns OFF.  
General-purpose pattern 2 activated when control input 2 is ON continues until control input 2 turns OFF.
- Example of control output operation  
Control output pattern 1 activated when control input 1 is ON continues until control input 1 turns OFF.  
Control output pattern 2 activated when control input 2 is ON continues until control input 2 turns OFF.  
The state of control outputs overlapping in control output patterns 1 and 2 continues during the period from the time control input 1 turns ON until control input 2 turns OFF. (OR logic output)

### 15.2.3. Activate/Interrupt base broadcast pattern

Base pattern broadcasts can be switched by control input\*.

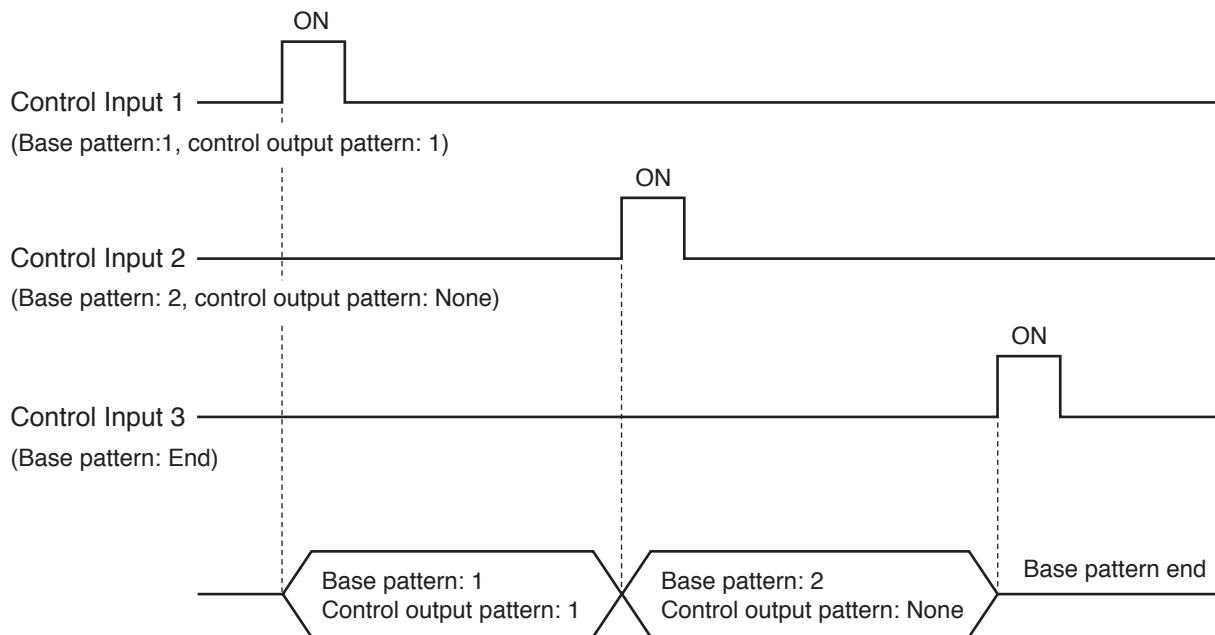

Operation of the base pattern and the control output pattern in the above example is as follows:

- Example of base pattern operation  
Base pattern 1 activated by Control Input 1 is switched to base pattern 2 by Control Input 2.
- Example of control output operation  
The state of the control output (control output assigned by Control Output Pattern 1) activated by Control Input 1 is turned OFF by "Control output pattern: None" activated by Control Input 2.
- \* The timing chart also applies when base pattern broadcasts are changed by the function keys of the RM-200SF, RM-320F, RM-300X, RM-210F, or VX-3000CT.

### 15.2.4. "Emergency warning broadcast"

When different control inputs\* turn ON, Emergency warning broadcasts activated by each control input are made simultaneously.

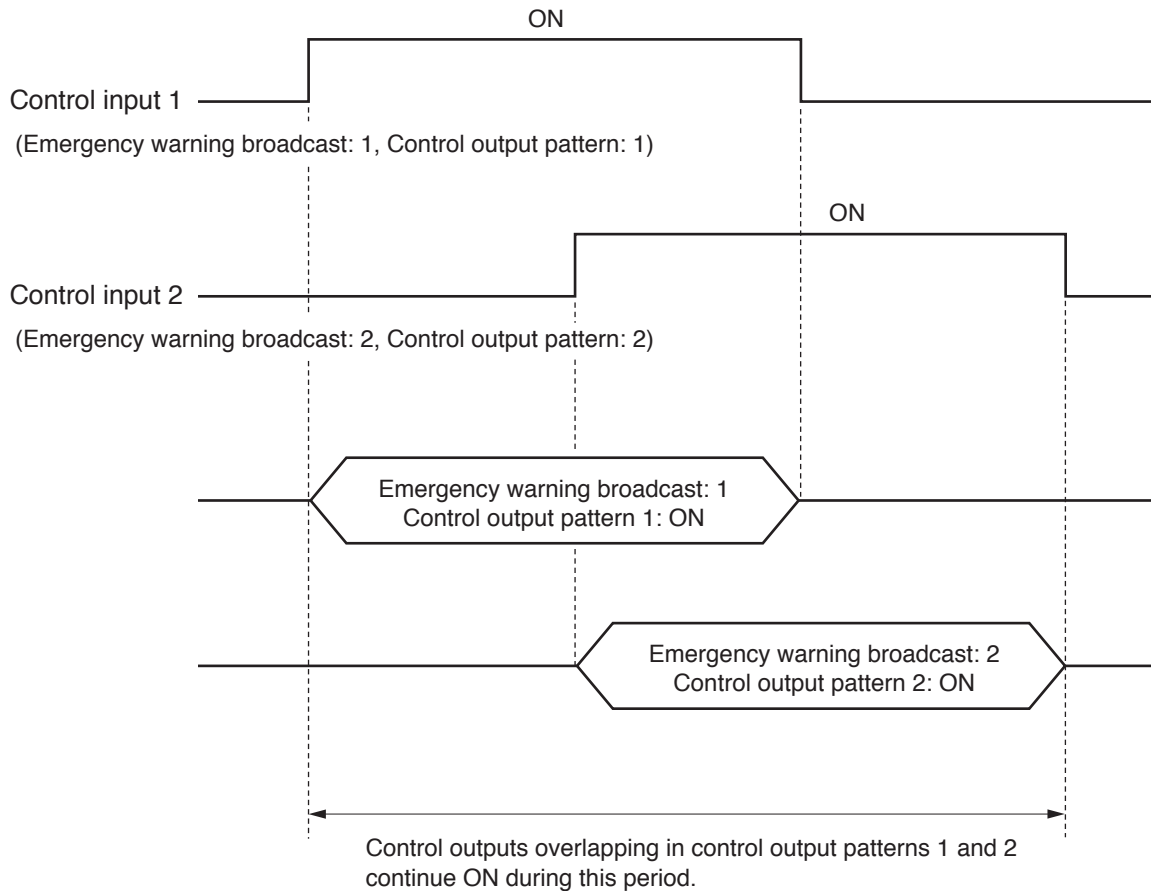

Emergency warning broadcasts and control output patterns in the above example operate as follows:

- Example of Emergency warning broadcasts operation  
Emergency warning broadcast 1 activated when control input 1 is ON continues until control input 1 turns OFF.  
Emergency warning broadcast 2 activated when control input 2 is ON continues until control input 2 turns OFF.
- Example of control output operation  
Control output pattern 1 activated when control input 1 is ON continues until control input 1 turns OFF.  
Control output pattern 2 activated when control input 2 is ON continues until control input 2 turns OFF.  
The state of control outputs overlapping in control output patterns 1 and 2 continues during the period from the time control input 1 turns ON until control input 2 turns OFF. (OR logic output)
- \* This timing chart also applies when Emergency warning broadcasts are activated by the function keys of the RM-200SF, RM-320F, RM-300X, RM-210F, or VX-3000CT.

### 15.2.5. Control signal for adjusting volume

This function changes the volume of broadcasts currently in progress.

Either a pulse or level signal can be selected as the signal to change the volume.

Pulse signal: Each time the control input is turned ON, the volume increases or decreases by the set amount.

Level signal: While the control terminal is ON, the volume is attenuated by the set amount. After the control input is turned OFF, the volume returns to the original level.

#### • Example of Pulse signal-operated volume change

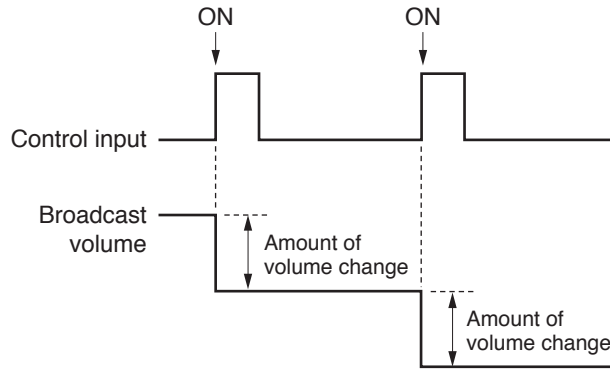

#### • Example of Level signal-operated volume change

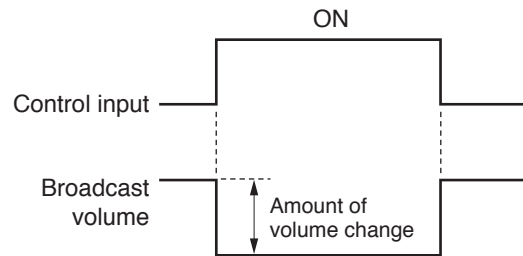

### 15.2.6. Time adjustment

This function permits the system to receive time correction signal from a master or wave clock to correct the system's time in  $\pm 30$  seconds units.

The time correction is performed by the timing of a pulse rising edge.

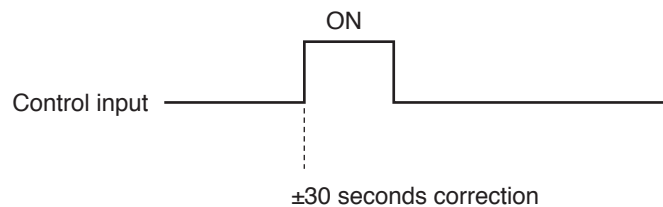

Time is corrected as follows:

- When time is from 0 to 29 seconds, it is corrected to 0 second.  
(Example) When the VX-3000F's time is 07:15:15, it is corrected to 07:15:00.
- When time is from 30 to 59 seconds, it is corrected to +1 minute, 0 second.  
(Example) When the VX-3000F's time is 07:15:45, it is corrected to 07:16:00.

### 15.2.7. Emergency broadcast

Emergency broadcast pattern can be started or stopped, sequence phase can be shifted within the pattern, and emergency broadcast status can be reset to normal broadcast status via control input.

#### [Setting Example]

Perform settings for each item as follows in advance.

#### • EV message settings

EV message No.	1	2	3	4	5
EV message name	EV1	EV2	EV3	EV4	EV5
Type	Alert	Evacuation	Alert	Evacuation	Restoration

#### • Emergency sequence settings

Emergency sequence 1	Phase 1	Phase 2	Phase 3
	EV1, 5-minute broadcast	EV2, Continuous broadcast	—
Emergency sequence 2	Phase 1	Phase 2	Phase 3
	EV3, 5-minute broadcast	EV4, Continuous broadcast	—

**Note:** Phase 3 is not set in this example.

#### • Emergency broadcast pattern settings

Emergency broadcast pattern 1	Emergency sequence 1	Phase 1	Phase 2	Phase 3
	Output zone	EV1, 5-minute broadcast	EV2, Continuous broadcast	—
	Control output pattern	Output zone pattern 1	Output zone pattern 2	—
Emergency broadcast pattern 2	Emergency sequence 2	Phase 1	Phase 2	Phase 3
	Output zone	EV3, 5-minute broadcast	EV4, Continuous broadcast	—
	Control output pattern	Output zone pattern 3	Output zone pattern 4	—
Emergency broadcast pattern 3	Emergency sequence 1	Phase 1	Phase 2	Phase 3
	Output zone	EV1, 5-minute broadcast	EV2, Continuous broadcast	—
	Control output pattern	Output zone pattern 5	Output zone pattern 6	—

#### • Control input settings

- Control input 1: Activate Emergency broadcast pattern 1
- Control input 2: Activate Emergency broadcast pattern 2
- Control input 3: Activate Emergency broadcast pattern 3
- Control input 4: Interrupt Emergency broadcast pattern 1
- Control input 5: Emergency sequence 1 phase shift
- Control input 6: Interrupt Emergency sequence 1
- Control input 7: Emergency reset (EV5 playback)

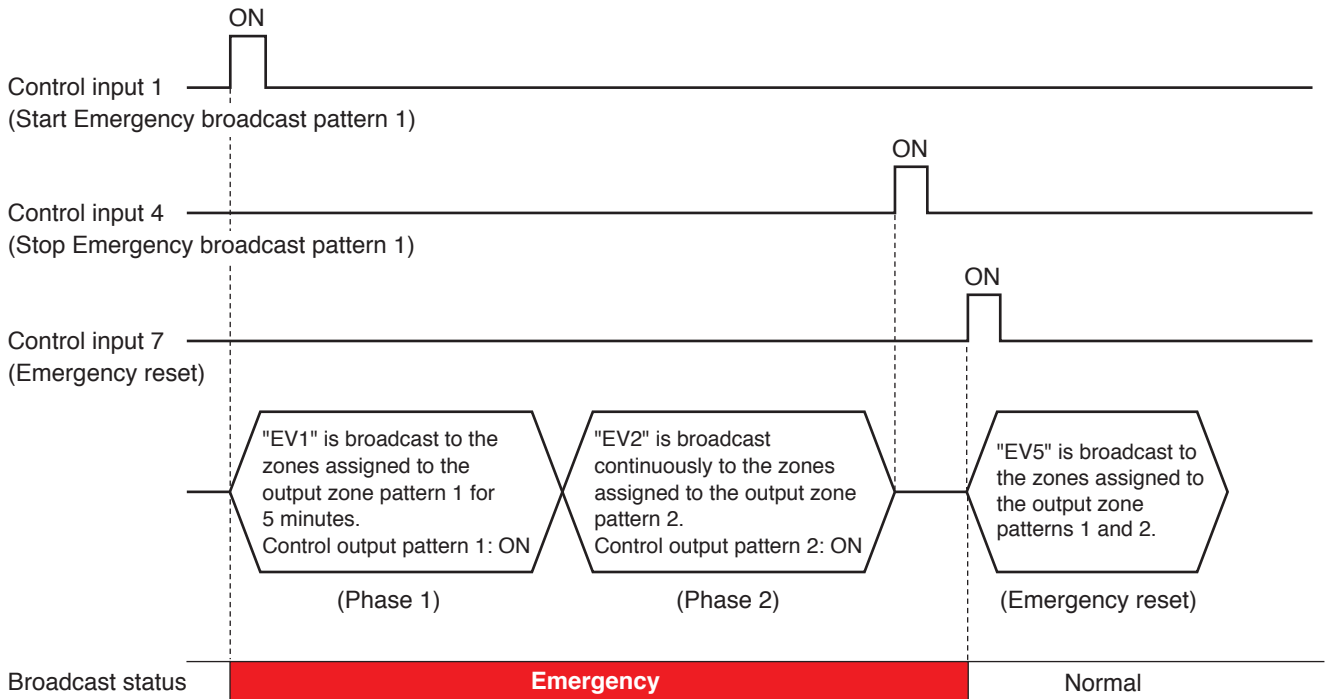
**[Operation example 1]**

Operations in this example are as follows:

- Phase 1 automatically shifts to Phase 2 when the preset time has elapsed.
- EV message "EV2" set to "Continuous broadcast" stops with the control input 4 ("Stop Emergency broadcast pattern 1" signal) or the control input 7 ("Emergency reset" signal).
- Emergency broadcast status continues even if the emergency broadcast pattern stops. After the broadcast status has returned to Normal mode, the Restoration EV message will be broadcast. ("Emergency reset" signal).

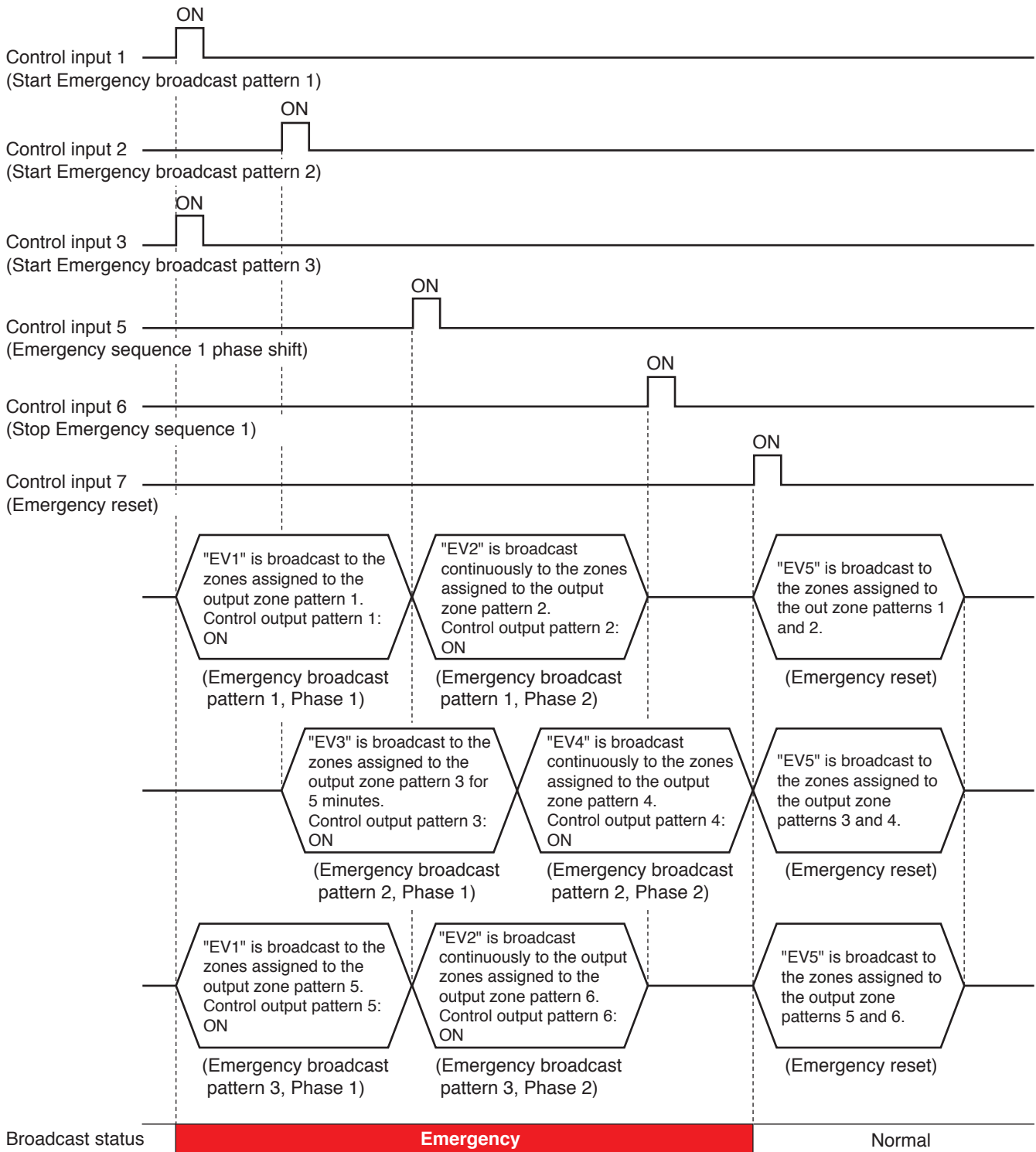
**[Operation example 2]****Note**

When the zone output patterns in the phases of both emergency broadcast patterns 1, 2, and 3 include the same zone(s), the emergency broadcast pattern with higher-priority EV message has precedence if both broadcasts to the same zone(s) overlap.

Operations in this example are as follows:

- Phase 1 shifts to Phase 2 with the control input 5 ("Emergency sequence 1 phase shift" signal) before the Phase 1 broadcast ends.
- All emergency broadcast patterns including the same Emergency sequence 1 stop with the control input 6 ("Interrupt Emergency sequence 1" signal).
- All emergency broadcast patterns stop with the control input 7 ("Emergency reset" signal). After the broadcast status has returned to Normal mode, the Restoration EV message will be broadcast.

### 15.2.8. Emergency broadcast silence

This function mutes the output of the EV sound source of which audio source type is set to "Evacuate" or "Alert." Setting the Emergency broadcast silence function to ON when in emergency mode causes all EV sound source outputs set to "Evacuate" or "Alert" in the VX-3000 system to be muted while the emergency mode is being kept. Even if the Emergency broadcast silence function is ON, the emergency broadcast and the emergency warning broadcast can be made using the microphone. The emergency broadcast pattern can also be activated. As the emergency mode is being maintained, the phase shift will be executed inside the unit when the preset period of time elapses. With this setting, general broadcast is disabled.

Turning the Emergency broadcast silence function to OFF from ON causes the Emergency EV broadcast to be started again.

#### Note

This function is enabled only while the emergency broadcast is in progress.

When the emergency mode is reset, the emergency broadcast silence function becomes inactive.

#### [When the emergency broadcast silence function is turned ON or OFF by the control input]

When the control input polarity is set to "NO": This function becomes active while the control input is closed and inactive when it is open.

When the control input polarity is set to "NC": This function becomes active while the control input is open and inactive when it is closed.

#### [When the emergency broadcast silence function is turned ON or OFF using the remote microphone's key]

The function ON/OFF operation can be set to the function key of the remote microphone of which type is set to "Emergency" or "Emergency/General."

When the emergency broadcast silence function is set to OFF, pressing this function key turns the function ON. Then, pressing this key again turns the function OFF.

#### [Setting Example]

Perform settings for each item as follows in advance.

##### • EV message settings

EV message No.	1	2	3
EV message name	EV1	EV2	EV3
Type	Alert	Evacuation	Restoration

##### • Emergency sequence settings

Emergency sequence 1	Phase 1	Phase 2	Phase 3
	EV1, 5-minute broadcast	EV2, Continuous broadcast	—

**Note:** Phase 3 is not set in this example.

##### • Emergency broadcast pattern settings

Emergency broadcast pattern 1	Emergency sequence 1	Phase 1	Phase 2	Phase 3
		EV1, 5-minute broadcast	EV2, Continuous broadcast	—
	Output zone	Output zone pattern 1	Output zone pattern 2	—
	Control output pattern	Control output pattern 1	Control output pattern 2	—

##### • Control input settings

Control input 1: Activate Emergency broadcast pattern 1

Control input 2: Emergency reset (EV3 playback)

Control input 3: Emergency broadcast silence

**[Operation example]**

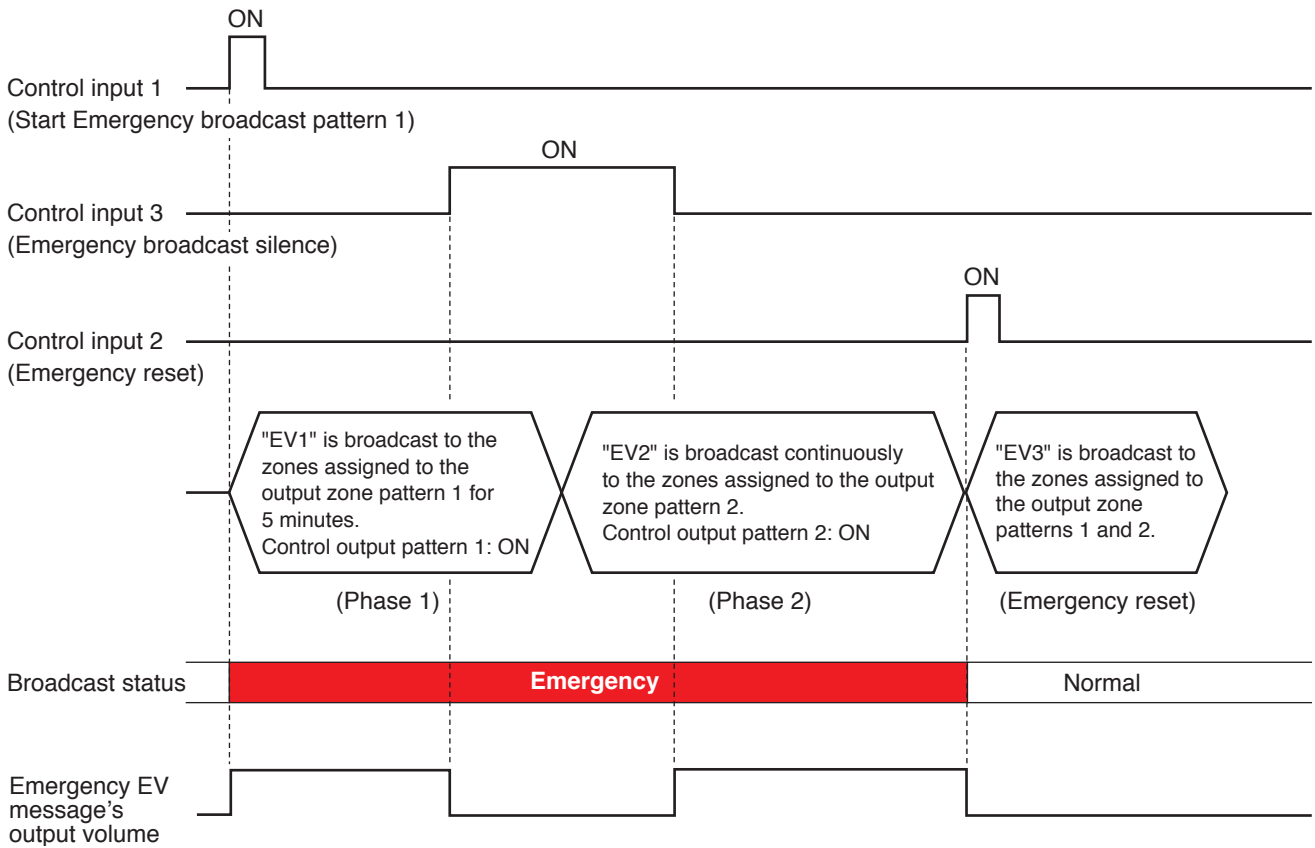

**15.2.9. External failure input**

Failure status of the external equipment can be accepted. Match the settings of the external failure input with type of a failure signal from the external equipment to "make" (close) or "break" (open). The failure pattern to which the external failure input is assigned is activated when an external failure signal is input.

**[Example when being "make" at the time of external equipment's failure]**

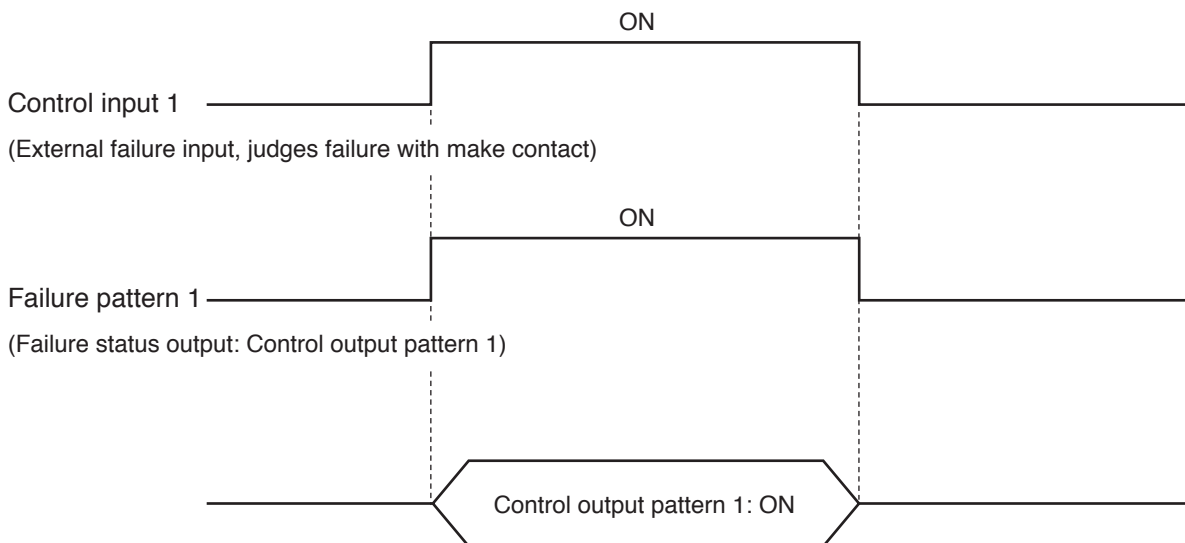

**Note**

As for which conditions lead the external device into fault status, see the manual enclosed with that device.

### 15.2.10. RM broadcast status

This function displays the current broadcast status of other remote microphones on the function key of the enabled remote microphone.

#### [Operation example]

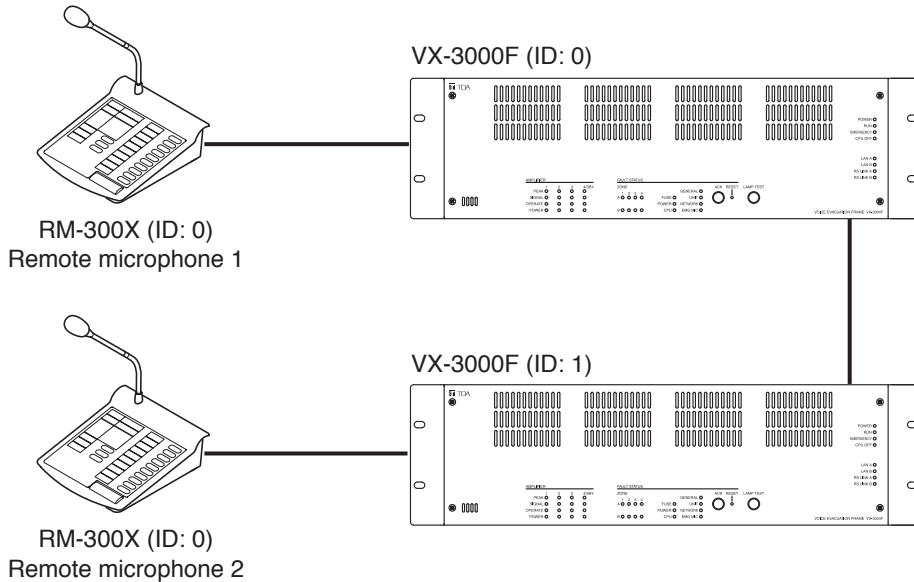

In this example, Remote Microphone 1's broadcast status is set on Remote Microphone 2's Function key 1.

Control input		RM	Fault LED setting	Audio network output setting
Name		VX1-RM0		
RM event settings		VX-3008F(ID:1) ID:0 Model:RM-300X Type:General		
Name	Function	Related control output	Contents1	Contents2
EMG	EMG			
SYS1	SYS1	Activate general/BGM broadcast		EV message
SYS2	SYS2	pre select (individual)	None	ZONE 0-1
SYS3	SYS3	Clear pre selected zones		
TALK	TALK	TALK	None	None
1	KEY1	RM broadcast status		VX0-RM0
2	KEY2	Activate general/BGM broadcast		EV message

Start Remote Microphone 1 broadcast.

The broadcast status indicator set for Remote Microphone 2's Function key 1 continues to light yellow while Remote Microphone 1 is broadcasting.

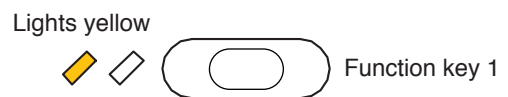

The broadcast status indicator on Remote Microphone 2 goes off after Remote Microphone 1 broadcast is completed.



### 15.2.11. Activate general/BGM broadcast

Audio signals from general EV messages and VX-3000F's/VX-3000PM's audio inputs or remote microphone's AUX inputs can be broadcast over the desired zone(s) by pressing the remote microphone's or VX-3000CT's function key.

Explained here is an example of EV playback.

General EV broadcast operations change as follows depending on the "Playback count" (p. 3-84) selected by clicking "EV message setting."

#### [EV message setting examples]

	Playback count
EV Message 1	1
EV Message 2	Endless

- EV Message 1: When the "Playback count" is set to "1"

The EV message ends after being broadcast once.

Pressing the remote microphone's or VX-3000CT's function key during EV message playback causes the general EV broadcast to end.

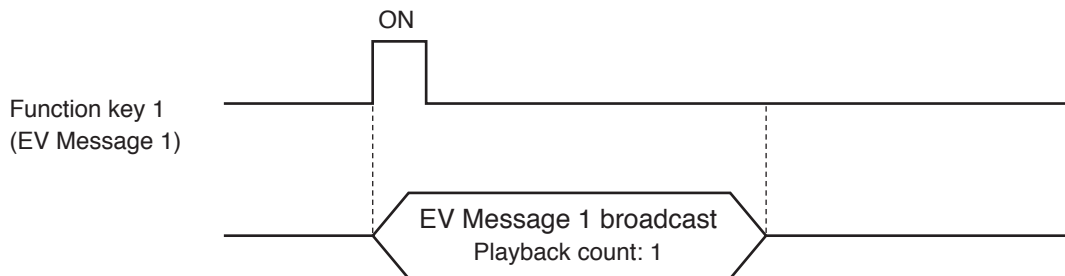

- EV Message 2: When the "Playback count" is set to "Endless"

The general EV broadcast continues to play repeatedly until the remote microphone's or VX-3000CT's function key is pressed.

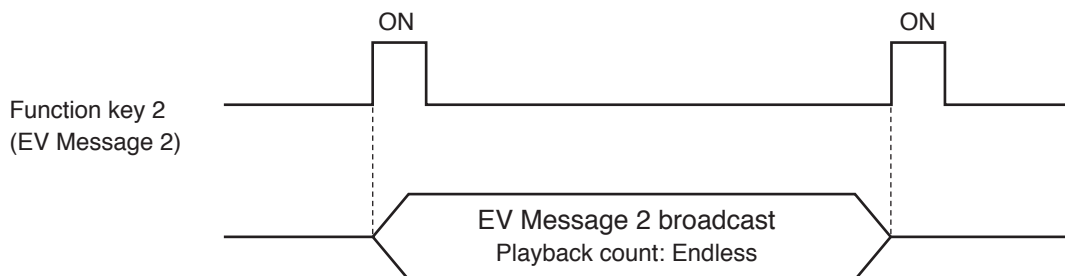

### 15.2.12. Power on (Level), Power on (Pulse), Power on

Controls the switching of the VX-3000F's amplifier power state between active (ON) and sleep modes when the sleep mode has been set to "Used."

The figures below show the timing of the switching.

#### [When switching by the control input (Level)]

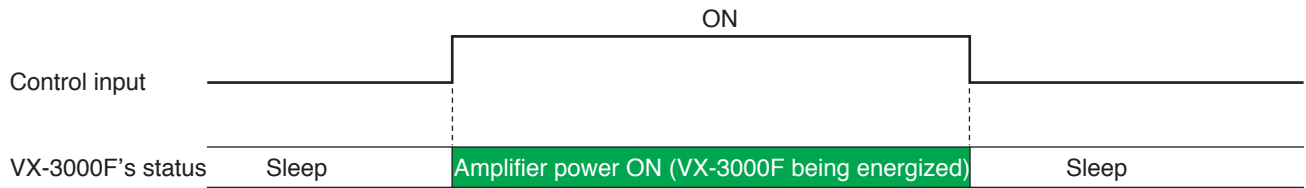

#### [When switching by the control input (Pulse) or the function key]

- Example 1: Operation example when the sleep mode is automatically restored after the sleep shift time set in the Event setting expires

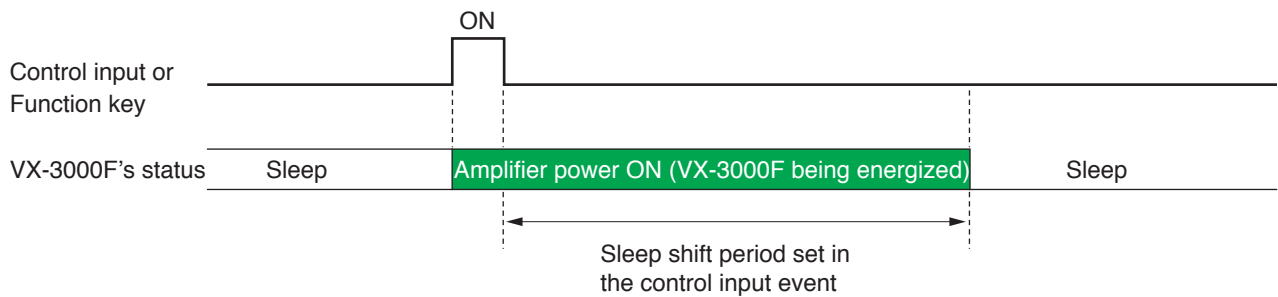

- Example 2: Operation example when the sleep mode is restored by the control input or the function key

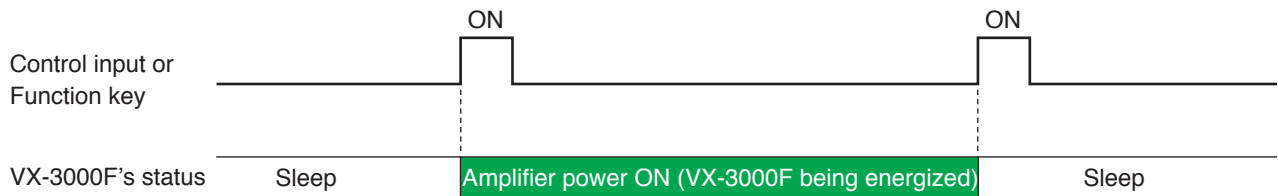

#### Note

During power failure or broadcast, control by the control input and the function key cannot be made.

## 15.3. Control Input Event Setting

Assign functions to the VX-3000F's and VX-3000PM's control inputs.

Clicking the Control input tab on the Event settings screen displays the control input event setting screen.

The screenshot shows the 'Control input' tab selected in the 'Event settings' section. The table below represents the data shown in the interface:

Name (3)	Function (4)	Polarity (5)	Related control output (6)	Contents1 (7)	Contents2 (8)	Contents3 (9)
1 CIN 0-1	Activate general broadcast pattern (Level)	NO	None	General pattern 1		
2 CIN 0-2	Activate general broadcast pattern (Pulse)		None	General pattern 1		
3 CIN 0-3	Activate base broadcast pattern		None	Base pattern 1		
4 CIN 0-4	Interrupt base broadcast pattern					
5 CIN 0-5	Emergency broadcast pattern start	NO		Emergency pattern 1	None	
6 CIN 0-6	Emergency broadcast pattern start/stop	NO		Emergency pattern 1	Pattern stop	
7 CIN 0-7	Emergency broadcast pattern stop	NO		Emergency pattern 1		
8 CIN 0-8	Emergency sequence stop	NO		Emergency sequence 1		
9 CIN 0-9	Emergency sequencephase shift	NO		Emergency sequence 1		
10 CIN 0-10	Emergency reset	NO		No restoration message		
11 CIN 0-11	Emergency warning broadcast	NO	None	Analog 0-1	Pattern	Zone pattern 1
12 CIN 0-12	Fault acknowledge					
13 CIN 0-13	Fault reset					
14 CIN 0-14	External failure input			Failure when turning it on		
15 CIN 0-15	Zone volume attenuation(Level)	NO		-10 [dB]	Pattern	Zone pattern 1
16 CIN 0-16	Zone volume attenuation(Level)	NO		-1 [dB]	Pattern	Zone pattern 1
17 EMG CIN0-17	Input volume adjustment(Pulse)			-10 [dB]	Analog 0-2	
18 EMG CIN0-18	Input volume attenuation(Level)			-1 [dB]	Analog 0-2	

### Tip

To change the column width, move the cursor to each column border and drag the border line left or right.

### (1) Unit number

Click on the box, or click the arrow button to select the desired VX-3000F.

### (2) Copy and Paste buttons

Clicking the Copy button copies all of the on-screen settings except "Name" (3) preset by default.

Select another VX-3000F. Then, clicking the Paste button pastes the copied parameters in the setting screen of the selected by "Unit number" (1).

### (3) Name

Enter each name of the VX-3000F's or VX-3000PM's control inputs.

Available Settings	Up to 32 alphanumeric characters (Default: In the case of the VX-3000F, for example, CIN 0-1 represents the control input No. 1 of the VX-3000F of ID No. 0. In the case of the VX-3000PM, for example, VX0-PM-CIN 1 represents the Control input 1 of the VX-3000PM connected to the VX-3000F (ID No. 0).)
--------------------	---

**(4) Function**

Select functions for the control inputs.

If the selected function needs particular settings, they are displayed on the "Contents."

Available Settings	<p>Not used (default), Activate general broadcast pattern (Level), Activate general broadcast pattern (Pulse), Activate base broadcast pattern, Interrupt base broadcast pattern, Emergency warning broadcast, Zone volume adjustment (Pulse), Zone volume attenuation (Level), Input volume adjustment (Pulse), Input volume attenuation (Level), Time adjustment</p> <p><b>Notes</b></p> <ul style="list-style-type: none"> <li>• Following functions can be selected when the Emergency broadcast function is set to "Used" in the "Basic settings." <ul style="list-style-type: none"> <li>Emergency broadcast pattern start, Emergency broadcast pattern stop, Emergency broadcast pattern start/stop, Emergency sequence stop, Emergency sequence phase shift, Emergency reset, Emergency broadcast silence</li> </ul> </li> <li>• Following functions can be selected when the Fault detect function is set to "Used" in the "Basic settings." <ul style="list-style-type: none"> <li>Fault acknowledge, Fault reset, External failure input</li> </ul> </li> <li>• Following functions can be selected when the sleep mode is set to "Used" in the "Basic settings." <ul style="list-style-type: none"> <li>Power on (Level), Power on (Pulse)</li> </ul> </li> </ul>
--------------------	---

**(5) Polarity**

Set the signal status that is valid when "Function" is set to "Activate general broadcast pattern (Level)," "Emergency warning broadcast," "Zone volume attenuation (Level)," "Emergency broadcast pattern start," "Emergency broadcast pattern stop," "Emergency broadcast pattern start/stop," "Emergency sequence stop," "Emergency sequence phase shift," "Emergency reset," "Emergency broadcast silence," or "Power on (Level)."

When "Function" is set to "External failure input," Polarity is fixed to "NO" and not settable.

**Note**

A make pulse of over 0.1 s becomes a valid signal when any other functions are set.

Available Settings	NO (default), NC
--------------------	------------------

**Tip**

To make "Closed" state a valid signal, select "NO."

To make "Open" state a valid signal, select "NC."

**(6) Related control output**

**[When "Function" is set to "Activate general broadcast pattern (Pulse)," "Activate general broadcast pattern (Level)," "Activate base broadcast pattern," or "Emergency warning broadcast"]**

Select the control output pattern that operates in synchronization with the control input.

Set the control output pattern by selecting "Pattern settings → Control output pattern setting" (p. 3-100).

Available Settings	None (default), Set control output pattern
--------------------	--

**[If "Activate general broadcast pattern (Level)" or "Activate general broadcast pattern (Pulse)" is selected for "Function"]**

**(7) Contents 1**

Select the general broadcast pattern to be activated by the control input.

Set the broadcast pattern by selecting "Pattern settings → General broadcast pattern setting" (p. 3-98).

Available Settings	Set general broadcast pattern
--------------------	-------------------------------

**[If "Activate base broadcast pattern" is selected for "Function"]**

**(7) Contents 1**

Select the base broadcast pattern to be activated by the control input.

Set the base broadcast pattern by selecting "Pattern settings → Base pattern setting" (p. 3-96).

Available Settings	Set base broadcast pattern
--------------------	----------------------------

**[If "Emergency warning broadcast" is selected for "Function"]****(7) Contents 1**

Select the audio source from the pull-down list.

This can be selected when the broadcast "Type" is set to "Emergency warning."

Available Settings	Set audio source name
--------------------	-----------------------

**(8) Contents 2**

Select either the VX-3000F's individual zone or the output zone pattern to determine the zone of which the Emergency warning broadcast is activated by the control input.

Available Settings	Individual zone, Pattern (default)
--------------------	------------------------------------

**(9) Contents 3****[When "Contents 2" is set to "Individual zone"]**

Select the VX-3000F's output zone (individual).

Available Settings	Set output zone (individual)
--------------------	------------------------------

**Note**

When the network area division function is used, the selectable output zones are only those within the same network area of the VX-3000F that makes Emergency warning broadcast.

**[When "Contents 2" is set to "Pattern"]**

Select the output zone pattern.

Set the output zone pattern by selecting "Pattern settings → Output zone pattern setting" (p. 3-93).

Available Settings	Set output zone pattern
--------------------	-------------------------

**Note**

When the network area division function is used, you can select only the output zone pattern that includes the output zones in the same network area of the VX-3000F that makes Emergency warning broadcast.

**Tip**

When the network area division function is used, the output zone pattern name is followed by an asterisk "\*" if the selected output zone pattern includes at least one zone belonging to a different network area so that broadcast cannot be output to such zone.

**[If "Zone volume adjustment (Pulse)" is selected for "Function"]****(7) Contents 1**

Adjust the amount to increase or decrease the sound volume level of the output zone pattern.

Available Settings	-10 to +10 dB (except 0 dB) (default: +1 dB), in 1-dB steps
--------------------	---

**(8) Contents 2**

Select either the VX-3000F's individual zone or the output zone pattern to determine the zone of which volume level is controlled by the control input.

Available Settings	Individual zone, Pattern (default)
--------------------	------------------------------------

**(9) Contents 3****[When "Contents 2" is set to "Individual zone"]**

Select the VX-3000F's output zone (individual).

Available Settings	Set output zone (individual)*
--------------------	-------------------------------

\* The volume level of all zones assigned to the target model is controlled when the VX-3008F's or VX-3016F's zones are included.

If the VX-3016F is set in 2-channel mode, the volume level of zones 1 through 8 is controlled when these zones are included, and that of zones 9 through 16 is controlled when these zones are included.

**[When "Contents 2" is set to "Pattern"]**

Select the output zone pattern.

Set the output zone pattern by selecting "Pattern settings → Output zone pattern setting" (p. 3-93).

Available Settings	Set output zone pattern*
--------------------	--------------------------

\* The volume level of all zones assigned to the target model is controlled when the VX-3008F's or VX-3016F's zones are included.

If the VX-3016F is set in 2-channel mode, the volume level of zones 1 through 8 is controlled when these zones are included, and that of zones 9 through 16 is controlled when these zones are included.

**[If "Zone volume attenuation (Level)" is selected for "Function"]****(7) Contents 1**

Select the attenuation level.

Available Settings	-1 dB, -2 dB, -3 dB, -6 dB, -10 dB (default), -20 dB, -40 dB, -∞ dB
--------------------	---

**(8) Contents 2**

Select either the VX-3000F's individual zone or the output zone pattern to determine the zone of which volume level is decreased by the control input.

Available Settings	Individual zone, Pattern (default)
--------------------	------------------------------------

**(9) Contents 3****[When "Contents 2" is set to "Individual zone"]**

Select the VX-3000F's output zone (individual).

Available Settings	Set output zone (individual)*
--------------------	-------------------------------

\* The volume level of all zones assigned to the target model is controlled when the VX-3008F's or VX-3016F's zones are included.

If the VX-3016F is set in 2-channel mode, the volume level of zones 1 through 8 is controlled when these zones are included, and that of zones 9 through 16 is controlled when these zones are included.

**[When "Contents 2" is set to "Pattern"]**

Select the output zone pattern.

Set the output zone pattern by selecting "Pattern settings → Output zone pattern setting" (p. 3-93).

Available Settings	Set output zone pattern*
--------------------	--------------------------

\* The volume level of all zones assigned to the target model is controlled when the VX-3008F's or VX-3016F's zones are included.

If the VX-3016F is set in 2-channel mode, the volume level of zones 1 through 8 is controlled when these zones are included, and that of zones 9 through 16 is controlled when these zones are included.

**[If "Input volume adjustment (Pulse)" is selected for "Function"]****(7) Contents 1**

Adjust the amount to increase or decrease the sound volume level of the input channel.

Available Settings	-10 to +10 dB (except 0 dB) (default: +1 dB), in 1-dB steps
--------------------	---

**(8) Contents 2**

Select the VX-3000F's input channel.

Available Settings	Name of Audio input (default: Analog 0-1)
--------------------	---

**Note**

This setting is not allowed for the input channel of which audio source type is set to "Emergency warning."

**[If "Input volume attenuation (Level)" is selected for "Function"]****(7) Contents 1**

Select the attenuation level.

Available Settings	-1 dB, -2 dB, -3 dB, -6 dB, -10 dB (default), -20 dB, -40 dB, -∞ dB
--------------------	---

**(8) Contents 2**

Select the VX-3000F's input channel.

Available Settings	Name of Audio input (default: Analog 0-1)
--------------------	---

**Note**

This setting is not allowed for the input channel of which audio source type is set to "Emergency warning."

**[If "Emergency broadcast pattern start" is selected for "Function"]**

Two Emergency broadcast patterns can be activated by a single event.

**Tip**

Emergency broadcast pattern set to Contents 1 is treated as the first activated event inside the unit.

**(7) Contents 1**

Select the emergency broadcast pattern to be activated by the control input.

Set the emergency broadcast pattern by selecting "Pattern settings → Emergency broadcast pattern setting" (p. 3-102).

Available Settings	None (default), Set emergency broadcast pattern
--------------------	---

**(8) Contents 2**

Select the emergency broadcast pattern to be activated by the control input.

Set the emergency broadcast pattern by selecting "Pattern settings → Emergency broadcast pattern setting" (p. 3-102).

Available Settings	None (default), Set emergency broadcast pattern
--------------------	---

**[If "Emergency broadcast pattern stop" is selected for "Function"]****(7) Contents 1**

Select the emergency broadcast pattern to be stopped by the control input.

Set the emergency broadcast pattern by selecting "Pattern settings → Emergency broadcast pattern setting" (p. 3-102).

Available Settings	Set emergency broadcast pattern
--------------------	---------------------------------

**[If "Emergency broadcast pattern start/stop" is selected for "Function"]****(7) Contents 1**

Select the emergency broadcast pattern to be activated or stopped by the control input.

Set the emergency broadcast pattern by selecting "Pattern settings → Emergency broadcast pattern setting" (p. 3-102).

Available Settings	Set emergency broadcast pattern
--------------------	---------------------------------

**(8) Contents 2**

Select the operation when the control input is turned ON during the Emergency broadcast pattern is activated.

Available Settings	Pattern stop (default), Emergency reset
--------------------	---

**(9) Contents 3 (Only when "Contents 2" is set to "Emergency reset")**

Select the EV message (Type: Restoration) to be broadcast by the function key of the remote microphone. Set the EV message by selecting "Internal EV settings → EV message setting" (p. 3-84).

Available Settings	None restoration broadcast (default), Restoration EV message
--------------------	--

**[If "Emergency sequence stop" is selected for "Function"]****(7) Contents 1**

Select the emergency sequence to be stopped by the control input.

Set the emergency sequence by selecting "Pattern settings → Emergency sequence setting" (p. 3-101).

Available Settings	Set emergency sequence
--------------------	------------------------

**[If "Emergency sequence phase shift" is selected for "Function"]****(7) Contents 1**

Select the emergency sequence to be shifted to by the control input.

Set the emergency sequence by selecting "Pattern settings → Emergency sequence setting" (p. 3-101).

Available Settings	Set emergency sequence
--------------------	------------------------

**[If "Emergency reset" is selected for "Function"]****(7) Contents 1**

Select the EV message (Type: Restoration) to be broadcast by the control input.

Set the EV message by selecting "Internal EV setting → EV message setting" (p. 3-84).

Available Settings	No restoration message (default), Restoration EV message
--------------------	--

**[If "External failure input" is selected for "Function"]****(7) Contents 1**

Select the type of contact input to judge to be a failure.

**Note**

Assigning this function to a control input terminal enables this terminal to be selected in the "External failure input" item on the "Failure pattern setting" screen (p. 3-105).

Available Settings	Failure when turning it on (default), Failure when turning it off
--------------------	---

**[If "Power on (Pulse)" is selected for "Function"]****(7) Contents 1**

Set the shift time to make the device automatically placed into the sleep mode when the state that neither operation nor broadcast is made continues.

Available Settings	No automatic sleep transition (default), Sleep transition time 1 to 10 minutes (1 minutes step)
--------------------	---

## 15.4. RM Event Setting

Set the functions to be assigned to the emergency keys and function keys on the RM-200SF and RM-300X, and the function keys on the RM-320F and RM-210F.

Clicking the RM tab on the Event settings screen displays the RM event settings screen.

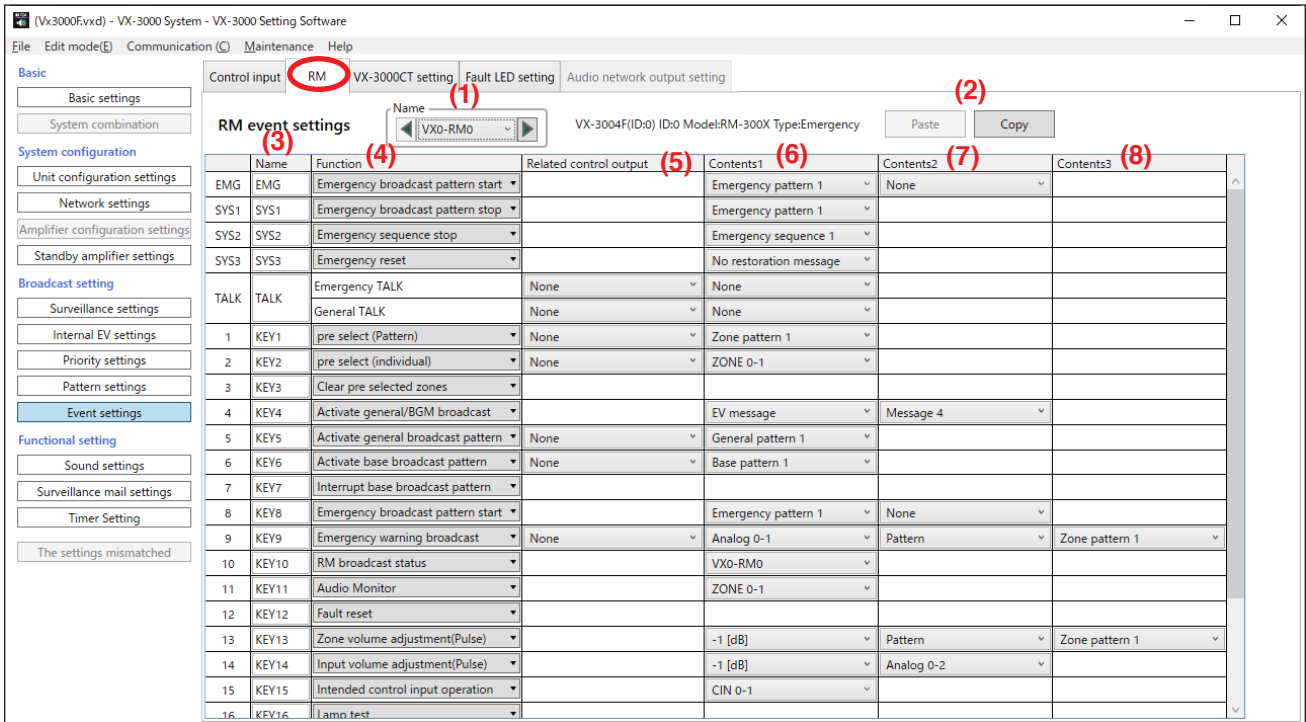

### (1) Name (Remote microphone)

Click on the box or click the arrow button to select the desired RM-200SF or RM-300X.

Function keys of the RM-320F and RM-210F are also displayed on the screen when the remote microphone to which the RM-320F or RM-210F is connected is selected.

See p. 3-61 "Setting the Remote Microphone Configuration."

### (2) Copy and Paste buttons

Clicking the Copy button copies all of the on-screen settings except "Name" (3) preset by default.

Select another RM-200SF or RM-300X. Then, clicking the Paste button pastes the copied parameters in the setting screen of the selected "Name" (1).

### (3) Name (Key)

Enter the names of the keys of the RM-200SF, RM-300X, RM-320F, and RM-210F.

Available Settings	Up to 32 alphanumeric characters (Default: EMG for the Emergency key, SYS 1 – 3 and KEY 1 – up for the Function keys)
--------------------	---

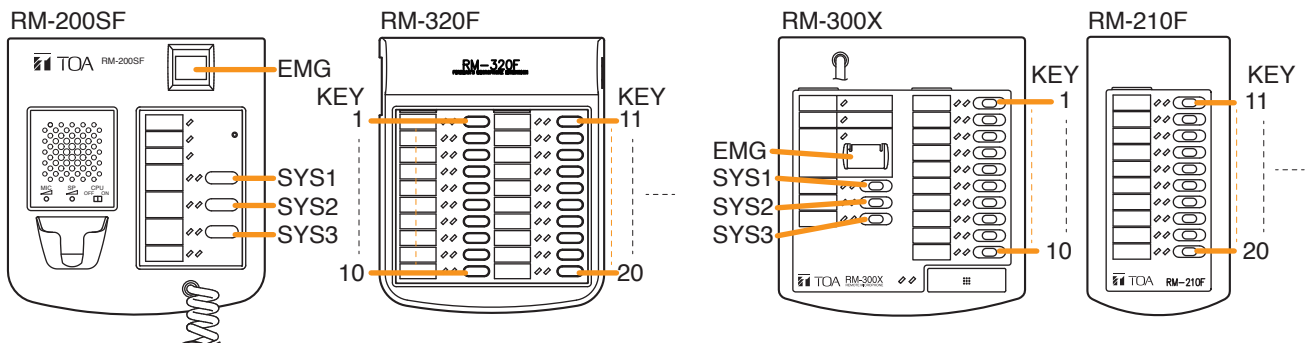

**(4) Function**

Select functions to be assigned to the keys of the RM-200SF, RM-300X, RM-320F, and RM-210F.  
If the selected function needs particular settings, they are displayed on the "Contents."

Available Settings	<p>Not used (default), Activate base broadcast pattern, Interrupt base broadcast pattern, Emergency warning broadcast, Zone volume adjustment (Pulse), Input volume adjustment (Pulse), Activate general broadcast pattern, RM broadcast status, Activate general/BGM broadcast, Pre select (Pattern), Pre select (Individual), Clear pre selected zones, Lamp test, Audio Monitor</p> <p><b>Notes</b></p> <ul style="list-style-type: none"> <li>• Following functions can also be selected when the "Emergency broadcast function" has been set to "Used" in the "Basic settings" and when Remote microphone's "Type" is set to "Emergency" or "Emergency/General." <ul style="list-style-type: none"> <li>Emergency broadcast pattern start, Emergency broadcast pattern stop, Emergency broadcast pattern start/stop, Emergency sequence stop, Emergency sequence phase shift, Emergency reset, Emergency broadcast silence, Emergency EV broadcast, Emergency acknowledge, Disablement of EMG control from CIN</li> </ul> </li> <li>• Following functions can also be selected when the Fault detect function has been set to "Auto reset" or "Manual reset" in the "Basic settings." <ul style="list-style-type: none"> <li>Fault acknowledge, Fault reset</li> </ul> </li> <li>• Following functions can also be selected when the function is assigned to the control input in the "Event settings." <ul style="list-style-type: none"> <li>Intended control input operation</li> </ul> </li> <li>• Following functions can also be selected when the control output pattern is set in the "Pattern settings." <ul style="list-style-type: none"> <li>Intended control output operation (Pulse), Intended control output operation (Level)</li> </ul> </li> <li>• A following function can be selected when the sleep mode is set to "Used" in the "Basic settings." <ul style="list-style-type: none"> <li>Power on</li> </ul> </li> </ul>
--------------------	---

**(5) Related control output**

[When "Function" is set to "Activate general broadcast pattern," "Activate base broadcast pattern," "Pre select (pattern)," "Pre select (individual)," "Emergency warning broadcast," "TALK," "Emergency TALK," or "General TALK"]

Select the control output pattern to be synchronously activated when the remote microphone's function key or Talk key is pressed.

Set the control output pattern by selecting "Pattern settings → Control output pattern setting" (p. 3-100).

Available Settings	None (default), Set control output pattern
--------------------	--

**Note**

When "Function" is set to "TALK," "Emergency TALK," or "General TALK," it is not possible to set only the Interlock control output.

Set the output zone and the output zone pattern, then the Interlock control output.

**Tip**

The timing that the control output pattern is activated when the "Pre select (Pattern)"-assigned or "Pre select (Individual)"-assigned function key is pressed follows the timing set in the "Activation timing for related control output" (p. 3-39) in the "Basic settings."

**[If "Emergency warning broadcast" is selected for "Function"]**

**(6) Contents 1**

Select the audio source from the pull-down list.

This can be selected when the broadcast "Type" is set to "Emergency warning."

Available Settings	Set audio source name
--------------------	-----------------------

**(7) Contents 2**

Select either the VX-3000F's individual zone or the output zone pattern to determine the zone of which the Emergency warning broadcast is activated by the function key or emergency key of the remote microphone.

Available Settings	Individual zone, Pattern (default)
--------------------	------------------------------------

**(8) Contents 3****[When "Contents 2" is set to "Individual zone"]**

Select the VX-3000F's output zone (individual).

Available Settings	Set output zone (individual)
--------------------	------------------------------

**Note**

When the network area division function is used, the selectable output zones are only those within the same network area of the VX-3000F that makes Emergency warning broadcast.

**[When "Contents 2" is set to "Pattern"]**

Select the output zone pattern

Set the output zone pattern by selecting "Pattern settings → Output zone pattern setting" (p. 3-93).

Available Settings	Set output zone pattern
--------------------	-------------------------

**Note**

When the network area division function is used, you can select only the output zone pattern that includes the output zones in the same network area of the VX-3000F that makes Emergency warning broadcast.

**Tip**

When the network area division function is used, the output zone pattern name is followed by an asterisk "\*" if the selected output zone pattern includes at least one zone belonging to a different network area so that broadcast cannot be output to such zone.

**[If "Zone volume adjustment (Pulse)" is selected for "Function"]****(6) Contents 1**

Adjust the amount to increase or decrease the sound volume level of the output zones.

Available Settings	-10 to +10 dB (except 0 dB) (default: +1 dB), in 1-dB steps
--------------------	---

**(7) Contents 2**

Select either the VX-3000F's individual zone or the output zone pattern to determine the zone of which volume level is controlled by the function key of the remote microphone.

Available Settings	Individual zone, Pattern (default)
--------------------	------------------------------------

**(8) Contents 3****[When "Contents 2" is set to "Individual zone"]**

Select the VX-3000F's output zone (individual).

Available Settings	Set output zone (individual)*
--------------------	-------------------------------

\* The volume level of all zones assigned to the target model is controlled when the VX-3008F's or VX-3016F's zones are included.

If the VX-3016F is set in 2-channel mode, the volume level of zones 1 through 8 is controlled when these zones are included, and that of zones 9 through 16 is controlled when these zones are included.

**[When "Contents 2" is set to "Pattern"]**

Select the output zone pattern.

Set the output zone pattern by selecting "Pattern settings → Output zone pattern setting" (p. 3-93).

Available Settings	Set output zone pattern*
--------------------	--------------------------

\* The volume level of all zones assigned to the target model is controlled when the VX-3008F's or VX-3016F's zones are included.

If the VX-3016F is set in 2-channel mode, the volume level of zones 1 through 8 is controlled when these zones are included, and that of zones 9 through 16 is controlled when these zones are included.

**[If "Input volume adjustment (Pulse)" is selected for "Function"]****(7) Contents 1**

Adjust the amount to increase or decrease the sound volume level of the input channel.

Available Settings	-10 to +10 dB (except 0 dB) (default: +1 dB), in 1-dB steps
--------------------	---

**(8) Contents 2**

Select the VX-3000F's input channel.

Available Settings	Name of Audio input (default: Analog 0-1)
--------------------	---

**Note**

This setting is not allowed for the input channel of which audio source type is set to "Emergency warning."

**[If "Activate general broadcast pattern" is selected for "Function"]****(6) Contents 1**

Select the general broadcast pattern to be activated by the function key of the remote microphone.

Set the general broadcast pattern by selecting "Pattern settings → General broadcast pattern setting" (p. 3-98).

Available Settings	Set general broadcast pattern
--------------------	-------------------------------

**Note**

The Start chime, the End chime, and the Chime sound source set in the general pattern do not sound from the general remote microphone in operation.

**[If "Activate base broadcast pattern" is selected for "Function"]****(6) Contents 1**

Select the base broadcast pattern to be activated by the function key of the remote microphone.

Set the base broadcast pattern by selecting "Pattern settings → Base pattern setting" (p. 3-96).

Available Settings	Set base broadcast pattern
--------------------	----------------------------

**[If "Emergency broadcast pattern start" is selected for "Function"]**

Two Emergency broadcast patterns can be activated by a single key operation.

**Tip**

Emergency broadcast pattern set to Contents 1 is treated as the first activated event inside the unit.

**(6) Contents 1**

Select the emergency broadcast pattern to be activated by the function key or emergency key of the remote microphone.

Set the emergency broadcast pattern by selecting "Pattern settings → Emergency broadcast pattern setting" (p. 3-102).

Available Settings	None (default), Set emergency broadcast pattern
--------------------	---

**(7) Contents 2**

Select the emergency broadcast pattern to be activated by the function key or emergency key of the remote microphone.

Set the emergency broadcast pattern by selecting "Pattern settings → Emergency broadcast pattern setting" (p. 3-102).

Available Settings	None (default), Set emergency broadcast pattern
--------------------	---

**[If "Emergency broadcast pattern stop" is selected for "Function"]****(6) Contents 1**

Select the emergency broadcast pattern to be stopped by the function key of the remote microphone.  
Set the emergency broadcast pattern by selecting "Pattern settings → Emergency broadcast pattern setting" (p. 3-102).

Available Settings	Set emergency broadcast pattern
--------------------	---------------------------------

**[If "Emergency broadcast pattern start/stop" is selected for "Function"]****(6) Contents 1**

Select the emergency broadcast pattern to be activated by the function key or emergency key of the remote microphone.

Set the emergency broadcast pattern by selecting "Pattern settings → Emergency broadcast pattern setting" (p. 3-102).

Available Settings	Set emergency broadcast pattern
--------------------	---------------------------------

**(7) Contents 2**

Select the operation when the function key of the remote microphone is pressed during the Emergency broadcast pattern is activated.

Available Settings	Pattern stop (default), Emergency reset
--------------------	---

**(8) Contents 3 (Only when "Contents 2" is set to "Emergency reset")**

Select the EV message (Type: Restoration) to be broadcast by the function key of the remote microphone.  
Set the EV message by selecting "Internal EV settings → EV message setting" (p. 3-84).

Available Settings	None restoration broadcast (default), Restoration EV message
--------------------	--

**[If "Emergency sequence stop" is selected for "Function"]****(6) Contents 1**

Select the emergency sequence to be stopped by the function key of the remote microphone.  
Set the emergency sequence by selecting "Pattern settings → Emergency sequence setting" (p. 3-101).

Available Settings	Set emergency sequence
--------------------	------------------------

**[If "Emergency sequence phase shift" is selected for "Function"]****(6) Contents 1**

Select the emergency sequence to be shifted to by the function key of the remote microphone.  
Set the emergency sequence by selecting "Pattern settings → Emergency sequence setting" (p. 3-101).

Available Settings	Set emergency sequence
--------------------	------------------------

**[If "Emergency reset" is selected for "Function"]****(6) Contents 1**

Select the EV message (Type: Restoration) to be broadcast by the function key of the remote microphone.  
Set the EV message by selecting "Internal EV settings → EV message setting" (p. 3-84).

Available Settings	None restoration broadcast (default), Restoration EV message
--------------------	--

**[If "Emergency EV broadcast" is selected for "Function"]****(6) Contents 1**

Select the type of EV message to be broadcast by the function key of the remote microphone.  
Set the EV message by selecting "Internal EV settings → EV message setting" (p. 3-84).

Available Settings	Evacuate (default), Alert
--------------------	---------------------------

**(7) Contents 2**

Select the EV message No. to be broadcast by the function key of the remote microphone.  
Set the EV message by selecting "Internal EV settings → EV message setting" (p. 3-84).

Available Settings	Registered EV message No.
--------------------	---------------------------

**[If "Emergency acknowledge" is selected for "Function"]****(6) Contents 1**

Select whether the target of emergency acknowledge is the whole system or individual remote microphones.

Available Settings	System all at once (default), RM individual
--------------------	---

**(7) Contents 2**

Set whether or not to give notice of the emergency acknowledge again with the buzzer and indicator if other emergency broadcast pattern is activated after the emergency acknowledge operation has been performed.

Available Settings	Re-notification ON (default), Re-notification OFF
--------------------	---

**(8) Contents 3**

Set whether to enable the emergency operation\* from the remote microphone only after the emergency acknowledge operation is performed or to enable the emergency operation\* from the remote microphone without performing emergency acknowledge operation.

Available Settings	EMG enable operation ON (default), EMG enable operation OFF
--------------------	---

\* All operations related to the emergency broadcasts such as Emergency broadcast pattern start/stop, Emergency sequence phase shift, and Emergency reset.

**[If "Disabling of EMG control from CIN" is selected for "Function"]****(6) Contents 1**

Set whether or not to notify that the emergency activation from the control input is disabled.

Available Settings	Notification buzzer for careless: OFF (default), Notification buzzer for careless: ON
--------------------	---

"Notification buzzer for careless: OFF":

Notice is not made.

"Notification buzzer for careless: ON":

While the emergency activation from the control input remains disabled, a beep tone will sound once every 10 seconds at the remote microphone, preventing the user from failing to turn off the "Disabling the emergency activation from the control input" setting.

**[If "Fault acknowledge" is selected for "Function"]****(6) Contents 1**

Select the failure pattern to be assigned to the function key of the remote microphone.  
Set the failure pattern by selecting "Pattern settings → Failure pattern setting" (p. 3-105).

Available Settings	Set failure pattern
--------------------	---------------------

**[If "RM broadcast status" is selected for "Function"]****(6) Contents 1**

Select the Name of the remote microphone to monitor.

Available Settings	Set Name of remote microphone
--------------------	-------------------------------

**[If "Activate general/BGM broadcast" is selected for "Function"]****(6) Contents 1**

Select the sound source used for General broadcast.

Available Settings	EV message, Audio Input, AUX
--------------------	------------------------------

**(7) Contents 2****[When "Contents 1" is set to "EV message"]**

Select the general or BGM EV message to be activated with remote microphone key operation.

Use the "Internal EV setting" (p. 3-81 "Registering sound sources") to register the general or BGM EV message.

Settings cannot be performed unless the general or BGM EV message has been registered.

Available Settings	Set general or BGM EV message (default: the lowest EV message No. of all set general EV messages)
--------------------	---

**[When "Contents 1" is set to "Audio Input"]**

Select the Audio input to use.

Available Settings	Name of Audio input (default: Analog 0-1)
--------------------	---

**Note**

When the network area division function is used, you can select only the audio input available for broadcast to the network area set to the VX-3000F to which the remote microphone is connected.

**[When "Contents 1" is set to "AUX"]**

Select the remote microphone having the AUX input to use.

Available Settings	Name of remote microphone
--------------------	---------------------------

**Note**

When the network area division function is used, you can select only the AUX input available for broadcast to the network area set to the VX-3000F to which the remote microphone is connected.

**[If "Pre select (Pattern)" is selected for "Function"]****(6) Contents 1**

Select the output zone pattern to be assigned to the function key of the remote microphone.

Set the output pattern by selecting "Pattern settings → Output zone pattern setting" (p. 3-93).

Available Settings	Set output zone pattern
--------------------	-------------------------

**Note**

When the network area division function is used, you can select only the output zone pattern within the network area set to the VX-3000F to which the remote microphone is connected.

**[If "Pre select (Individual)" is selected for "Function"]****(6) Contents 1**

Select the output zone (individual) to be assigned to the function key of the remote microphone.

Available Settings	Set output zone (individual)
--------------------	------------------------------

**Note**

When the network area division function is used, you can select only the output zone within the network area set to the VX-3000F to which the remote microphone is connected.

**[If "Audio monitor" is selected for "Function"]****(6) Contents 1**

Select the output zone (individual) to monitor.

Available Settings	Set output zone (individual)
--------------------	------------------------------

**[If "Intended control input operation" is selected for "Function"]****(6) Contents 1**

Select the Control input to control.

Available Settings	Set control input
--------------------	-------------------

**[If "Intended control output operation (Level)" or "Intended control output operation (Pulse)" is selected for "Function"]****(6) Contents 1**

Select the Control output pattern to control.

Set the control output pattern by selecting "Pattern settings → Control output pattern setting" (p. 3-100).

Available Settings	Set control output pattern
--------------------	----------------------------

**[If "Power on" is selected for "Function"]****(6) Contents 1**

Set the shift time to make the device automatically placed into the sleep mode when the state that neither operation nor broadcast is made continues.

Available Settings	No automatic sleep transition (default), Sleep transition time 1 to 10 minutes (1 minutes step)
--------------------	---

**[If "Talk," "Emergency TALK," or "General TALK" is selected for "Function"]****(6) Contents 1**

When the remote microphone's "Type" is set to "General," the function is fixed to "TALK."

When the remote microphone's "Type" is set to "Emergency" or "Emergency/General," 2 functions can be set: "Emergency TALK" and "General TALK."

Assign the talk key operation performed when in emergency broadcast state to the "Emergency TALK" and that performed when in normal state to the "General TALK." Functions can be separately used depending on the broadcast state.

Settable contents are the same for "TALK," "Emergency TALK," and "General TALK."

**(7) Contents 2****[When "Contents 1" is set to "Individual zone"]**

Select the VX-3000F's output zone (individual).

Available Settings	Set output zone (individual)
--------------------	------------------------------

**Note**

When the network area division function is used, you can select only the output zone within the network area set to the VX-3000F to which the remote microphone is connected.

**[When "Contents 1" is set to "Pattern"]**

Select the output zone pattern.

Set the output zone pattern by selecting "Pattern settings → Output zone pattern setting" (p. 3-93).

Available Settings	Set output zone pattern
--------------------	-------------------------

**Note**

When the network area division function is used, you can select only the output zone pattern within the network area set to the VX-3000F to which the remote microphone is connected.

**Tip**

When the network area division function is used, the output zone pattern name is followed by an asterisk "\*" if the selected output zone pattern includes at least one zone belonging to a different network area so that broadcast cannot be output to such zone.

## 15.5. VX-3000CT Setting

Set the functions to be assigned to the volume control knobs and function keys on the VX-3000CT. Clicking the VX-3000CT setting tab on the Event settings screen displays the VX-3000CT settings screen.

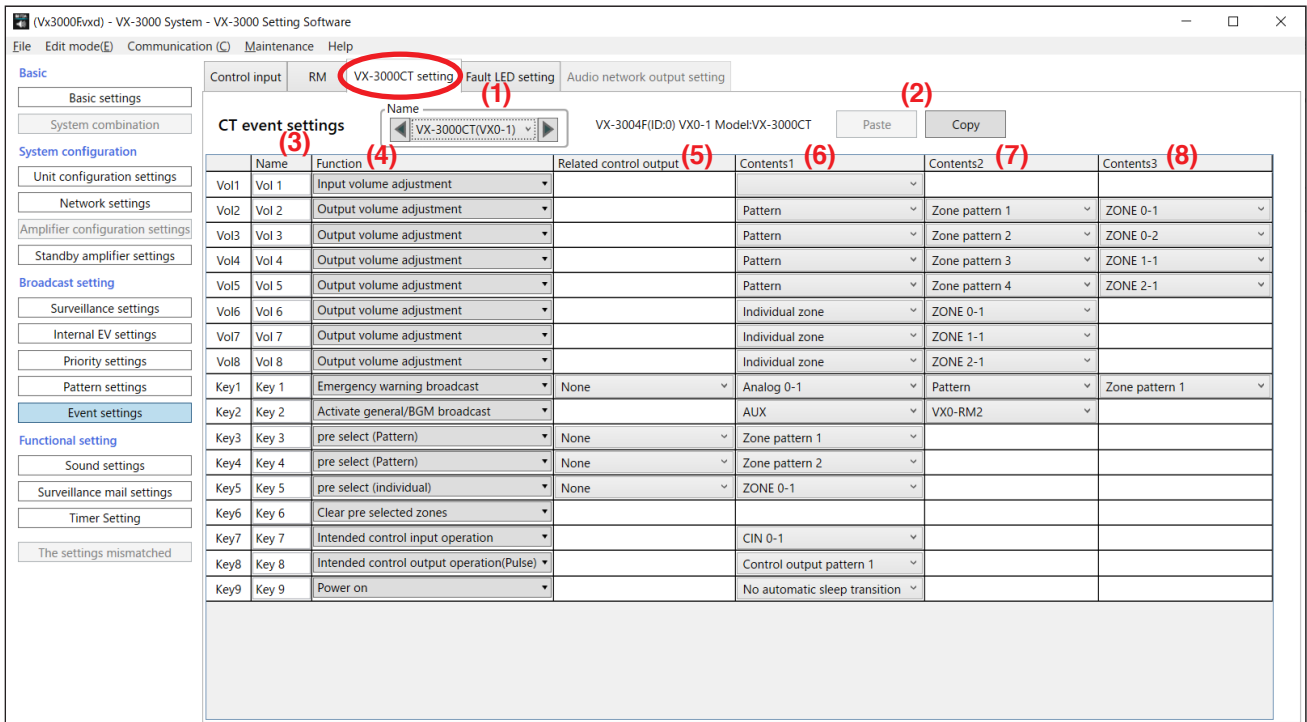

### (1) Name (VX-3000CT)

Click on the box or click the arrow button to select the desired VX-3000CT.

### (2) Copy and Paste buttons

Clicking the Copy button copies all of the on-screen settings except "Name" (3) preset by default. Select another VX-3000CT. Then, clicking the Paste button pastes the copied parameters in the setting screen of the selected by "Name" (1).

### (3) Name (volume control kobs and function keys)

Enter each name of the VX-3000CT's volume control knobs and function keys.

Available Settings	Up to 32 alphanumeric characters (Default: vol1 to 8 for volume control knobs, KEY1 to 9 for function keys)
--------------------	---

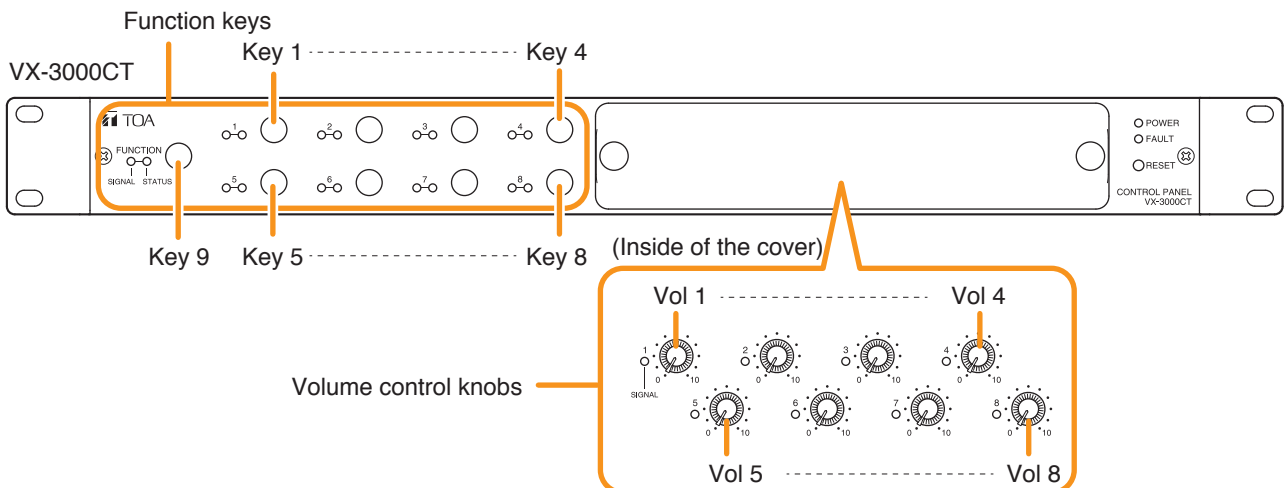

**(4) Function**

Select functions for the volume control knobs and function keys.

If the selected function needs particular settings, they are displayed on the "Contents."

[For volume control knobs]

Available Settings	Not used (default), Input volume adjustment, Output volume adjustment
--------------------	---

[For function keys]

Available Settings	<p>Not used (default), Activate base broadcast pattern, Interrupt base broadcast pattern, Emergency warning broadcast, Zone volume adjustment (Pulse), Input volume adjustment (Pulse), Activate general broadcast pattern, Activate general/BGM broadcast, Pre select (Pattern), Pre select (Individual), Clear pre selected zones</p> <p><b>Notes</b></p> <ul style="list-style-type: none"> <li>• A following function can also be selected when the function is assigned to the control input in the "Event settings." Intended control input operation</li> <li>• Following functions can also be selected when the control output pattern is set in the "Pattern settings." Intended control output operation (Pulse), Intended control output operation (Level)</li> <li>• A following function can be selected when the sleep mode is set to "Used" in the "Basic settings." Power on</li> </ul>
--------------------	--

**(5) Related control output**

**[When "Function" is set to "Activate general broadcast pattern," "Activate base broadcast pattern," "Emergency warning broadcast," "Pre select (pattern)," or "Pre select (individual)]**

Select the control output pattern to be synchronously activated when the VX-3000CT's function key is pressed.

Set the control output pattern by selecting "Pattern settings → Control output pattern setting" (p. 3-100).

Available Settings	None (default), Set control output pattern
--------------------	--

**Tip**

The timing that the control output pattern is activated when the "Pre select (Pattern)"-assigned or "Pre select (Individual)"-assigned function key is pressed follows the timing set in the "Activation timing for related control output" (p. 3-39) in the "Basic settings."

**[If "Input volume adjustment" is selected for "Function"]**

**(6) Contents 1**

Select the VX-3000F's input channel to be assigned to the VX-3000CT's volume control knob.

Available Settings	Name of Audio input (default: Analog 0-1)
--------------------	---

**Notes**

- This setting is not allowed for the input channel of which audio source type is set to "Emergency warning."
- The VX-3000PM's input channels cannot be selected.

**[If "Output volume adjustment" is selected for "Function"]**

**(6) Contents 1**

Select the VX-3000F's individual zone or output zone pattern to set the zones to be assigned to the VX-3000CT's volume control knob.

Available Settings	Individual zone, Pattern (default)
--------------------	------------------------------------

**(7) Contents 2**

**[When "Contents 1" is set to "Individual zone"]**

Select the VX-3000F's output zone (individual).

Available Settings	Set output zone (individual)
--------------------	------------------------------

**[When "Contents 1" is set to "Pattern"]**

Select the output zone pattern.

Set the output zone pattern by selecting "Pattern settings → Output zone pattern setting" (p. 3-93).

Available Settings	Set output zone pattern
--------------------	-------------------------

**(8) Contents 3 (Only when "Contents 1" is set to "Pattern")**

Select the VX-3000F's output zones (Individual) that make their audio signal state (presence or absence) shown on the VX-3000CT's signal indicator.

Available Settings	Set output zone (individual) set in "Contents 2" output zone pattern
--------------------	--

**[If "Emergency warning broadcast" is selected for "Function"]****(6) Contents 1**

Select the audio source from the pull-down list.

This can be selected when the broadcast "Type" is set to "Emergency warning."

Available Settings	Set audio source name
--------------------	-----------------------

**(7) Contents 2**

Select either the VX-3000F's individual zone or the output zone pattern to determine the zone of which the Emergency warning broadcast is activated by the function key of the VX-3000CT.

Available Settings	Individual zone, Pattern (default)
--------------------	------------------------------------

**(8) Contents 3****[When "Contents 2" is set to "Individual zone"]**

Select the VX-3000F's output zone (individual).

Available Settings	Set output zone (individual)
--------------------	------------------------------

**Note**

When the network area division function is used, the selectable output zones are only those within the same network area of the VX-3000F that makes Emergency warning broadcast.

**[When "Contents 2" is set to "Pattern"]**

Select the output zone pattern.

Set the output zone pattern by selecting "Pattern settings → Output zone pattern setting" (p. 3-93).

Available Settings	Set output zone pattern
--------------------	-------------------------

**Note**

When the network area division function is used, you can select only the output zone pattern that includes the output zones in the same network area of the VX-3000F that makes Emergency warning broadcast.

**Tip**

When the network area division function is used, the output zone pattern name is followed by an asterisk "\*" if the selected output zone pattern includes at least one zone belonging to a different network area so that broadcast cannot be output to such zone.

**[If "Zone volume adjustment (Pulse)" is selected for "Function"]****(6) Contents 1**

Adjust the amount to increase or decrease the sound volume level of the output zones.

Available Settings	-10 to +10 dB (except 0 dB) (default: +1 dB), in 1-dB steps
--------------------	---

**(7) Contents 2**

Select either the VX-3000F's individual zone or the output zone pattern to determine the zone of which volume level is controlled by the function key of the VX-3000CT.

Available Settings	Individual zone, Pattern (default)
--------------------	------------------------------------

**(8) Contents 3****[When "Contents 2" is set to "Individual zone"]**

Select the VX-3000F's output zone (individual).

Available Settings	Set output zone (individual)*
--------------------	-------------------------------

\* The volume level of all zones assigned to the target model is controlled when the VX-3008F's or VX-3016F's zones are included.

If the VX-3016F is set in 2-channel mode, the volume level of zones 1 through 8 is controlled when these zones are included, and that of zones 9 through 16 is controlled when these zones are included.

**[When "Contents 2" is set to "Pattern"]**

Select the output zone pattern.

Set the output zone pattern by selecting "Pattern settings → Output zone pattern setting" (p. 3-93).

Available Settings	Set output zone pattern*
--------------------	--------------------------

\* The volume level of all zones assigned to the target model is controlled when the VX-3008F's or VX-3016F's zones are included.

If the VX-3016F is set in 2-channel mode, the volume level of zones 1 through 8 is controlled when these zones are included, and that of zones 9 through 16 is controlled when these zones are included.

**[If "Input volume adjustment (Pulse)" is selected for "Function"]****(7) Contents 1**

Adjust the amount to increase or decrease the sound volume level of the input channel.

Available Settings	-10 to +10 dB (except 0 dB) (default: +1 dB), in 1-dB steps
--------------------	---

**(8) Contents 2**

Select the VX-3000F's input channel.

Available Settings	Name of Audio input (default: Analog 0-1)
--------------------	---

**Note**

This setting is not allowed for the input channel of which audio source type is set to "Emergency warning."

**[If "Activate general broadcast pattern" is selected for "Function"]****(6) Contents 1**

Select the general broadcast pattern to be activated by the function key of the VX-3000CT.

Set the general broadcast pattern by selecting "Pattern settings → General broadcast pattern setting" (p. 3-98).

Available Settings	Set general broadcast pattern
--------------------	-------------------------------

**[If "Activate base broadcast pattern" is selected for "Function"]****(6) Contents 1**

Select the base broadcast pattern to be activated by the function key of the VX-3000CT.

Set the base broadcast pattern by selecting "Pattern settings → Base pattern setting" (p. 3-96).

Available Settings	Set base broadcast pattern
--------------------	----------------------------

**[If "Activate general/BGM broadcast" is selected for "Function"]****(6) Contents 1**

Select the sound source used for General broadcast.

Available Settings	EV message, Audio Input, AUX
--------------------	------------------------------

**(7) Contents 2****[When "Contents 1" is set to "EV message"]**

Select the general or BGM EV message to be activated with the VX-3000CT's key operation.

Use the "Internal EV setting" (p. 3-81) to register the general or BGM EV message.

Settings cannot be performed unless the general or BGM EV message has been registered.

Available Settings	Set general or BGM EV message (default: the lowest EV message No. of all set general EV messages)
--------------------	---

**[When "Contents 1" is set to "Audio Input"]**

Select the Audio input to use.

Available Settings	Name of Audio input (default: Analog 0-1)
--------------------	---

**Note**

When the network area division function is used, you can select only the audio input available for broadcast to the network area set to the VX-3000F to which the VX-3000CT is connected.

**[When "Contents 1" is set to "AUX"]**

Select the remote microphone having the AUX input to use.

Available Settings	Name of remote microphone
--------------------	---------------------------

**Note**

When the network area division function is used, you can select only the AUX input available for broadcast to the network area set to the VX-3000F to which the VX-3000CT is connected.

**[If "Pre select (Pattern)" is selected for "Function"]****(6) Contents 1**

Select the output zone pattern to be assigned to the function key of the VX-3000CT.

Set the output pattern by selecting "Pattern settings → Output zone pattern setting" (p. 3-93).

Available Settings	Set output zone pattern
--------------------	-------------------------

**Note**

When the network area division function is used, you can select only the output zone within the network area set to the VX-3000F to which the VX-3000CT is connected.

**[If "Pre select (Individual)" is selected for "Function"]****(6) Contents 1**

Select the output zone (individual) to be assigned to the function key of the VX-3000CT.

Available Settings	Set output zone (individual)
--------------------	------------------------------

**Note**

When the network area division function is used, you can select only the output zone pattern within the network area set to the VX-3000F to which the VX-3000CT is connected.

**[If "Intended control input operation" is selected for "Function"]****(6) Contents 1**

Select the Control input to control.

Available Settings	Set control input
--------------------	-------------------

**[If "Intended control output operation (Level)" or "Intended control output operation (Pulse)" is selected for "Function"]****(6) Contents 1**

Select the Control output pattern to control.

Set the control output pattern by selecting "Pattern settings → Control output pattern setting" (p. 3-100).

Available Settings	Set control output pattern
--------------------	----------------------------

[If "Power on" is selected for "Function"]

## (6) Contents 1

Set the shift time to make the device automatically placed into the sleep mode when the state that neither operation nor broadcast is made continues.

Available Settings	No automatic sleep transition (default), Sleep transition time 1 to 10 minutes (1 minutes step)
--------------------	---

## 15.6. Fault LED Setting

Set Fault contents to be shown by the VX-3000F's Fault status indicator.

Clicking the Fault LED setting tab on the Event Settings screen displays the Fault LED settings screen.

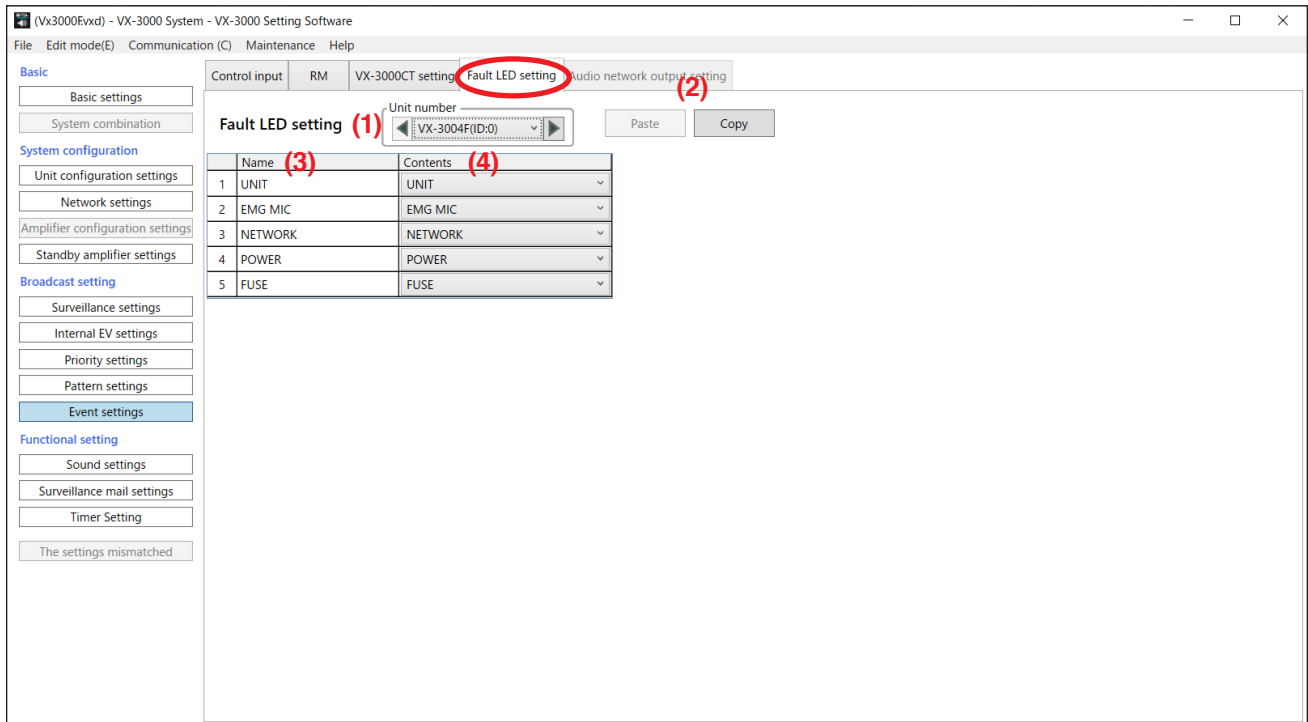

### (1) Unit number

Click on the box, or click the arrow button to select the desired VX-3000F.

### (2) Copy and Paste buttons

Clicking the Copy button copies all of the on-screen settings except "Name" (3) preset by default.

Select another VX-3000F. Then, clicking the Paste button pastes the copied parameters in the setting screen of the selected "Unit number" (1).

### (3) Name

Displays the VX-3000F's front-mounted fault indicator name.

### (4) Contents

Select fault content to be shown by each VX-3000F's front-mounted fault indicator.

Each indicator's default setting is as follows.

When the failure patterns are set in advance, it is also possible to display 2 or more failures on a single indicator by selecting the pattern.

#### • UNIT

Available Settings	UNIT (default), Set Failure pattern
--------------------	-------------------------------------

- **EMG MIC**

Available Settings	EMG MIC (default), Set Failure pattern
--------------------	--

**Note**

While in a CPU OFF state, the emergency microphone fault indicator goes out regardless of this setting.

- **NETWORK**

Available Settings	NETWORK (default), Set Failure pattern
--------------------	--

- **POWER**

Available Settings	POWER (default), Set Failure pattern
--------------------	--------------------------------------

- **FUSE**

Available Settings	FUSE (default), Set Failure pattern
--------------------	-------------------------------------

## 15.7. Audio Network Output Setting

Audio signals being output to the VX-3000F can be output to the NX-300's output zones. Set which audio signals being output to the VX-3000F's zones to be output to the NX-300. Also, set the broadcast priority level within the NX-300 system.

Clicking the Audio network output setting tab on the Event Settings screen displays the Audio network output setting screen.

The NX-300 units set in the audio network output device setting on the network setting screen are listed. Each NX-300 unit has 2 output zones.

IP Address	Equipment	ZONE	NX zone priority	VX zone
192.168.14.100	NX-300	ZONE1	1	ZONE 0-1
192.168.14.100	NX-300	ZONE2	1	ZONE 1-1
192.168.14.101	NX-300	ZONE1	2	ZONE 1-2
192.168.14.101	NX-300	ZONE2	2	ZONE 1-3
192.168.14.102	NX-300	ZONE1	3	ZONE 1-4
192.168.14.102	NX-300	ZONE2	3	ZONE 1-5
192.168.14.103	NX-300	ZONE1	4	ZONE 1-6
192.168.14.103	NX-300	ZONE2	4	ZONE 1-7
192.168.14.104	NX-300	ZONE1	5	ZONE 1-8
192.168.14.104	NX-300	ZONE2	5	ZONE 2-1
192.168.14.105	NX-300	ZONE1	6	ZONE 2-2
192.168.14.105	NX-300	ZONE2	6	ZONE 2-3
192.168.14.106	NX-300	ZONE1	7	ZONE 2-4
192.168.14.106	NX-300	ZONE2	7	ZONE 2-5
192.168.14.107	NX-300	ZONE1	8	ZONE 2-6
192.168.14.107	NX-300	ZONE2	8	ZONE 2-7

### (1) NX zone priority

Sets the priority level of the broadcast output to the NX-300. (1: Emergency, 2: High to 8: Low)  
Set according to the priority levels of other broadcasts within the NX-300 system.

**Note**

This priority level differs from that in the VX-3000 system.

Available Settings	1 to 8 (default: 6)
--------------------	---------------------

### (2) VX zone

Select the VX-3000F's output zone.

Available Settings	ID and zone number of the VX-3000F registered in the Unit configuration settings
--------------------	--

## 16. SOUND SETTINGS

Clicking the Sound settings button displays the screen below.

The screenshot shows the 'VX-3000 Setting Software' window. The left sidebar contains a tree view of settings categories: Basic, System configuration, Broadcast setting, and Functional setting. The 'Sound settings' button under 'Functional setting' is highlighted with a red circle. The main content area is titled 'IN' and has sub-tabs for 'OUT' and 'ANC'. The 'OUT' tab is active, showing the following settings:

- Ch.:** Analog 0-1 (dropdown), with 'Paste', 'Copy', and 'Initialize' buttons.
- Volume:** 0 (slider).
- Filter:** A table with 3 rows and 6 columns: No., On/Off, Type, Freq. (Hz), Gain(dB), and Q.
 

No.	On/Off	Type	Freq. (Hz)	Gain(dB)	Q
1	Off	PEQ	1.00k	0.0	4.318
2	Off	PEQ	1.00k	0.0	4.318
3	Off	PEQ	1.00k	0.0	4.318
- FBS:** On/Off (Off).
- VOX:** On/Off (Off), Threshold(dB) (-20), Hysteresis(dB) (0), Hold time(msec) (2000), Related control output (None), Broadcast type (Individual zone), Broadcast zone (ZONE 0-1).
- Comp.:** On/Off (Off), Threshold(dB) (0), Ratio ( $\infty:1$ ), Knee Type (Hard), Attack time(msec) (10), Release time(msec) (500), Gain(dB) (0).

At the bottom of the main area is an 'Apply settings (PC->VX)' button.

### 16.1. Sound Settings (Input) Tab

Click the "IN" tab on the Sound settings screen.

You can make adjustment of the VX-3000F's Audio inputs (1 through 4) and RS Links (A and B).

You can make adjustment of the VX-3000PM's Audio inputs (1 through 8).

Signal processing shown in the table below can be set for each input.

Input sound source	ANC Sensor*1	Filter	FBS	VOX	Comp.	Volume
VX-3000F's Audio input 1 – 4	✓	✓	✓	✓	✓	✓
VX-3000F's RS-LINK A, B	—	✓*2	✓*2	—	✓*2	—
VX-3000PM's Audio input 1 – 8	—	—	—	✓	—	—

Figure below shows the signal processing flow.



\*1 Perform the ANC setting on the screen displayed by clicking on the ANC tab.

\*2 When the type of audio source is set to "Emergency," "Evacuate," "Alert," "Restoration," or "Emergency warning," the above signal processing is bypassed.

When bypassed, sound is output with the volume level returned to the original setting data value if the parameters have been changed by remote control, etc.

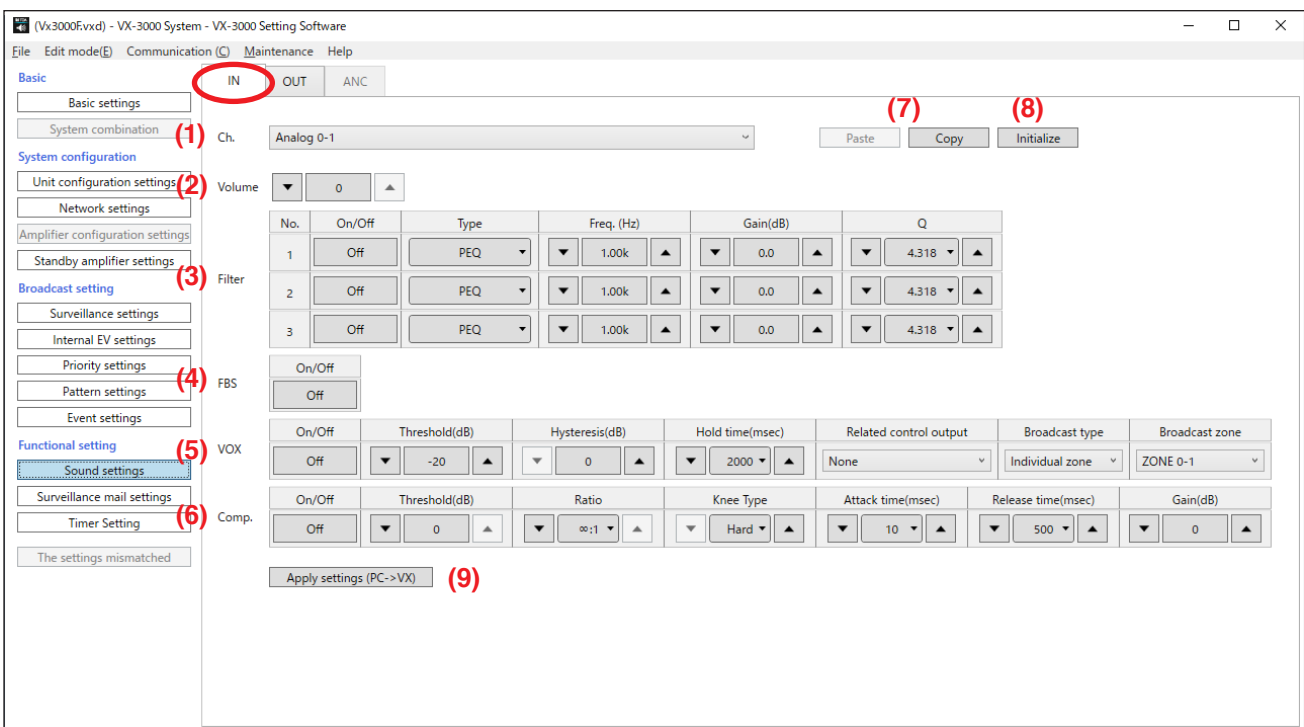

**(1) Ch.**

Click the box to select the desired Channel.

Available Settings	Name of Audio input, name of Remote microphone (default: Analog 0-1)
--------------------	--

**(2) Volume (Only when "Ch." is set to the name of Audio input)**

Set the VX-3000F's audio input volume level.

Available Settings	0 [dB] to -69 [dB] (in 1-dB steps), -∞ [dB] (default: 0 [dB])
--------------------	---

**(3) Filter**

3 kinds of filers can be set.

• **On/Off**

Available Settings	Off (default), On
--------------------	-------------------

• **Type**

Available Settings	PEQ, HPF6, LPF6, HPF12, LPF12, High Shelving, Low Shelving
--------------------	--

**[When "Type" is set to "PEQ"]**

Frequency, Gain, and Q can be set.

Click the Arrow button to select a desired value or enter a numeric value.

• **Freq.**

Available Settings	20 Hz to 20 kHz (1/24 octave steps, default: 1 kHz)
--------------------	---

• **Gain**

Available Settings	-15.0 to 15.0 dB (0.1 dB steps, default: 0 dB)
--------------------	--

• **Q**

Available Settings	0.267 – 69.249 (default: 4.318)
--------------------	---------------------------------

**[When "Type" is set to "HPF6"]**

Frequency can be set. Click the Arrow button to select a desired value or enter a numeric value.

• **Freq.**

Available Settings	20 Hz to 20 kHz (1/24 octave steps, default: 100 Hz)
--------------------	--

**[When "Type" is set to "LPF6"]**

Frequency can be set. Click the Arrow button to select a desired value or enter a numeric value.

• **Freq.**

Available Settings	20 Hz to 20 kHz (1/24 octave steps, default: 10 kHz)
--------------------	--

**[When "Type" is set to "HPF12"]**

Frequency and Q can be set. Click the Arrow button to select a desired value or enter a numeric value.

• **Freq.**

Available Settings	20 Hz to 20 kHz (1/24 octave steps, default: 100 Hz)
--------------------	--

• **Q**

Available Settings	0.500 – 2.563 (default: 0.500)
--------------------	--------------------------------

**[When "Type" is set to "LPF12"]**

Frequency and Q can be set. Click the Arrow button to select a desired value or enter a numeric value.

• **Freq.**

Available Settings	20 Hz to 20 kHz (1/24 octave steps, default: 10 kHz)
--------------------	--

• **Q**

Available Settings	0.500 – 2.563 (default: 0.500)
--------------------	--------------------------------

**[When "Type" is set to "High Shelving"]**

Frequency and Gain can be set. Click the Arrow button to select a desired value or enter a numeric value.

• **Freq.**

Available Settings	6 kHz to 20 kHz (1/24 octave steps, default: 6 kHz)
--------------------	---

• **Gain**

Available Settings	-15.0 to 15.0 dB (0.1 dB steps, default: 0 dB)
--------------------	--

**[When "Type" is set to "Low Shelving"]**

Frequency and Gain can be set. Click the Arrow button to select a desired value or enter a numeric value.

• **Freq.**

Available Settings	20 Hz to 500 Hz (1/24 octave steps, default: 500 Hz)
--------------------	--

• **Gain**

Available Settings	-15.0 to 15.0 dB (0.1 dB steps, default: 0 dB)
--------------------	--

**(4) FBS**

Set On/Off of the FBS function.

Available Settings	Off (default), On
--------------------	-------------------

**(5) VOX**

Set the VOX function.

• **On/Off**

Available Settings	Off (default), On
--------------------	-------------------

• **Threshold**

Click the Arrow button to select a desired value or enter a numeric value.

Available Settings	-60 to 0 dB (1 dB steps, default: -20 dB)
--------------------	---

• **Hysteresis**

Click the Arrow button to select a desired value or enter a numeric value.

Available Settings	0 to 10 dB (1 dB steps, default: 0 dB)
--------------------	--

• **Hold time**

Click the Arrow button to select a desired value.

Available Settings	10, 20, 50, 70, 100, 120, 150, 200, 250, 300, 500, 700, 1000, 2000, 3000, 5000, 10000 ms (default: 2000 ms)
--------------------	---

• **Related control output**

Click the Arrow button to select the control output pattern.

Available Settings	None (default), set control output pattern
--------------------	--

• **Broadcast type**

Click the Arrow button to select.

Available Settings	None, individual zone (default), Pattern
--------------------	--

• **Broadcast zone**

**[When "Broadcast type" is set to "individual zone"]**

Click the Arrow button to select the output zone name.

Available Settings	Available output zone name
--------------------	----------------------------

**[When "Broadcast type" is set to "Pattern"]**

Click the Arrow button to select the output zone pattern name.

Available Settings	Set output zone pattern name
--------------------	------------------------------

**Tip**

When the network area division function is used, the output zone pattern name is followed by an asterisk "\*" if the selected output zone pattern includes at least one zone belonging to a different network area so that broadcast cannot be output to such zone.

**(6) Comp.**

Set the Compressor function.

- **On/Off**

Available Settings	Off (default), On
--------------------	-------------------

- **Threshold**

Click the Arrow button to select a desired value or enter a numeric value.

Available Settings	-20 to 0 dB (1 dB steps, default: 0 dB)
--------------------	---

- **Ratio**

Click the Arrow button to select the Ratio.

Available Settings	1:1, 1.1:1, 1.2:1, 1.3:1, 1.5:1, 1.7:1, 2:1, 2.3:1, 2.6:1, 3:1, 4:1, 5:1, 7:1, 8:1, 10:1, 12:1, 20:1, ∞:1 (default)
--------------------	---

- **Knee Type**

Click the Arrow button to select the Knee type.

Available Settings	Hard (default), Middle, Soft
--------------------	------------------------------

- **Attack time**

Click the Arrow button to select a desired value.

Available Settings	0.2, 0.5, 0.7, 1, 1.5, 2, 3, 5, 7, 10 (default), 20, 50, 70, 100, 120, 150, 200, 250, 300, 500, 700, 1000, 2000, 3000, 5000 ms
--------------------	--

- **Release time**

Click the Arrow button to select a desired value.

Available Settings	10, 20, 50, 70, 100, 120, 150, 200, 250, 300, 500 (default), 700, 1000, 2000, 3000, 5000 ms
--------------------	---

- **Gain**

Click the Arrow button to select a desired value or enter a numeric value.

Available Settings	-∞, -69 to 10 dB (default: 0 dB)
--------------------	----------------------------------

**(7) Copy and Paste buttons**

Clicking the Copy button copies all of the on-screen settings.

Clicking the Paste button pastes the copied parameters in the same setting screen of other input channel.

**(8) Initialize button**

Returns the setting value of the channel being displayed to the initial value.

When clicked, a confirmation dialog appears. Then, click the OK button.

**(9) Apply settings (PC ->VX) button**

Applies the setting value to the VX-3000F temporarily, and you can hear the adjusted sound.

**Note**

An applied setting value returns to the original one when the VX-3000F is restarted.

Once the setting value is determined, transmit the Setting project file to the VX-3000F by selecting [Communication] → [Setting data & Audio source upload (PC->VX)] from the menu bar to reflect it to the VX-3000F.

## 16.2. Sound Settings (Output) Tab

Click the "OUT" tab on the Sound settings screen.

Sound of the zone outputs can be adjusted.

The table below shows the zone groups adjustable for sound, which differ depending on models and settings.

Model	Adjustable unit
VX-3004F	Individual zones
VX-3008F, VX-3016F	All zones in block (including the expansion unit)
VX-3016F (when in 2 channel mode)	2 groups of "Zone 1 through 8" and "Zone 9 through 16"

Signal processing shown in the table below can be set for each zone output.

Output	Volume*1	ANC*1, *2	Filter*1	Comp.*1	Delay*1
Audio output	✓	✓	✓	✓	✓

Signal processing shown in the table below can be set for each output.



\*1 When the type of audio source is set to "Emergency," "Evacuate," "Alert," "Restoration," or "Emergency warning," the above signal processing is bypassed.

When bypassed, sound is output with the volume level returned to the original setting data value if the parameters have been changed by remote control, etc.

\*2 Perform the ANC setting on the screen displayed by clicking on the ANC tab.

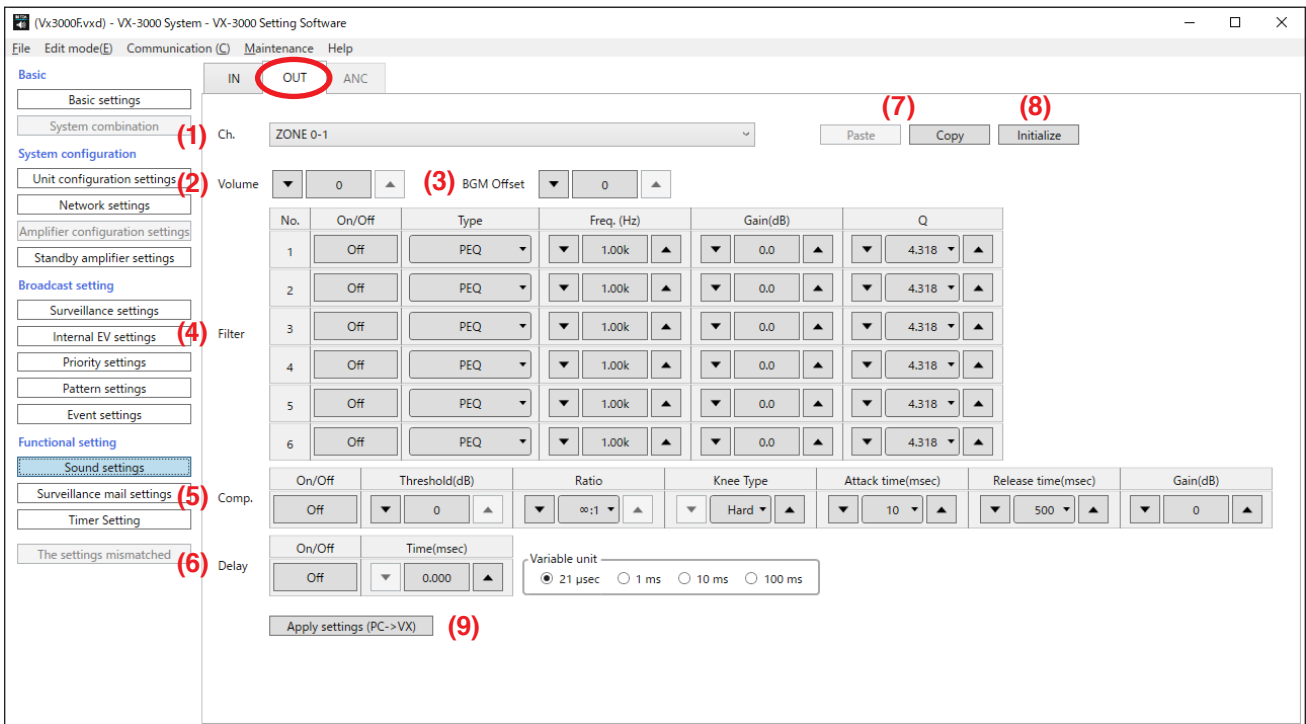

### (1) Ch.

Click the box to select the desired Channel.

Available Settings	Name of Audio output (default: ZONE 0-1)
--------------------	--

### (2) Volume

Click the Arrow button to select a desired value or enter a numeric value.

Available Settings	$-\infty$ , $-69$ to $0$ dB (1 dB steps, default: 0 dB)
--------------------	---

**(3) BGM Offset**

Set the attenuation amount of BGM volume when the Type of audio input is set to BGM.  
Click the Arrow button to select a desired value or enter a numeric value.

Available Settings	$-\infty$ , -69 to 0 dB (1 dB steps, default: 0 dB)
--------------------	---

**Note**

The sum of the value set in (2) "Volume" field and that in (3) "BGM Offset" field cannot be set to under -70 dB.

**(4) Filter**

6 kinds of filters can be set.

• **On/Off**

Available Settings	Off (default), On
--------------------	-------------------

• **Type**

Available Settings	PEQ, HPF6, LPF6, HPF12, LPF12, High Shelving, Low Shelving, All Pass, Notch, Horn EQ
--------------------	--

**[When "Type" is set to "PEQ"]**

Frequency, Gain, and Q can be set.

Click the Arrow button to select a desired value or enter a numeric value.

• **Freq.**

Available Settings	20 Hz to 20 kHz (1/24 octave steps, default: 1 kHz)
--------------------	---

• **Gain**

Available Settings	-15.0 to 15.0 dB (0.1 dB steps, default: 0 dB)
--------------------	--

• **Q**

Available Settings	0.267 – 69.249 (default: 4.318)
--------------------	---------------------------------

**[When "Type" is set to "HPF6"]**

Frequency can be set. Click the Arrow button to select a desired value or enter a numeric value.

• **Freq.**

Available Settings	20 Hz to 20 kHz (1/24 octave steps, default: 100 Hz)
--------------------	--

**[When "Type" is set to "LPF6"]**

Frequency can be set. Click the Arrow button to select a desired value or enter a numeric value.

• **Freq.**

Available Settings	20 Hz to 20 kHz (1/24 octave steps, default: 10 kHz)
--------------------	--

**[When "Type" is set to "HPF12"]**

Frequency and Q can be set. Click the Arrow button to select a desired value or enter a numeric value.

• **Freq.**

Available Settings	20 Hz to 20 kHz (1/24 octave steps, default: 100 Hz)
--------------------	--

• **Q**

Available Settings	0.500 – 2.563 (default: 0.500)
--------------------	--------------------------------

**[When "Type" is set to "LPF12"]**

Frequency and Q can be set. Click the Arrow button to select a desired value or enter a numeric value.

• **Freq.**

Available Settings	20 Hz to 20 kHz (1/24 octave steps, default: 10 kHz)
--------------------	--

• **Q**

Available Settings	0.500 – 2.563 (default: 0.500)
--------------------	--------------------------------

**[When "Type" is set to "High Shelving"]**

Frequency and Gain can be set. Click the Arrow button to select a desired value or enter a numeric value.

• **Freq.**

Available Settings	6 kHz to 20 kHz (1/24 octave steps, default: 6 kHz)
--------------------	---

• **Gain**

Available Settings	–15.0 to 15.0 dB (0.1 dB steps, default: 0 dB)
--------------------	--

**[When "Type" is set to "Low Shelving"]**

Frequency and Gain can be set. Click the Arrow button to select a desired value or enter a numeric value.

• **Freq.**

Available Settings	20 Hz to 500 Hz (1/24 octave steps, default: 500 Hz)
--------------------	--

• **Gain**

Available Settings	–15.0 to 15.0 dB (0.1 dB steps, default: 0 dB)
--------------------	--

**[When "Type" is set to "All Pass"]**

Frequency and Q can be set. Click the Arrow button to select a desired value or enter a numeric value.

• **Freq.**

Available Settings	20 Hz to 20 kHz (1/24 octave steps, default: 1 kHz)
--------------------	---

• **Q**

Available Settings	0.267 – 69.249 (default: 0.267)
--------------------	---------------------------------

**[When "Type" is set to "Notch"]**

Frequency and Q can be set. Click the Arrow button to select a desired value or enter a numeric value.

• **Freq.**

Available Settings	20 Hz to 20 kHz (1/24 octave steps, default: 1 kHz)
--------------------	---

• **Q**

Available Settings	8.651 – 69.249 (default: 8.651)
--------------------	---------------------------------

**[When "Type" is set to "Horn EQ"]**

Gain can be set. Click the Arrow button to select a desired value or enter a numeric value.

• **Gain**

Available Settings	0.0 to 18.0 dB (0.5 dB steps, default: 0.0 dB)
--------------------	--

**(5) Comp.**

Set the Compressor function.

• **On/Off**

Available Settings	Off (default), On
--------------------	-------------------

• **Threshold**

Click the Arrow button to select a desired value or enter a numeric value.

Available Settings	–20 to 0 dB (1 dB steps, default: 0 dB)
--------------------	---

- **Ratio**

Click the Arrow button to select the Ratio.

Available Settings	1:1, 1.1:1, 1.2:1, 1.3:1, 1.5:1, 1.7:1, 2:1, 2.3:1, 2.6:1, 3:1, 4:1, 5:1, 7:1, 8:1, 10:1, 12:1, 20:1, ∞:1 (default)
--------------------	---

- **Knee Type**

Click the Arrow button to select the Knee type.

Available Settings	Hard (default), Middle, Soft
--------------------	------------------------------

- **Attack time**

Click the Arrow button to select a desired value.

Available Settings	0.2, 0.5, 0.7, 1, 1.5, 2, 3, 5, 7, 10 (default), 20, 50, 70, 100, 120, 150, 200, 250, 300, 500, 700, 1000, 2000, 3000, 5000 ms
--------------------	--

- **Release time**

Click the Arrow button to select a desired value.

Available Settings	10, 20, 50, 70, 100, 120, 150, 200, 250, 300, 500 (default), 700, 1000, 2000, 3000, 5000 ms
--------------------	---

- **Gain**

Click the Arrow button to select a desired value or enter a numeric value.

Available Settings	$-\infty$ , $-69$ to $10$ dB (default: $0$ dB)
--------------------	--

## (6) Delay

Set the Delay function.

- **On/Off**

Available Settings	Off (default), On
--------------------	-------------------

- **Time**

Click the Arrow button to select a desired value or enter a numeric value.

Available Settings	0.000 msec – 2730.646 msec (0.021-msec steps, default: 0.000 msec)
--------------------	--

- **Variable unit**

Selects the minimum units of the delay time that can be changed with the Arrow buttons.

Available Settings	21 $\mu$ sec (default), 1 ms, 10 ms, 100 ms
--------------------	---

## (7) Copy and Paste buttons

Clicking the Copy button copies all of the on-screen settings.

Clicking the Paste button pastes the copied parameters in the same setting screen of other output channel.

## (8) Initialize button

Returns the setting value of the channel being displayed to the initial value.

When clicked, a confirmation dialog appears. Then, click the OK button.

## (9) Apply settings (PC->VX) button

Applies the setting value to the VX-3000F temporarily, and you can hear the adjusted sound.

**Note**

An applied setting value returns to the original one when the VX-3000F is restarted.

Once the setting value is determined, transmit the Setting project file to the VX-3000F by selecting [Communication] → [Setting data & Audio source upload (PC->VX)] from the menu bar to reflect it to the VX-3000F.

## 16.3. Sound Settings (ANC) Tab

Click the "ANC" tab on the Sound settings screen.  
Perform settings for the output side of the ANC function.

### Note

The ANC tab is displayed only when the ANC has been set in the VX-3000F's "Unit configuration settings."

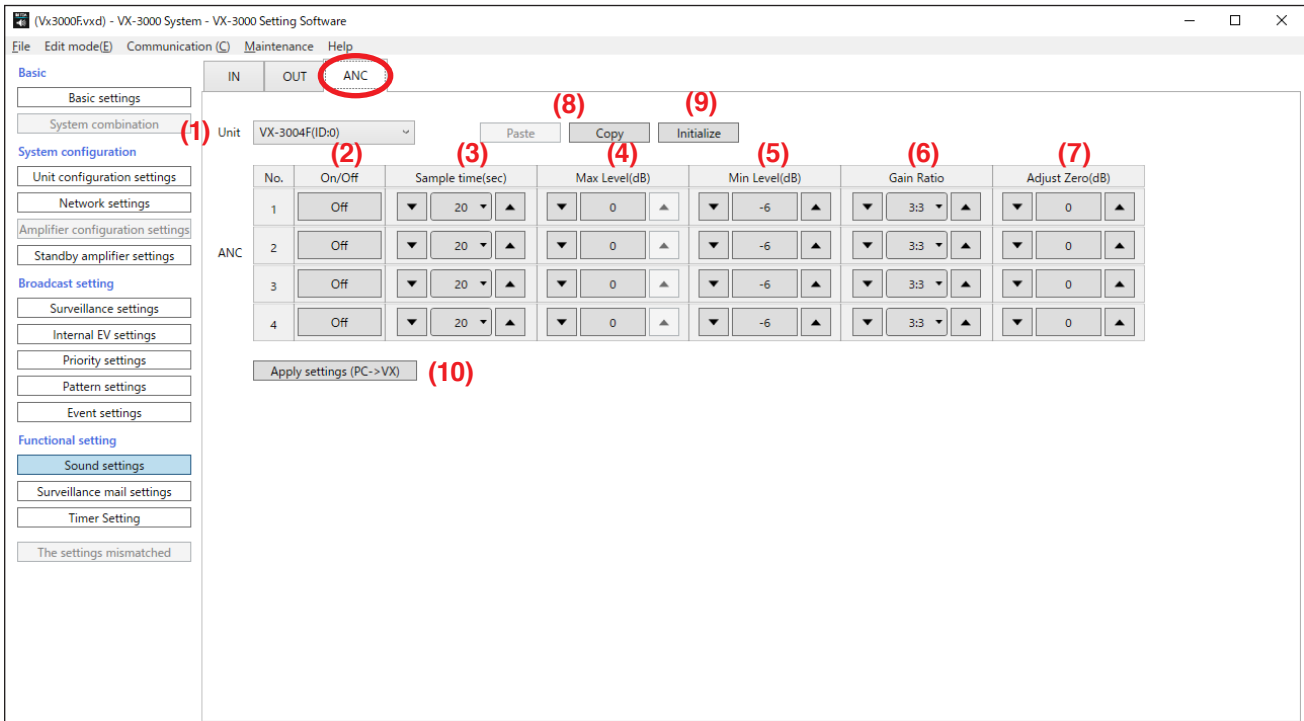

#### (1) Unit

Click on the box to select the desired VX-3000F.

#### (2) ON/OFF

Sets ON or OFF of the ANC function.

Available Settings	OFF (default), ON
--------------------	-------------------

#### (3) Sample time

Set the average time required to detect the ambient noise levels with the sensor microphone.  
The shorter this time, the quicker the output sound level follows the change of ambient noise level.  
Click the Arrow button to select a desired value.

Available Settings	10, 20 (default), 30, 60, 300 sec
--------------------	-----------------------------------

#### (4) Max Level

Set the maximum output level. Click the Arrow button to select a desired value or enter a numeric value.

Available Settings	-15 to 0 dB (1 dB steps, default: 0 dB)
--------------------	---

#### (5) Min Level

Set the minimum output level. Click the Arrow button to select a desired value or enter a numeric value.

Available Settings	-18 to (max level - 3) dB (1 dB steps, default: -6 dB)
--------------------	--

#### (6) Gain Ratio

Sets the ratio of ambient noise level variation to output level variation in the form of "Ambient noise level variation : Output level variation."

For example, if the ratio is set to be 3:3, the output volume level goes up by 3 dB when the ambient noise level increases by 3 dB.

Click the Arrow button to select.

Available Settings	6:3, 5:3, 4:3, 3:3 (default), 3:4, 3:5, 3:6
--------------------	---

**(7) Adjust Zero**

Normally use the default value.

When wishing to adjust the reference level, click the Arrow buttons to select a desired value or enter a numeric value.

Available Settings	-60 to 60 dB (1 dB steps, default: 0 dB)
--------------------	--

**(8) Copy and Paste buttons**

Clicking the Copy button copies all of the on-screen settings.

Clicking the Paste button pastes the copied parameters in the same setting screen of other VX-3000F unit.

**(9) Initialize button**

Returns the setting value of the ANC function set to the unit being displayed to the initial value.

When clicked, a confirmation dialog appears. Then, click the OK button.

**(10) Apply settings (PC->VX) button**

Applies the setting value to the VX-3000F temporarily, and you can hear the adjusted sound.

**Notes**

- An applied setting value returns to the original one when the VX-3000F is restarted.  
Once the setting value is determined, transmit the Setting project file to the VX-3000F by selecting [Communication] → [Setting data & Audio source upload (PC->VX)] from the menu bar to reflect it to the VX-3000F.
- If you click the "Apply settings (PC->VX)" button while the operations regarding the ANC setting shown below are being activated by the operation on the Maintenance screen, such operations will stop. (See p. 3-202.)
  - During reference level measurement
  - During application of Max level
  - During application of Min level

## 17. SURVEILLANCE MAIL SETTINGS

The surveillance mail settings button becomes active when "Setting for fault detect functions" is set to "Used" on the Basic setting screen.

Clicking the Surveillance mail settings button displays the Surveillance mail setting screen.

You can set the function to send an e-mail notification when a failure has occurred or has been reset within the VX-3000 system.

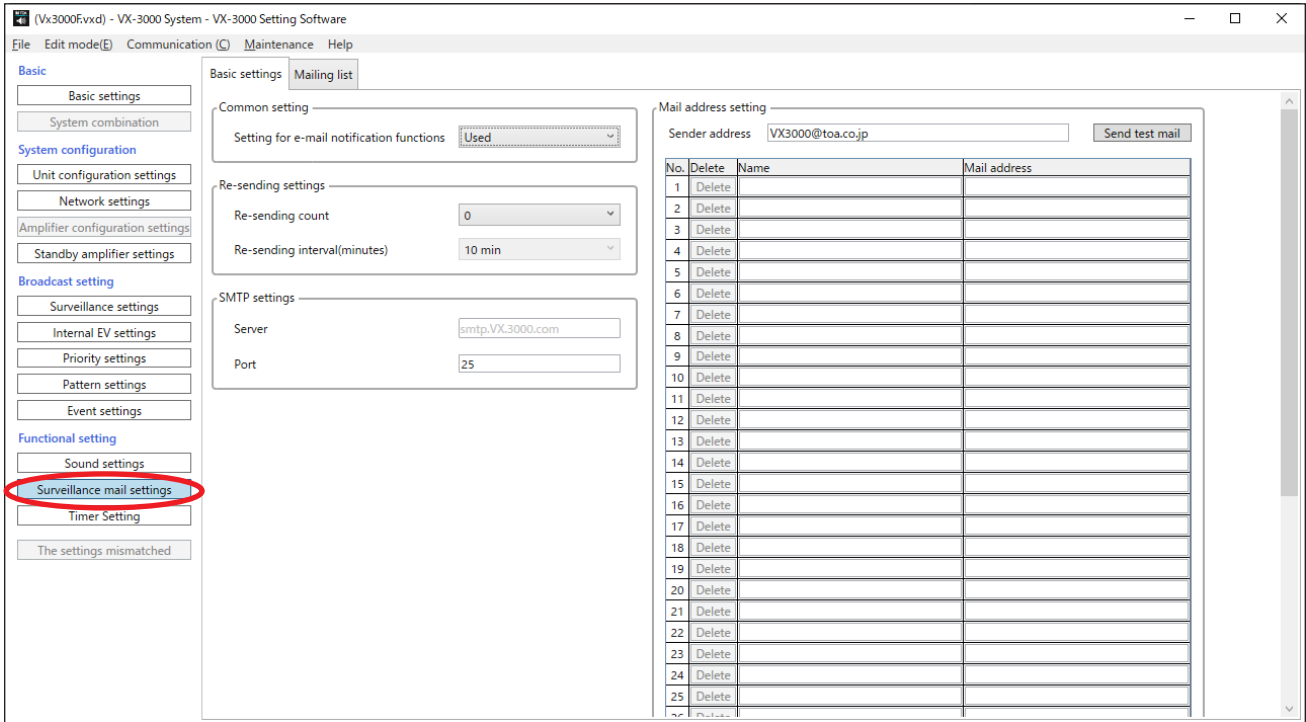

- The e-mail notification about failure occurrence is sent 100 seconds after the earliest failure has occurred.
- When 2 or more same failure patterns occur or are reset within 100 seconds, their notifications are collectively sent by a single e-mail.

### [E-mail sentence examples]

Subject:[VX-3000]Failure Notification 0001

Sent date:2017/01/01 13:00:00

Transmission success or failure:success

↑ Surveillance pattern number

\*\*\*\*\* MailBody \*\*\*\*\*

↓ Details of the failure occurrence or failure reset

(Date and time of failure occurrence, fault location, fault contents, etc.)

No.0001	2017/01/01 12:00:00	Failure output pattern 0001	: Warning	
VX(ID:000)		ANALOG LINK	ANALOG-LINK	Occurrence
No.0002	2017/01/01 12:00:10	Failure output pattern 0001	: Normal	
VX(ID:000)		ANALOG LINK	ANALOG-LINK	Restoration
No.0003	2017/01/01 12:00:20	Failure output pattern 0001	: Warning	
VX(ID:000)	RM(ID:00)	RS LINK	Connection abnormal	Occurrence
No.0004	2017/01/01 12:00:30	Failure output pattern 0001	: Warning	
VX(ID:000)		Line	Open	1 Occurrence

## 17.1. Basic Settings

Clicking the Basic settings tab on the Surveillance mail settings screen displays the screen below.

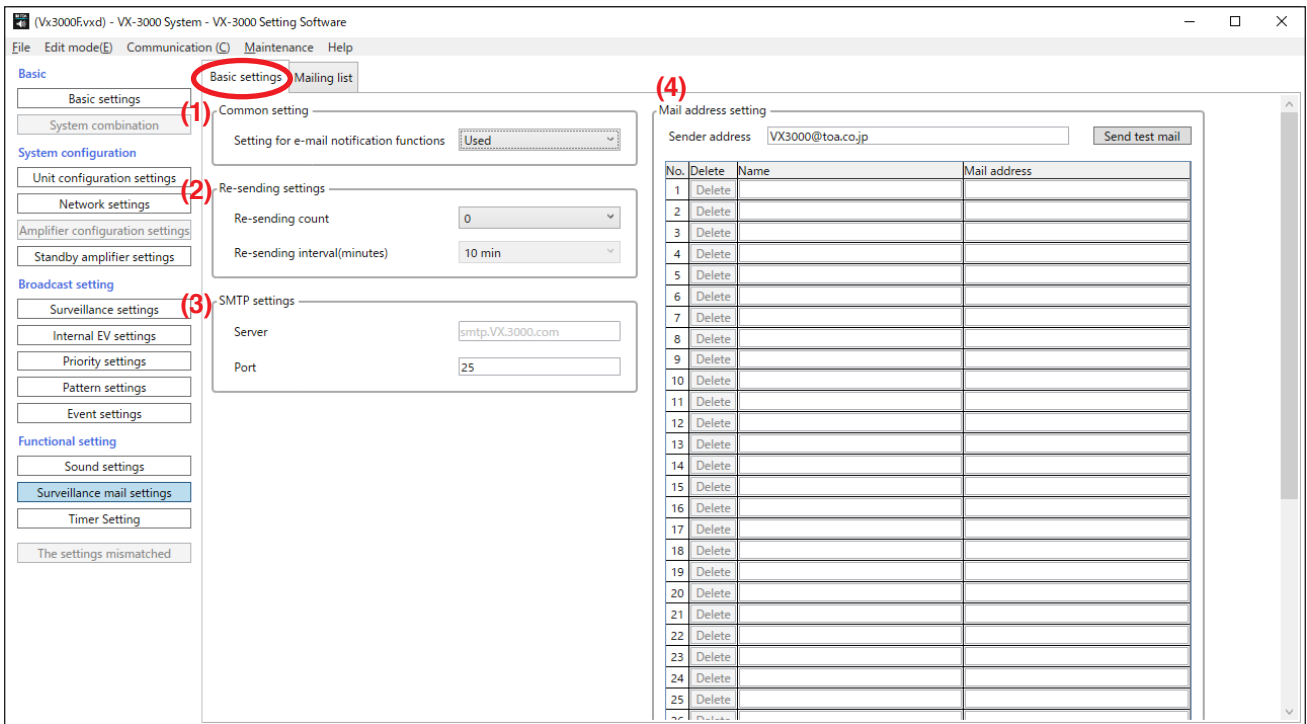

### (1) Common setting

- **Setting for e-mail notification functions**

Set whether or not to use the function to notify the failure occurrence and failure reset by e-mail.

When set to "Not used," e-mail notifications are not created and access to the server is not allowed.

When set to "Used," other setting items shown on the Surveillance mail settings screen become valid.

Available Settings	Not used (default), used
--------------------	--------------------------

### (2) Re-sending settings

- **Re-sending count**

Set the number of resending operations when e-mail send fails.

Available Settings	0 (default), 1 – 10
--------------------	---------------------

- **Re-sending interval (minutes)**

If you set the "Re-sending count" to any one between "1" and "10," setting for this item becomes valid.

Available Settings	10 min (default), 30 min, 60 min, 120 min, 240 min, 480 min
--------------------	---

### (3) SMTP settings

- **Server**

Enter the SMTP server's URL\* or IP address.

\* The label length must be up to 63 characters and the total URL length up to 253 characters.

- **Port**

Enter the SMTP's port number. (Default: 25)

**Note**

The VX-3000 does not support the mail server that uses encrypted communication.

#### (4) Mail address setting

- **Sender address**

Set the e-mail address of the transmission source. The VX-3000F set to ID "0" becomes a transmission source.

- **[Send test mail] button**

If you click this button, a test e-mail will be sent to all the destination addresses registered in the mailing address list from the VX-3000 Setting software.

- **Mail address list**

Up to 40 destination e-mail addresses can be registered in this list.

Enter the destination name and e-mail address.

The Delete button becomes active when they are entered. Clicking the Delete button deletes the name and e-mail address.

#### Note

When setting the e-mail address, the local part (the part before the @ symbol) and the label must be up to 63 characters long each and the total address up to 128 characters long.

## 17.2. Mailing List Settings

Clicking the Mailing list tab on the Surveillance mail setting screen displays the screen below. Up to 40 groups can be set as e-mail destinations.

As the e-mail addresses registered in the Basic settings are listed, select 2 or more e-mail addresses from the list to set up a destination group.

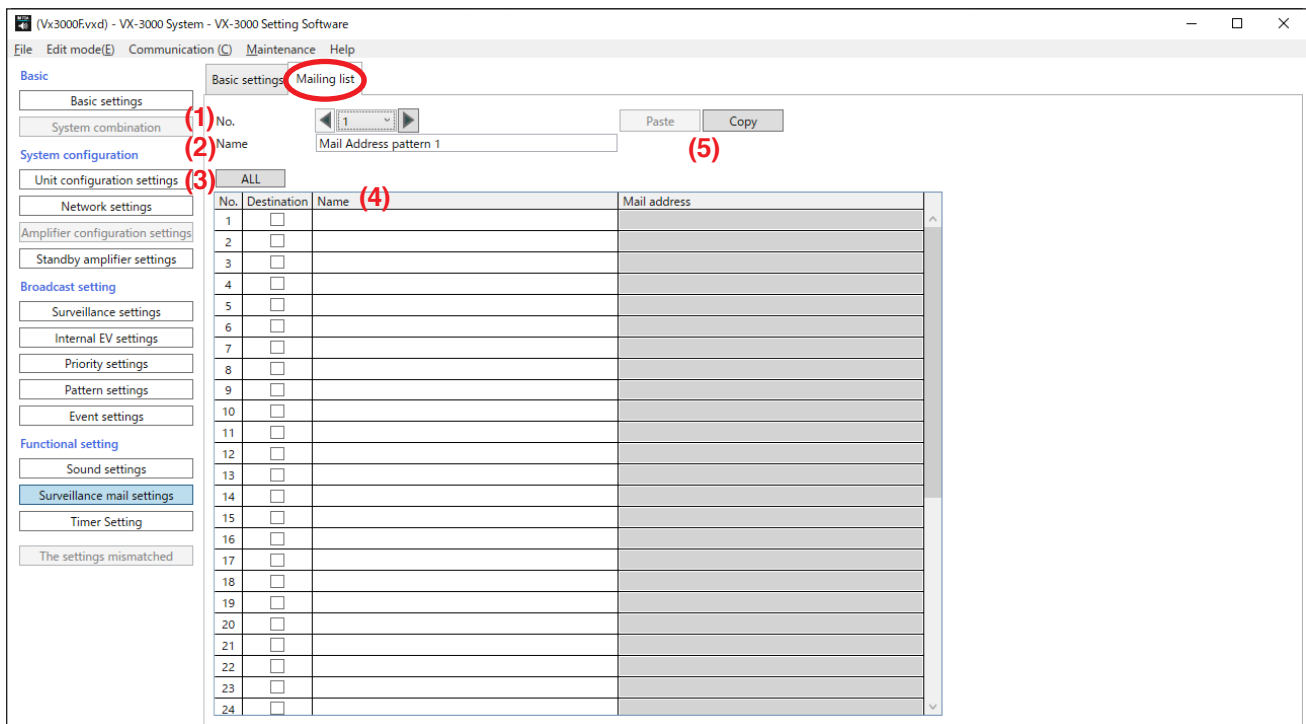

#### (1) No.

Click the box or arrow buttons to select the number.

Available Settings	1 – 40 (default: 1)
--------------------	---------------------

#### (2) Name

Enter the name of the Mailing list.

Available Settings	Up to 32 alphanumeric characters (default: Mail Address Pattern 1 – 40)
--------------------	---

#### (3) All button

Allows all e-mail destination checkboxes to be simultaneously selected or unselected.

**(4) Destination checkbox**

Mark the checkbox for the e-mail address to set as destination.

**(5) Copy and Paste buttons**

Clicking the Copy button copies all of the on-screen settings except "Name" (2) preset by default.

Select another mailing list number. Then, clicking the Paste button pastes the copied parameters in the setting screen of the selected "No." (1).

## 18. TIMER SETTING

When the Timer Setting button is clicked, the screen below is displayed.

Event such as General broadcast pattern and Base broadcast pattern can be activated at the preset time.

Up to 10 types of daily event schedules can be registered as daily programs, and weekly programs and holiday programs can be created by assigning these daily programs to each day of the week and up to 50 holiday periods.

Concerning the timer setting, only the data on the timer setting can be changed without reactivating the VX-3000 Setting software during operation by selecting [Communication] → [Timer setting upload (PC->VX)] from the menu bar.

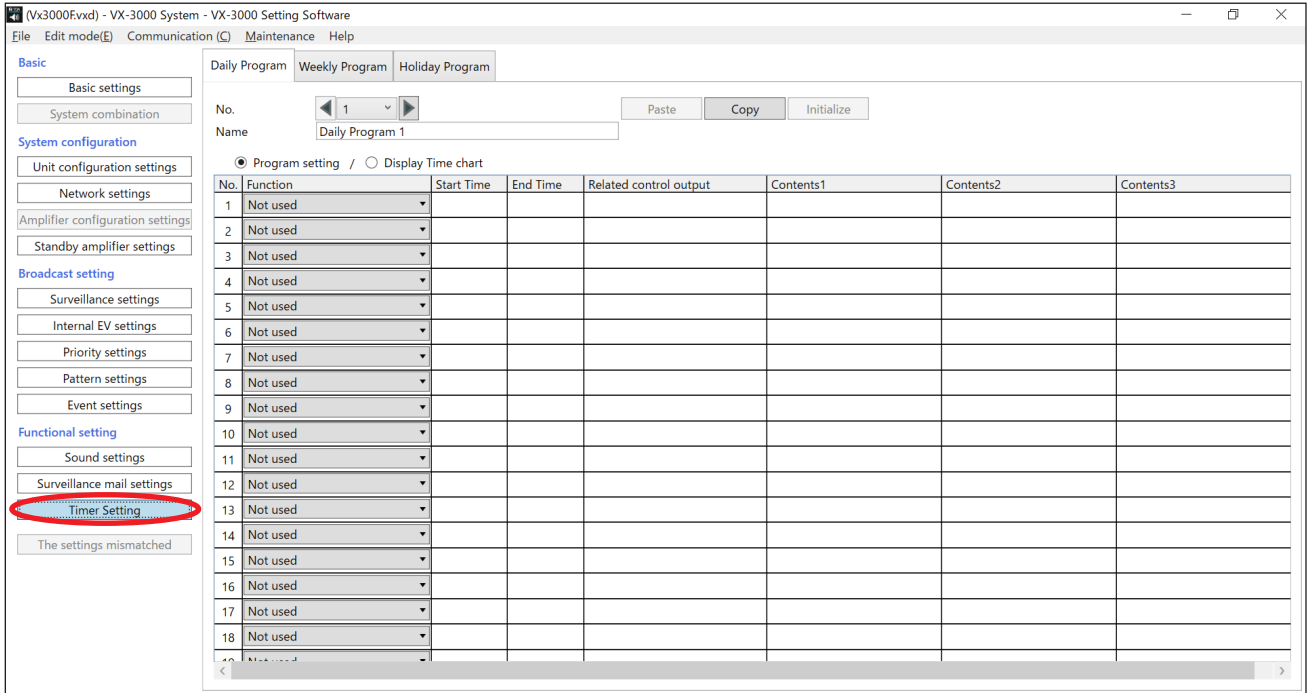

### 18.1. Registering the Daily Program

When the Daily Program tab is clicked, the screen below is displayed.

Register as many daily event schedules as needed. Up to 10 types of schedules can be registered.

Registering the daily program allows the weekly program and the holiday program to be created.

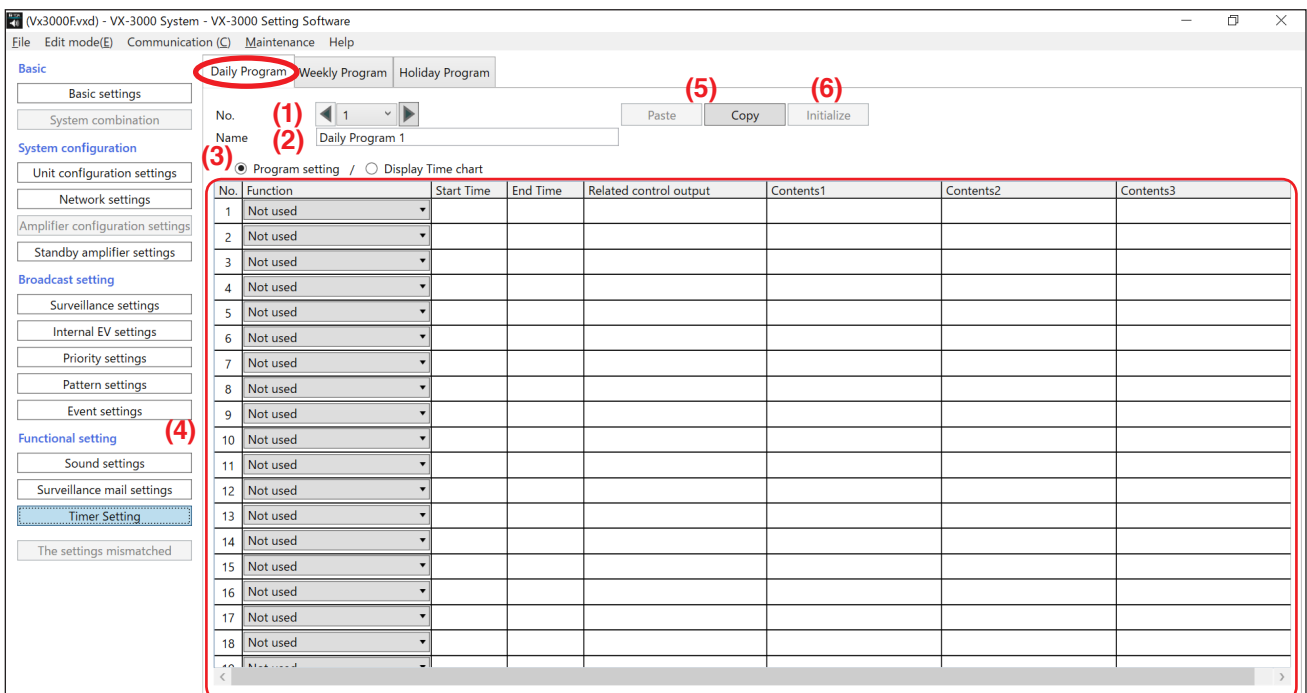

**(1) No.**

Click the box or arrow buttons to select the number of the daily program.

Available Settings	1 – 10 (default: 1)
--------------------	---------------------

**(2) Name**

Enter the name of the daily program.

Available Settings	Up to 32 alphanumeric characters (default: Daily Program 1 – 10)
--------------------	--

**(3) Display selection button**

Selects the display.

Perform settings on the screen displayed when "Program setting" is selected.

If you switch the display to "Display Time chart," duration between "Start Time" and "End Time" for each programmed schedule will be displayed in a bar graph.

[Example when "Program setting" is selected]

No.	Function	Start Time	End Time	Related control output	Contents1	Contents2	Contents3
1	Activate base broadcast pattern	09:00:00		None	Base pattern 1		
2	Zone volume attenuation(Level)	19:00:00	24:00:00		-10 [dB]	Pattern	Zone pattern 1
3	Not used						
4	Not used						
5	Not used						
6	Not used						
7	Not used						
8	Not used						
9	Not used						
10	Not used						
11	Not used						
12	Not used						
13	Not used						
14	Not used						
15	Not used						
16	Not used						
17	Not used						
18	Not used						

[Example when "Display Time chart" is selected]

No.	Function	Start Time	End Time	6:00	12:00	18:00
1	Activate base broadcast pattern	09:00:00				
2	Zone volume attenuation(Level)	19:00:00	24:00:00			
3	Not used					
4	Not used					
5	Not used					
6	Not used					
7	Not used					
8	Not used					
9	Not used					
10	Not used					
11	Not used					
12	Not used					
13	Not used					
14	Not used					
15	Not used					
16	Not used					
17	Not used					
18	Not used					
19	Not used					
20	Not used					
21	Not used					

**(4) Function, Start Time, End Time, Related control output, Contents 1, Contents 2, Contents 3**

Click the box or the arrow button for each item to select the setting content.

Enter a numeric value in the start time and the end time fields.

The table below shows the selectable functions. Selectable items differ depending on the selected function.

✓ : Settable, – : No need to set

Function	Start Time	End Time	Related control output	Contents 1	Contents 2	Contents 3
Activate general broadcast pattern	✓	✓	✓	✓	–	–
Activate base broadcast pattern	✓	–	✓	✓	–	–
Interrupt base broadcast pattern	✓	–	–	–	–	–
Zone volume adjustment (Pulse)	✓	–	–	✓	✓	✓
Zone volume attenuation (Level)	✓	✓	–	✓	✓	✓
Intended control output operation (Pulse)	✓	–	–	✓	–	–
Intended control output operation (Level)	✓	✓	–	✓	–	–

**[If "Activate general broadcast pattern" is selected for "Function"]****• Start Time, End Time**

Enter General broadcast pattern start and end times.

**Tips**

- The end time must be later than the start time.
- If you wish to continue the broadcast exceeding 24:00:00, register the daily program of which end time is at 24:00:00 and another daily program of which start time is at 00:00:00, then combine both programs to use in the weekly program or the holiday program.

Available Settings	00:00:00 (default) – 24:00:00
--------------------	-------------------------------

**• Related control output**

Selects the control output pattern which operates in synchronization with the general broadcast pattern activation.

Select "Pattern setting" → "Control output pattern setting" (p. 3-100) to set a control output pattern.

Available Settings	None (default), Set control output pattern
--------------------	--

**• Contents 1**

Selects the general broadcast pattern to be activated at the specified time.

Select "Pattern setting" → "General broadcast pattern setting" (p. 3-98) to set a control output pattern.

Available Settings	None (default), Set general broadcast pattern
--------------------	---

**[If "Activate base broadcast pattern" is selected for "Function"]****• Start Time**

Enter the base broadcast pattern start time.

Available Settings	00:00:00 (default) – 24:00:00
--------------------	-------------------------------

**• Related control output**

Selects the control output pattern which operates in synchronization with the base broadcast pattern activation.

Select "Pattern settings" → "Control output pattern setting" (p. 3-100) to set a control output pattern.

Available Settings	None (default), Set control output pattern
--------------------	--

**• Contents 1**

Selects the base broadcast pattern to be activated at the specified time.

Select "Pattern settings" → "Base pattern setting" (p. 3-96) to set a control output pattern.

Available Settings	None (default), Set base broadcast pattern
--------------------	--

**[If "Interrupt base broadcast pattern" is selected for "Function"]****• Start Time**

Enter the base broadcast pattern end time.

Available Settings	00:00:00 (default) – 24:00:00
--------------------	-------------------------------

**[If "Zone volume adjustment (Pulse)" is selected for "Function"]****• Start Time**

Enter the zone volume adjustment start time.

Available Settings	00:00:00 (default) – 24:00:00
--------------------	-------------------------------

**• Contents 1**

Adjust the amount to increase or decrease the sound volume level of the output zone pattern.

Available Settings	–10 to +10 dB (except 0 dB) (default: +1 dB), in 1-dB steps
--------------------	---

**• Contents 2**

Select either the VX-3000F's individual zone or the output zone pattern to determine the zone of which volume level is controlled.

Available Settings	Individual zone, Pattern (default)
--------------------	------------------------------------

**• Contents 3****[When "Contents 2" is set to "Individual zone"]**

Select the VX-3000F's output zone (individual).

Available Settings	Set output zone (individual)*
--------------------	-------------------------------

\* The volume level of all zones assigned to the target model is controlled when the VX-3008F's or VX-3016F's zones are included.

If the VX-3016F is set in 2-channel mode, the volume level of zones 1 through 8 is controlled when these zones are included, and that of zones 9 through 16 is controlled when these zones are included.

**[When "Contents 2" is set to "Pattern"]**

Select the output zone pattern.

Set the output zone pattern by selecting "Pattern settings → Output zone pattern setting" (p. 3-93).

Available Settings	Set output zone pattern*
--------------------	--------------------------

\* The volume level of all zones assigned to the target model is controlled when the VX-3008F's or VX-3016F's zones are included.

If the VX-3016F is set in 2-channel mode, the volume level of zones 1 through 8 is controlled when these zones are included, and that of zones 9 through 16 is controlled when these zones are included.

**[If "Zone volume attenuation (Level)" is selected for "Function"]****• Start Time, End Time**

Enter the zone volume attenuation start and end times.

**Tips**

- The end time must be later than the start time.
- If you wish to keep the zone volume attenuation (Level) exceeding 24:00:00, register the daily program of which end time is at 24:00:00 and another daily program of which start time is at 00:00:00, then combine both programs to use in the weekly program or the holiday program.

Available Settings	00:00:00 (default) – 24:00:00
--------------------	-------------------------------

**• Contents 1**

Select the attenuation level.

Available Settings	–1 dB, –2 dB, –3 dB, –6 dB, –10 dB (default), –20 dB, –40 dB, –∞ dB
--------------------	---

**• Contents 2**

Select either the VX-3000F's individual zone or the output zone pattern to determine the zone of which volume level is decreased.

Available Settings	Individual zone, Pattern (default)
--------------------	------------------------------------

### • Contents 3

#### [When "Contents 2" is set to "Individual zone"]

Select the VX-3000F's output zone (individual).

Available Settings	Set output zone (individual)*
--------------------	-------------------------------

\* The volume level of all zones assigned to the target model is controlled when the VX-3008F's or VX-3016F's zones are included.

If the VX-3016F is set in 2-channel mode, the volume level of zones 1 through 8 is controlled when these zones are included, and that of zones 9 through 16 is controlled when these zones are included.

#### [When "Contents 2" is set to "Pattern"]

Select the output zone pattern.

Set the output zone pattern by selecting "Pattern settings → Output zone pattern setting" (p. 3-93).

Available Settings	Set output zone pattern*
--------------------	--------------------------

\* The volume level of all zones assigned to the target model is controlled when the VX-3008F's or VX-3016F's zones are included.

If the VX-3016F is set in 2-channel mode, the volume level of zones 1 through 8 is controlled when these zones are included, and that of zones 9 through 16 is controlled when these zones are included.

### [If "Intended control output operation (Pulse)" is selected for "Function"]

#### • Start Time

Enter the control output start time.

Available Settings	00:00:00 (default) – 24:00:00
--------------------	-------------------------------

#### • Contents 1

Select the Control output pattern to control.

Set the control output pattern by selecting "Pattern settings → Control output pattern setting" (p. 3-100).

Available Settings	Set control output pattern
--------------------	----------------------------

### [If "Intended control output operation (Level)" is selected for "Function"]

#### • Start Time, End Time

Enter the control output start and end times.

Available Settings	00:00:00 (default) – 24:00:00
--------------------	-------------------------------

#### Tips

- The end time must be later than the start time.
- If you wish to continue an Intended control output operation (Level) exceeding 24:00:00, register the daily program of which end time is at 24:00:00 and another daily program of which start time is at 00:00:00, then combine both programs to use in the weekly program or the holiday program.

#### • Contents 1

Select the Control output pattern to control.

Set the control output pattern by selecting "Pattern settings → Control output pattern setting" (p. 3-100).

Available Settings	Set control output pattern
--------------------	----------------------------

### (5) Copy and Paste buttons

Clicking the Copy button copies all of the on-screen settings except the names preset by default.

Select another daily program number. Then, clicking the Paste button pastes the copied parameters in the setting screen of the selected by "No." (1).

### (6) Initialize button

Returns all setting values for the displayed daily program number to the default values.

When this button is clicked, a confirmation dialog is displayed. Click the OK button.

## 18.2. Creating a Weekly Program

When the Weekly Program tab is clicked, the screen below is displayed.

Assign the daily program registered on the daily program screen (p. 3-162) to each day of the week. The weekly program operates according to the VX-3000F's internal clock (p. 3-174).

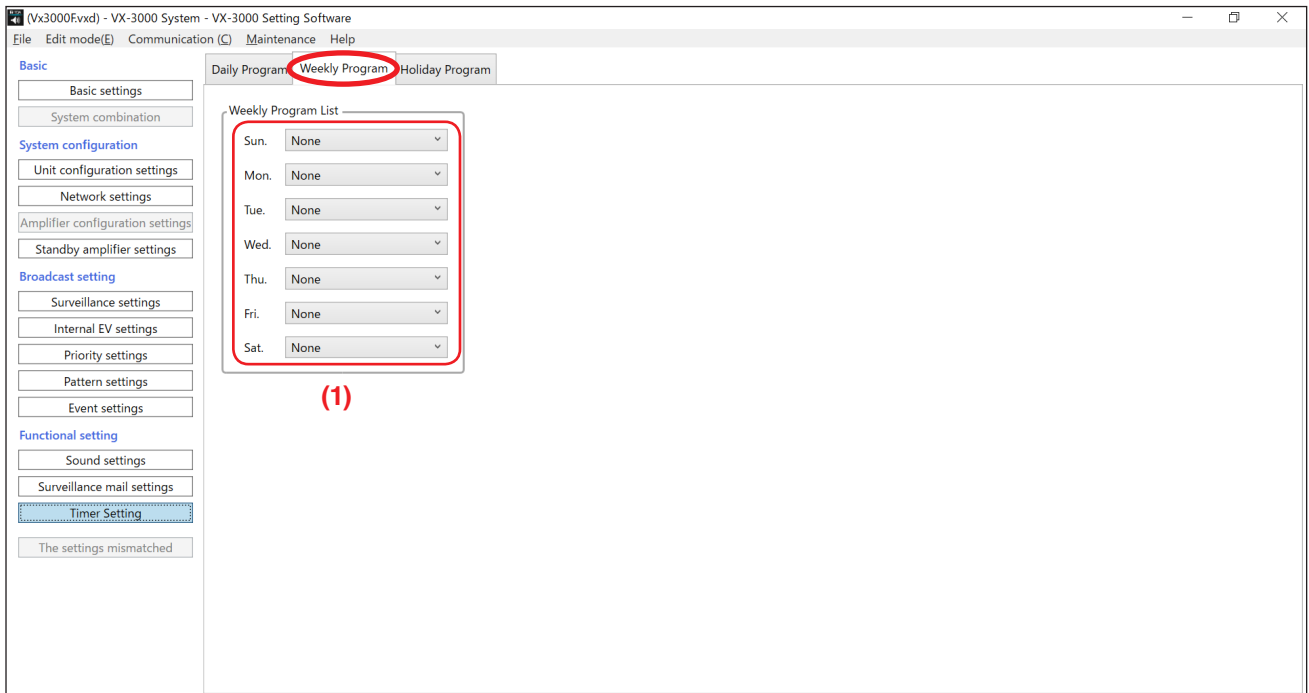

### (1) Sun., Mon., Tue., Wed., Thu., Fri., Sat.

Click the box or arrow buttons to select the daily program.

Available Settings	None (default), Set Daily Program
--------------------	-----------------------------------

### 18.3. Creating a Holiday Program

When the Holiday Program tab is clicked, the screen below is displayed.

Create this program if you want to have a program different from the weekly program for specific days such as holidays and a summer vacation period.

The holiday program operates according to the VX-3000F's internal clock (p. 3-174).

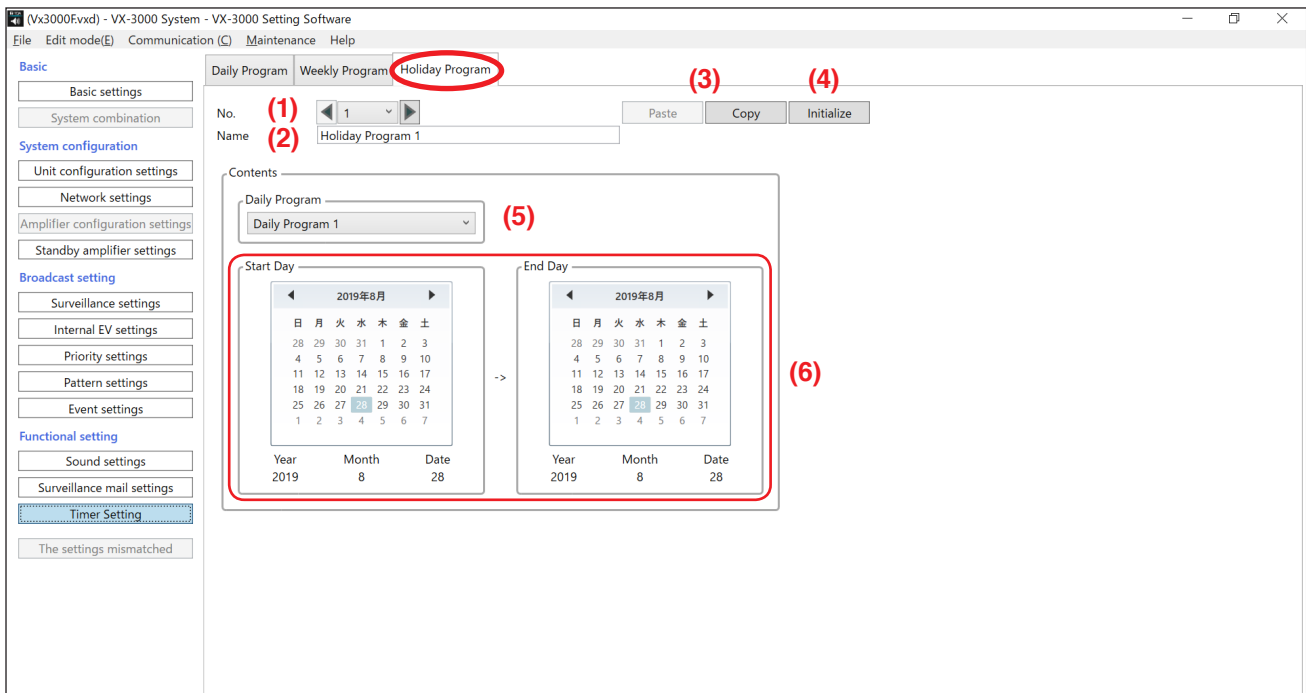

#### (1) No.

Click the box or arrow buttons to select the number of the holiday program.

Available Settings	1 – 50 (default: 1)
--------------------	---------------------

#### (2) Name

Enter the name of the holiday program.

Available Settings	Up to 32 alphanumeric characters (default: Holiday Program 1 – 50)
--------------------	--

#### (3) Copy and Paste buttons

Clicking the Copy button copies all of the on-screen settings except the names preset by default.

Select another holiday program number. Then, clicking the Paste button pastes the copied parameters in the setting screen of the selected by "No." (1).

#### (4) Initialize button

Returns all setting values for the displayed holiday program number to the default values.

When this button is clicked, a confirmation dialog is displayed. Click the OK button.

#### (5) Daily Program

Click the box or arrow buttons to select the daily program.

Available Settings	None (default), Set Daily Program
--------------------	-----------------------------------

#### (6) Start Day, End Day

Select the start and end days of the holiday program from calendar.

##### Tips

- The end day must be later than the start day.
- If you attempt to set the end day before the PC's day, "Expired" indication will be displayed in the "No." (1) field.

## 19. CONFIRMING DISCREPANCIES IN SET DATA

The [The settings mismatched] button flashes red ( **The settings mismatched** ) if there is any error in the setting content. Clicking the [The settings mismatched] button displays the following screen and you can confirm the error point.

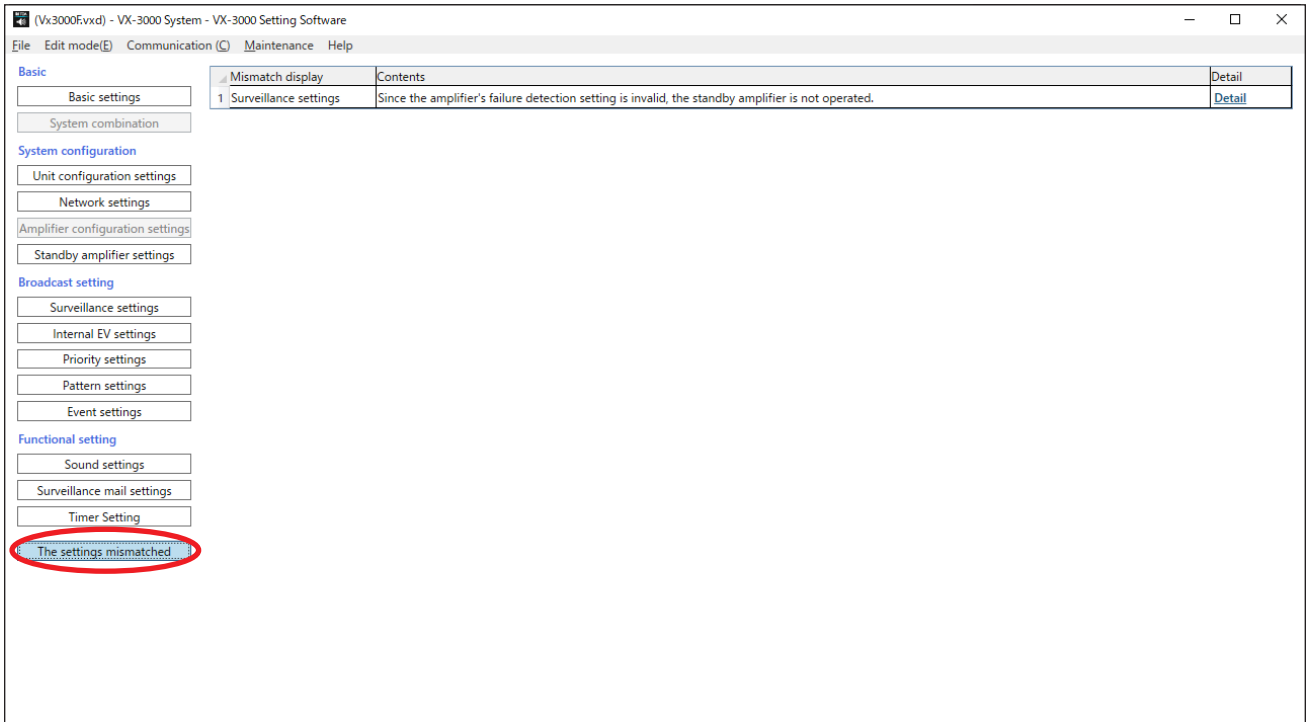

### (1) Mismatch display

Displays the setting screen with the setting error.

### (2) Contents

Displays the setting error contents.

### (3) Detail

If clicked, a dialog shown below will be displayed.

The dialog box displays the following table:

Mismatch display	Standby amplifier connect	Equipment ID	CH.	Correction
Surveillance settings	VX-3004F(ID:0)	VX-3004F(ID:0)	1	Jump
Surveillance settings	VX-3008F(ID:1)	VX-3008F(ID:1)	1	Jump

#### • Jump

Clicking the [Jump] button located at right on each line switches the display to the setting screen with the setting error. Check the set content and correct the error.

## 20. MAINTENANCE

Selecting the [Maintenance] → [Maintenance] from the menu bar displays the Maintenance screen.

Not only does this screen allow logs to be acquired online, it can also display the following: log files, unit status, broadcast statuses, and terminal statuses.

### Note

To carry out functions other than log file displays, communications must be established between the VX-3000F and the PC in advance. For details, see [p. 3-172](#).

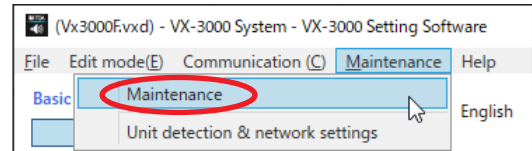

### 20.1. Maintenance Screen

Item buttons are located in the left side portion of the screen.

Clicking on each item button displays the corresponding screen in the main area in the right side portion of the setting item buttons.

Setting Item Buttons

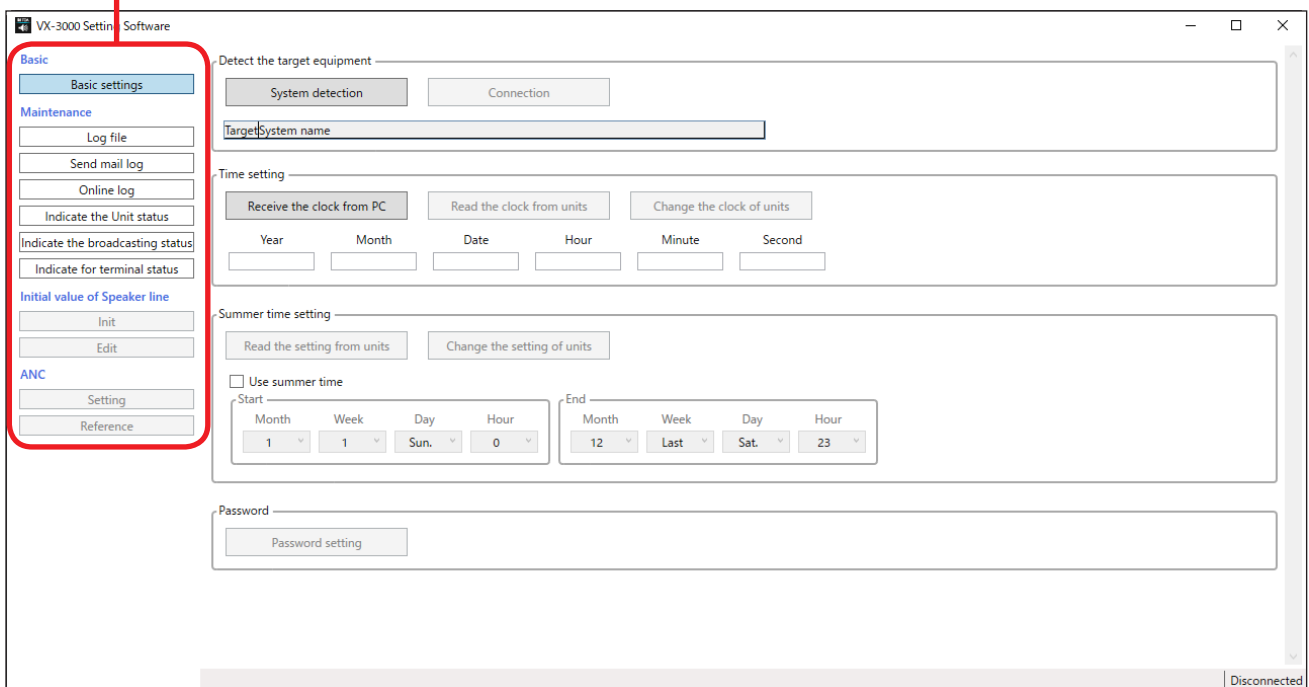

#### 20.1.1. Basic

Basic settings:

Detect the target equipment: Detects and establishes communication with the network-connected VX-3000F, then reads the log file, etc. from the VX-3000F.

Time setting: Confirms or sets the VX-3000F's internal clock.

Summer time setting: Sets this setting when using the summer time.

Password: Sets the password to access the VX-3000F.

#### 20.1.2. Maintenance

Log file: Displays the outputs log data. (See [p. 3-177](#).)

Send mail log: Displays the log data of the transmitted surveillance e-mails. (See [p. 3-181](#).)

Online log: Displays log data online. (See [p. 3-182](#).)

Indicate the Unit status: Displays system configuration or failure status online. (See [p. 3-185](#).)

Indicate the broadcasting status: Displays audio input and output status online. (See [p. 3-188](#).)

Indicate for terminal status: Displays control input and output status online. (See [p. 3-190](#).)

### 20.1.3. Initial value of Speaker line

Init: Initializes the Speaker line impedance value.

Edit: Edits the Speaker line impedance value.

### 20.1.4. ANC

Setting: Measure the reference value of the ANC sensor level.

Reference: Fine-adjust the reference value of the ANC sensor level.

## 20.2. Basic Settings

Clicking the Basic settings button displays the screen below.

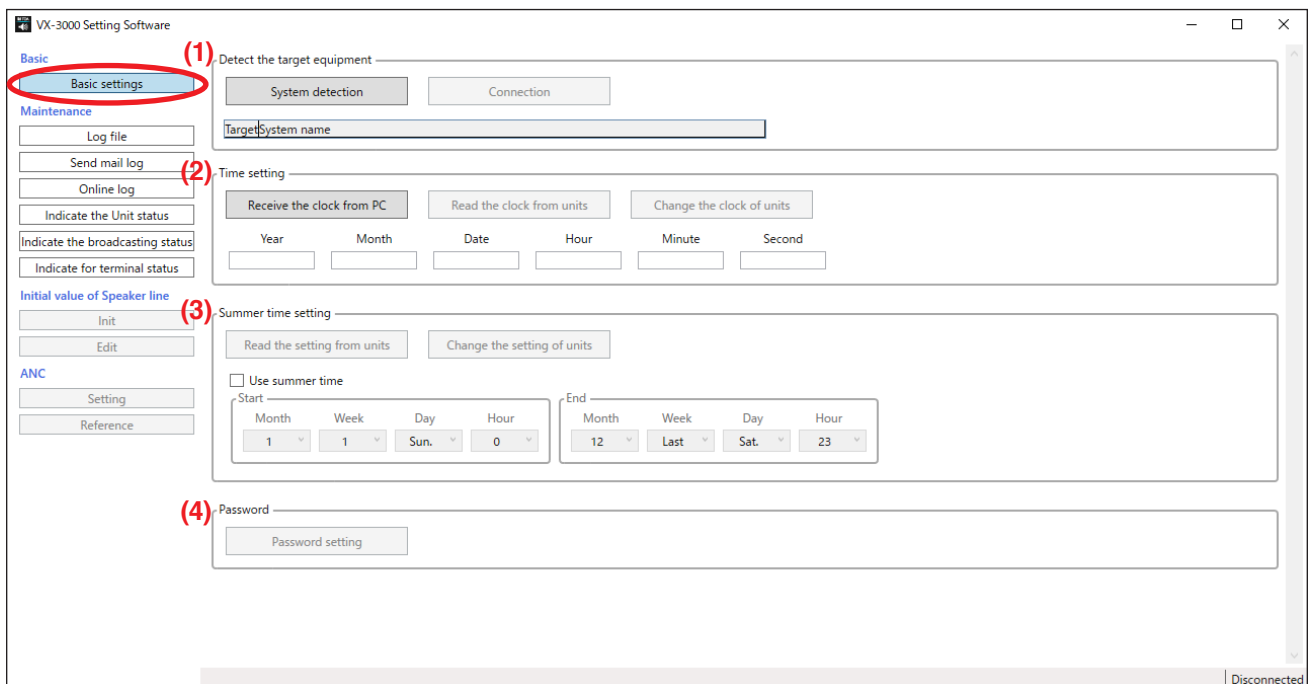

### (1) Detect the target equipment

- **System detection button**

Detects the VX-3000 systems connected to the local network and displays them in the Target system selection table. When the number of the detected systems is one, a connection is automatically established to that system.

- **Connection/Disconnect button**

The Disconnect button becomes valid after the establishment of a connection when a single VX-3000 system is detected.

The Connection button becomes valid when multiple VX-3000 systems are detected.

Select the target system by its name and establishes communications with it.

- **Target system selection table**

Detected VX-3000 system names are displayed.

When multiple VX-3000 systems are detected, select the system to which the whole maintenance function is made with a radio button in the target field.

### (2) Time setting

- **[Receive the clock from PC] button**

Reads the date and time from the PC's internal clock and displays them in the fields from "Year" to "Second" shown below the button.

- **[Read the clock from units] button**

Reads the date and time set to the VX-3000F (ID: 0) within the system and displays them in the fields from "Year" to "Second" shown below the button.

This button becomes valid when communication with the target system is established by the Connection button.

- **[Change the clock of units] button**

Set the date and time entered in the fields from "Year" to "Second" to the VX-3000F.

- **Year, Month, Day, Hour, Minute, Second Fields**

Display the date and time acquired using the [Receive the clock from PC] button or [Read the clock from units] button.

You can also enter the date and time you wish to set to the VX-3000F.

Entered date and time can be set to the VX-3000F using the [Change the clock of units] button.

Use the [Receive the clock from PC] button or [Read the clock from units] button to update the display contents.

Automatic update is not performed.

**Notes**

- Any field cannot be left blank nor can the irregular date and time be entered.
- Enter the "Year" field in the range of 2000 to 2099.

### (3) Summer time setting

- **[Read the setting from units] button**

Reads the summer time setting from the VX-3000F (ID: 0) unit.

- **[Change the setting of units] button**

Writes the summer time setting to the VX-3000F units.

- **[Use summer time] check box**

Set whether or not to enable summer time. Checking the checkbox allows to set start and end times.

- **Month, Week, Day, Hour fields**

Set the summer time start and end times and dates.

### (4) Password

- **Password setting button**

Used to set a password to the VX-3000F.

## 20.2.1. VX-3000 system detection and connection

Detect the VX-3000 systems connected to the local network and select one to connect to.

**Note**

The VX-3000 Setting software cannot be used to write settings information to units if their IP addresses are not correctly set using the TOA Finder.

**Step 1.** Click the System detection button.

The VX-3000 systems connected to the local network are detected and displayed in the Target system selection table.

When the number of the detected systems is one, a connection is automatically established to that system. In this case, proceed to **Step 4**.

When multiple VX-3000 systems are detected, proceed to **Step 2**.

When no system is detected, an error dialog appears. Check cable connections, then retry **Step 1**.

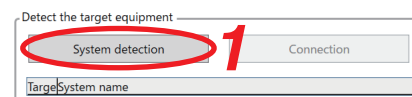

(Example when the number of the detected systems is one)

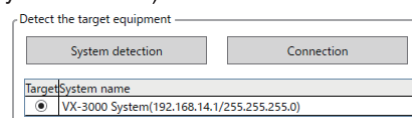

**Step 2.** When multiple VX-3000 systems are detected, select the VX-3000 system to connect to.  
Click the radio button in the "Target" field to select the VX-3000 system to connect to.

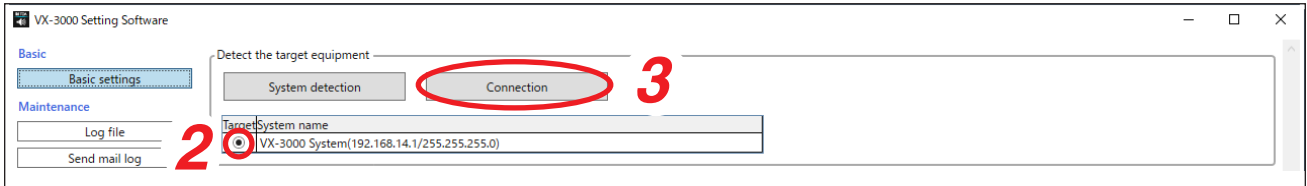

**Step 3.** Click the Connection button.  
A connection is established and the screen at right will appear.

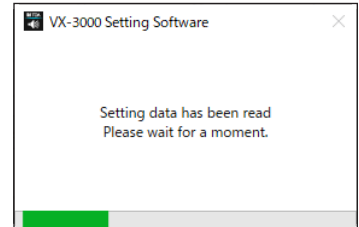

**Step 4.** Confirm the connection result.  
When the connection is correctly established, the button statuses will change as shown below.

The button becomes enabled.

The button changes to the Disconnect button.

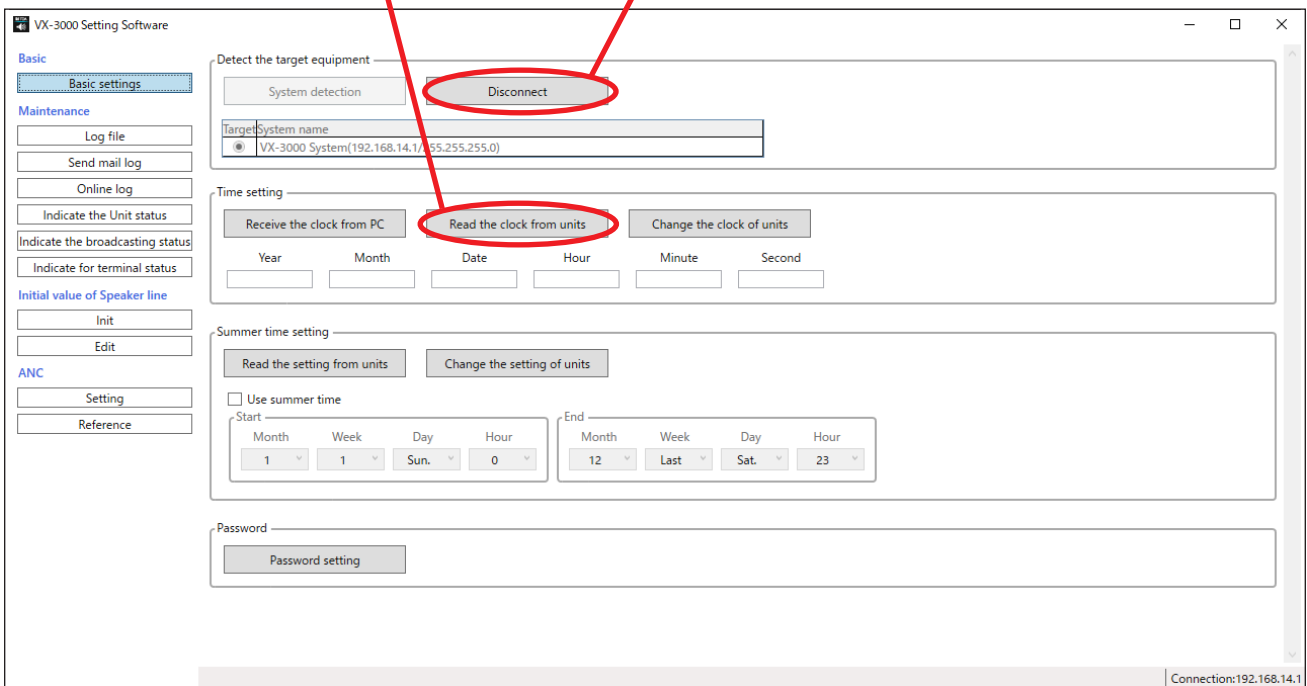

**Note**

When connection is not enabled, the screen at right will appear.  
In this case, close the screen by clicking the OK button, check cable connections, then retry from **Step 1**.

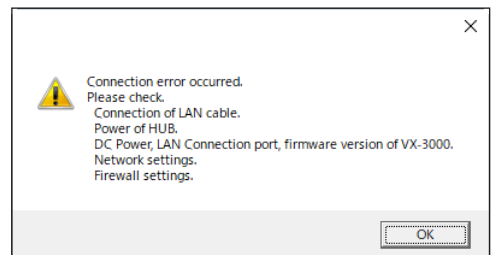

## 20.2.2. Time setting

[When reading the PC time and transmitting it to the VX-3000F]

- Step 1.** Click the [Receive the clock from PC] button.  
Time is read from the PC.

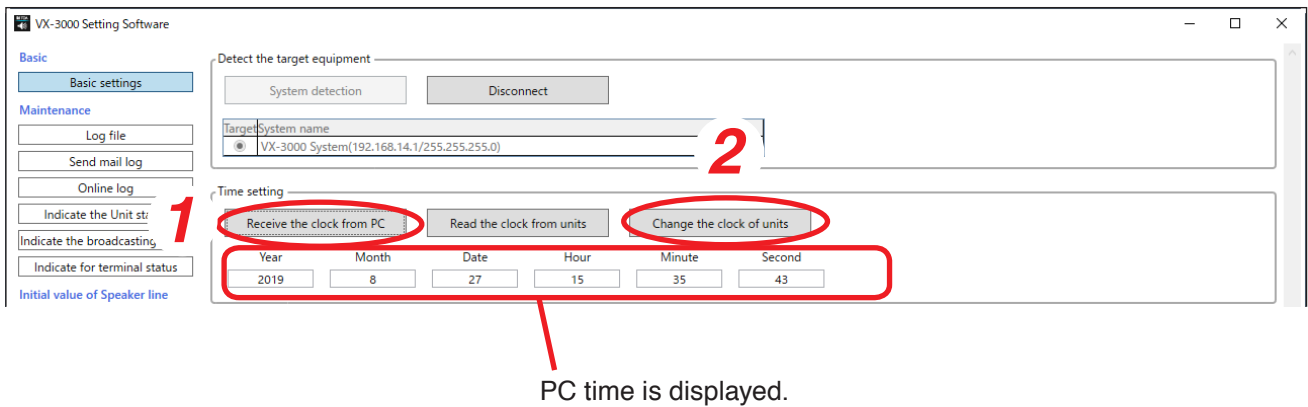

- Step 2.** Click the [Change the clock of units] button.  
The progress bar appears and the settings will be transmitted.

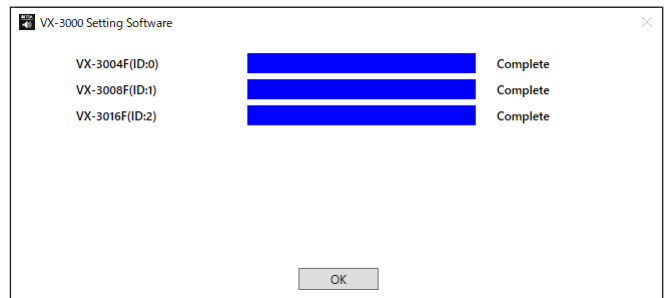

[When reading the time of the VX-3000F set to "ID: 0" and transmitting it to the VX-3000F]

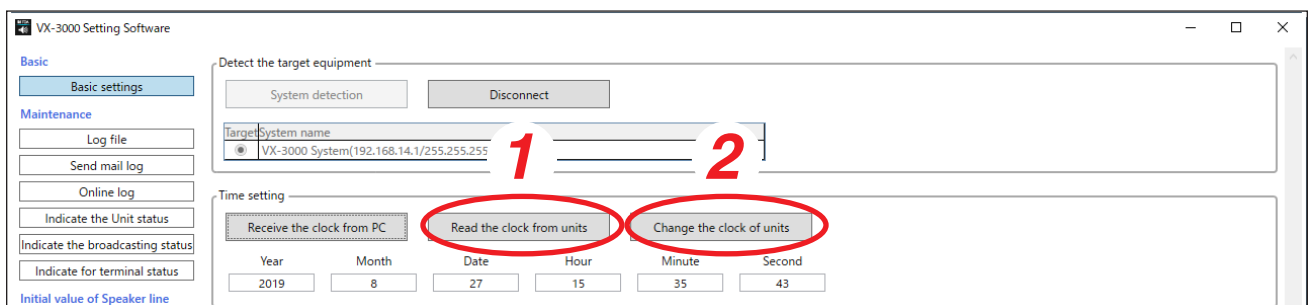

- Step 1.** Click the [Read the clock from units] button.  
Time from the VX-3000F set to "ID: 0" is read.
- Step 2.** Click the [Change the clock of units] button.  
The progress bar appears and the settings will be transmitted.

### 20.2.3. Summer time setting

When using the summer time, set Summer time setting as below.

**Step 1.** Check the checkbox for "Use summer time."

**Step 2.** Set the summer time start and end times and dates.

Specify the times and dates in the form of hour, n-th day of the week, month.

It is also possible to specify them in the form of the last day of the week, month.

(Setting example)

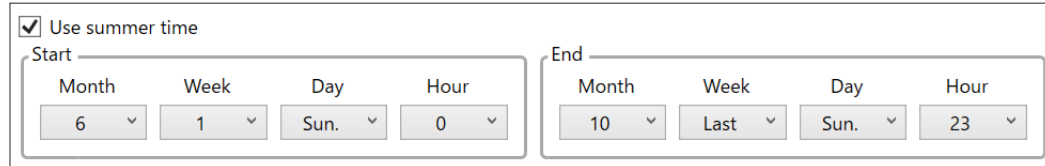

Use summer time

Start

Month	Week	Day	Hour
6	1	Sun.	0

End

Month	Week	Day	Hour
10	Last	Sun.	23

If setting is made as shown on the above screen, the start and end dates are set as shown below.

June

Sun	Mon	Tue	Wed	Thu	Fri	Sat
	1	2	3	4	5	6
Start of summer time →	7	8	9	10	11	12
	14	15	16	17	18	19
	21	22	23	24	25	26
	28	29	30			

October

Sun	Mon	Tue	Wed	Thu	Fri	Sat
				1	2	3
4	5	6	7	8	9	10
11	12	13	14	15	16	17
18	19	20	21	22	23	24
End of summer time →	25	26	27	28	29	30
						31

#### Note

VX-3000 system's summer time function is effective only when the time difference between the summer time and standard time is 1 hour.

The VX-3000F's clock may shift from the PC's time if the summer time set at a PC differs from that set at the VX-3000F in such case that the VX-3000F is used in the area where the time difference between the summer time and standard time is 30 minutes.

## 20.2.4. Password setting

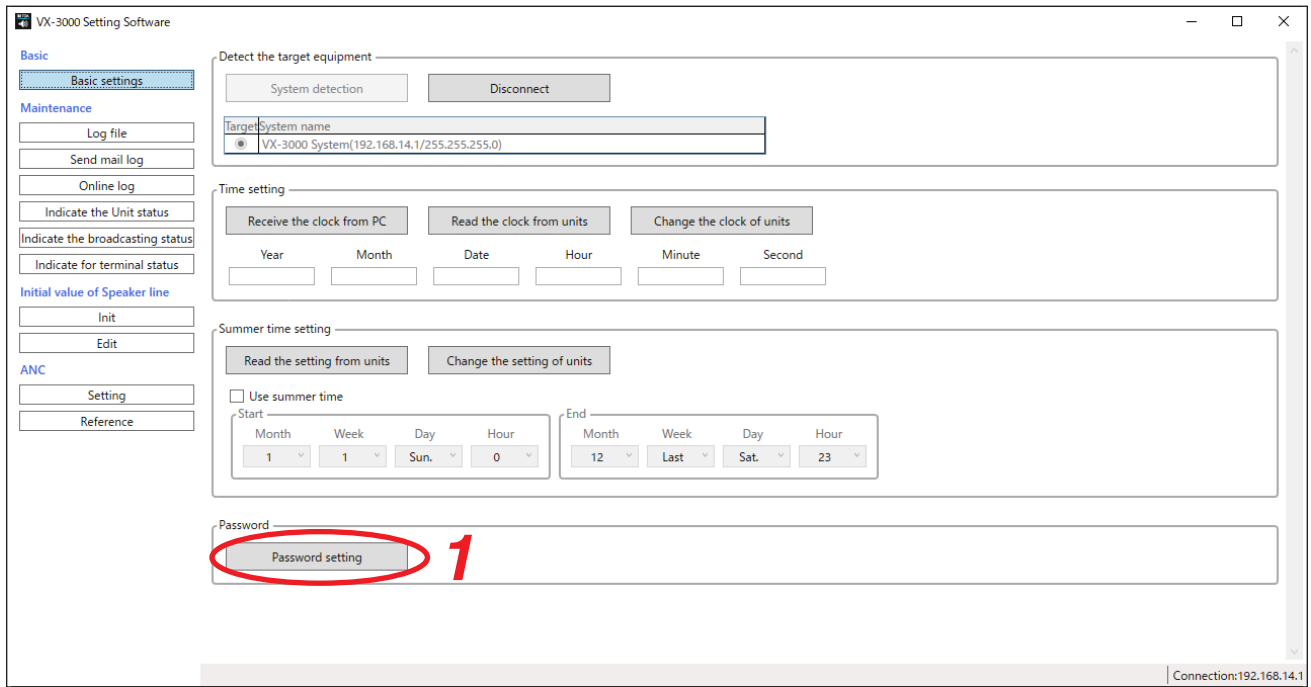

**Step 1.** Click the Password setting button.  
A password setting screen is displayed.

**Step 2.** Enter both the old password and new password, then click the OK button.

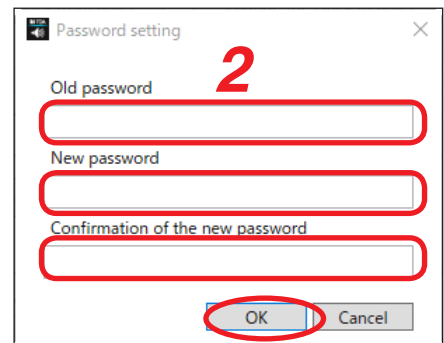

A confirmation dialog is displayed.

**Step 3.** Click the OK button.  
The new password will be transmitted to the VX-3000Fs.

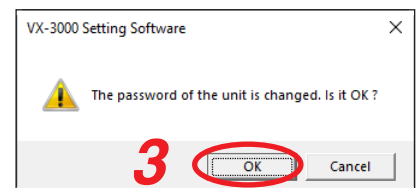

**Step 4.** Click the OK button after transmission is complete.

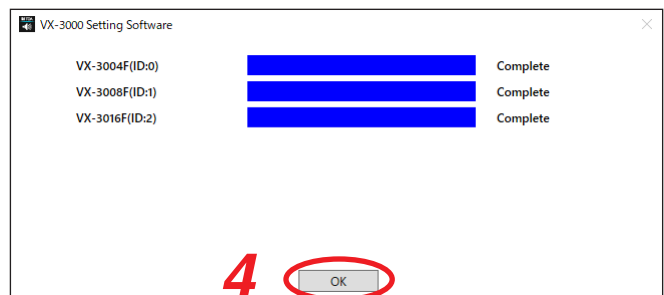

## 20.3. Log File

Clicking the Log file button displays the screen below.

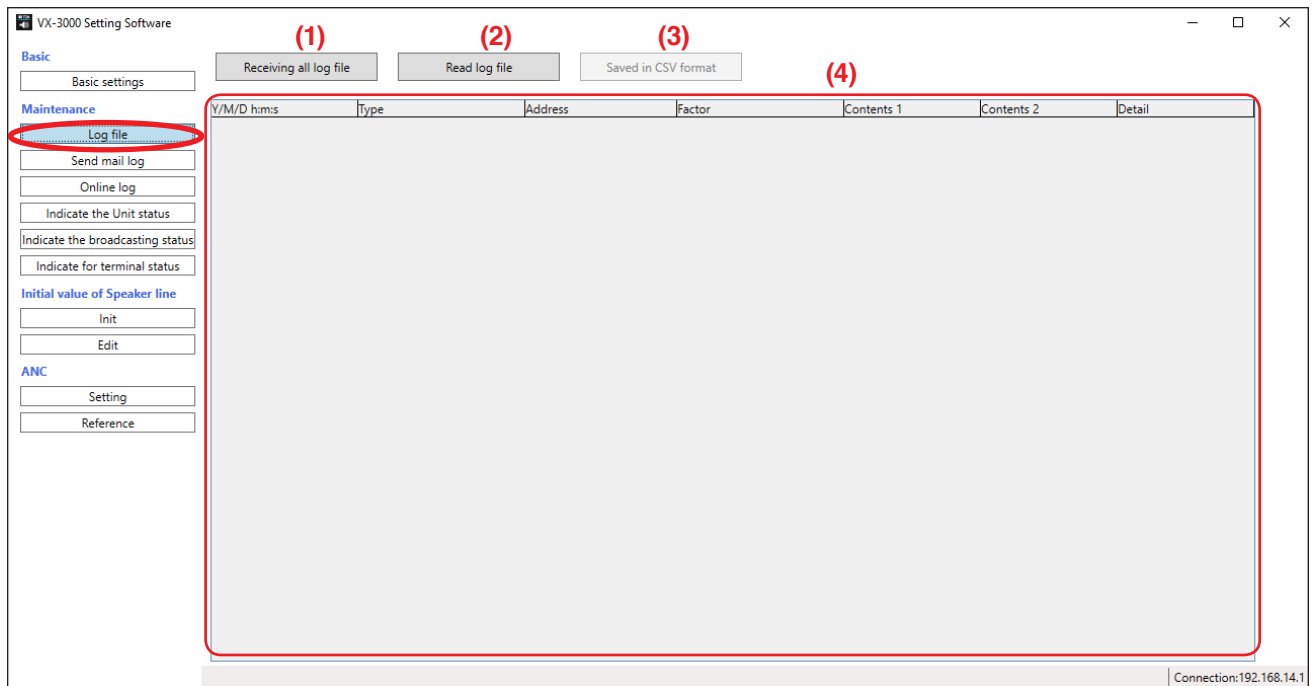

### (1) [Receiving all log file] button

Reads the Log data from the unit.

### (2) Read log file button

Reads the Log data from a file (file extension: .v3l).

### (3) [Saved in CSV format] button

Saves the Log data in a CSV file.

### (4) Log display

Displays the Log contents.

### 20.3.1. Receiving all log file

An entire log file can be read and saved from the VX-3000F (ID: 0) with the procedures below.

**Step 1.** Click the [Receiving all log file] button.

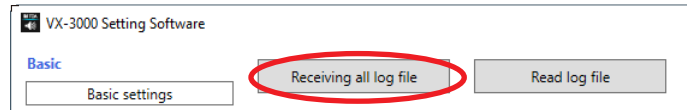

A "Browse For Folder" dialog is displayed.

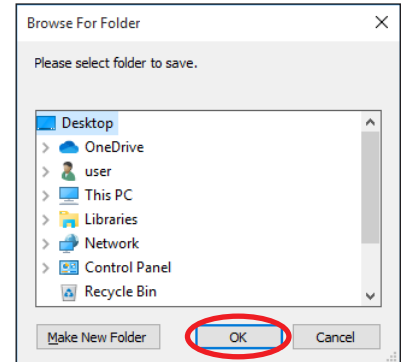

**3**

**Step 2.** Select the folder where the log file is to be saved.

**Step 3.** Click the OK button.  
A complete dialog is displayed.

**Step 4.** Click the OK button.  
The "Browse For Folder" dialog is closed after the log data has been saved.

### 20.3.2. Reading the log file

When log data is not displayed on the log file screen or when it is desirable to display other log data stored in a different folder from that in which the currently displayed log data is stored, read the log file (.v3l) in the following procedure.

**Step 1.** Click the Read log file button on the log file screen.

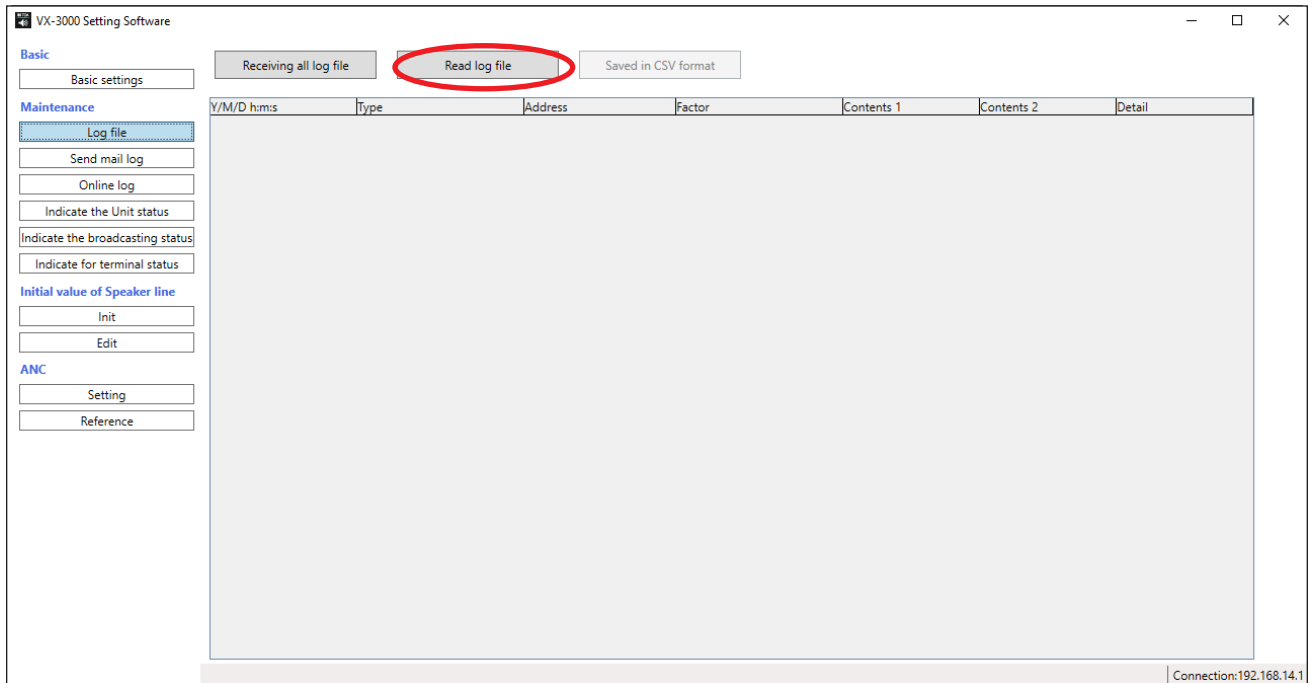

An "Open" dialog is displayed.

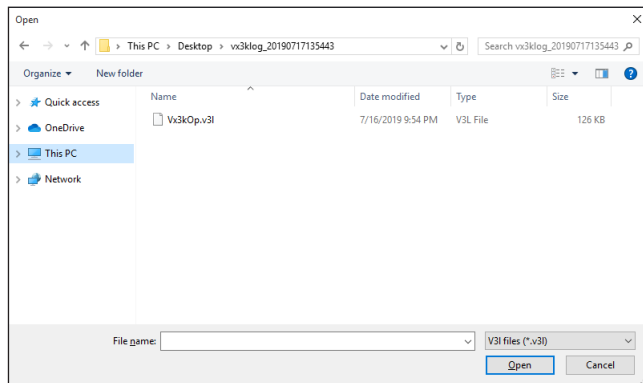

**Step 2.** Designate the folder where the log file is saved, and select the file, then click the Open button. Log data is displayed on the log display.

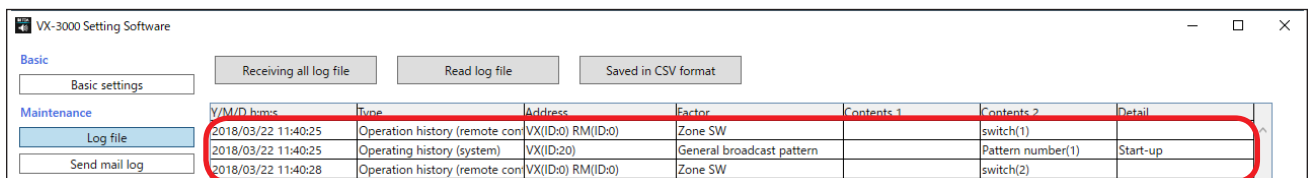

### 20.3.3. Saving the log file

Log data displayed on the log file display screen can be saved as a csv-format file in the following procedure.

**Step 1.** Click the [Saved in CSV format] button.

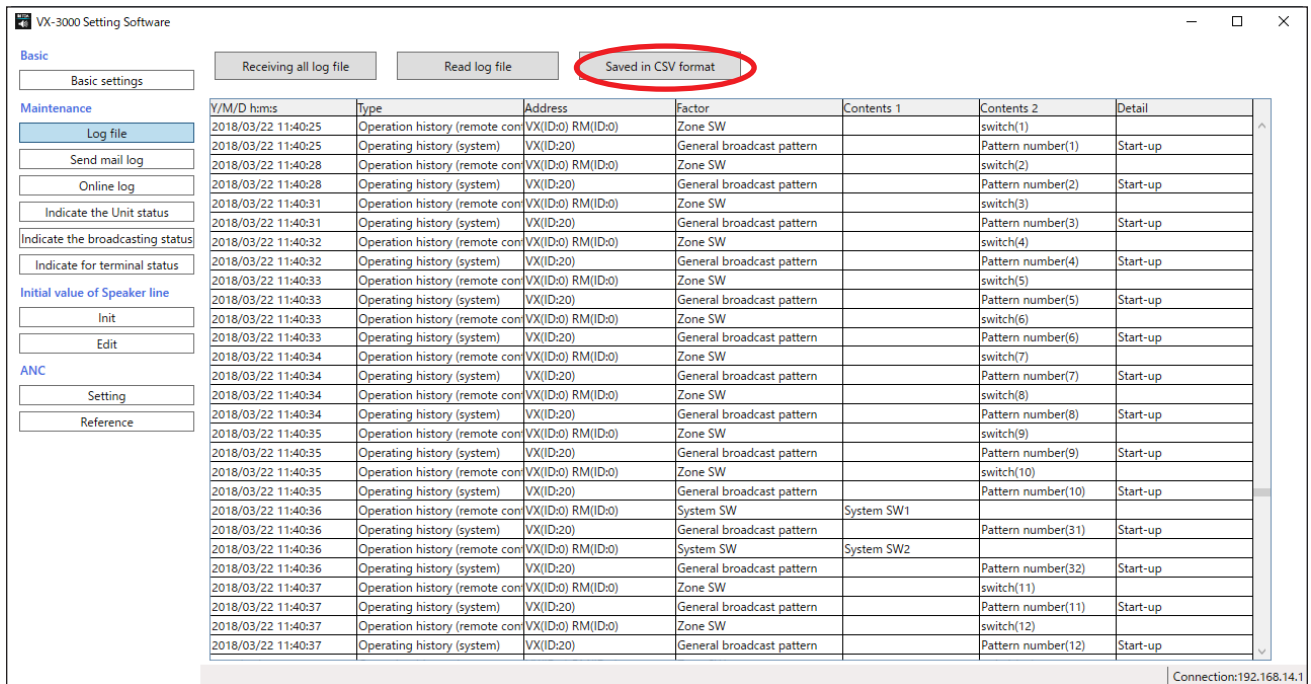

A "Save As" dialog is displayed.

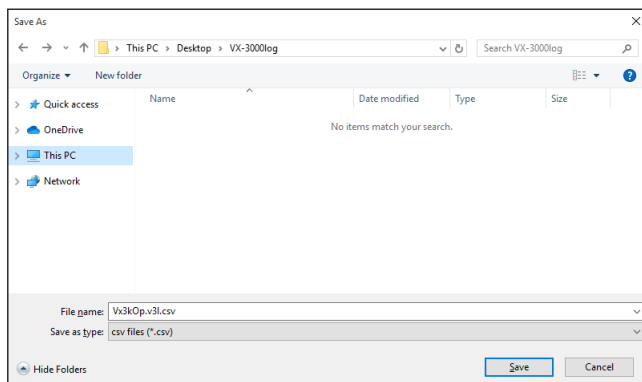

**Step 2.** Select the folder where the log file is to be saved.

**Step 3.** Set a "File name."

**Note**

The filename "(Read filename).csv" is set by default. When changing the filename, be sure to add a filename extension (csv).

Example: 0605 log file.csv

**Step 4.** Click the [Save] button.

The "Save as" dialog is closed after the log data has been saved.

## 20.4. Send Mail Log

Clicking the Send mail log button displays the screen below.

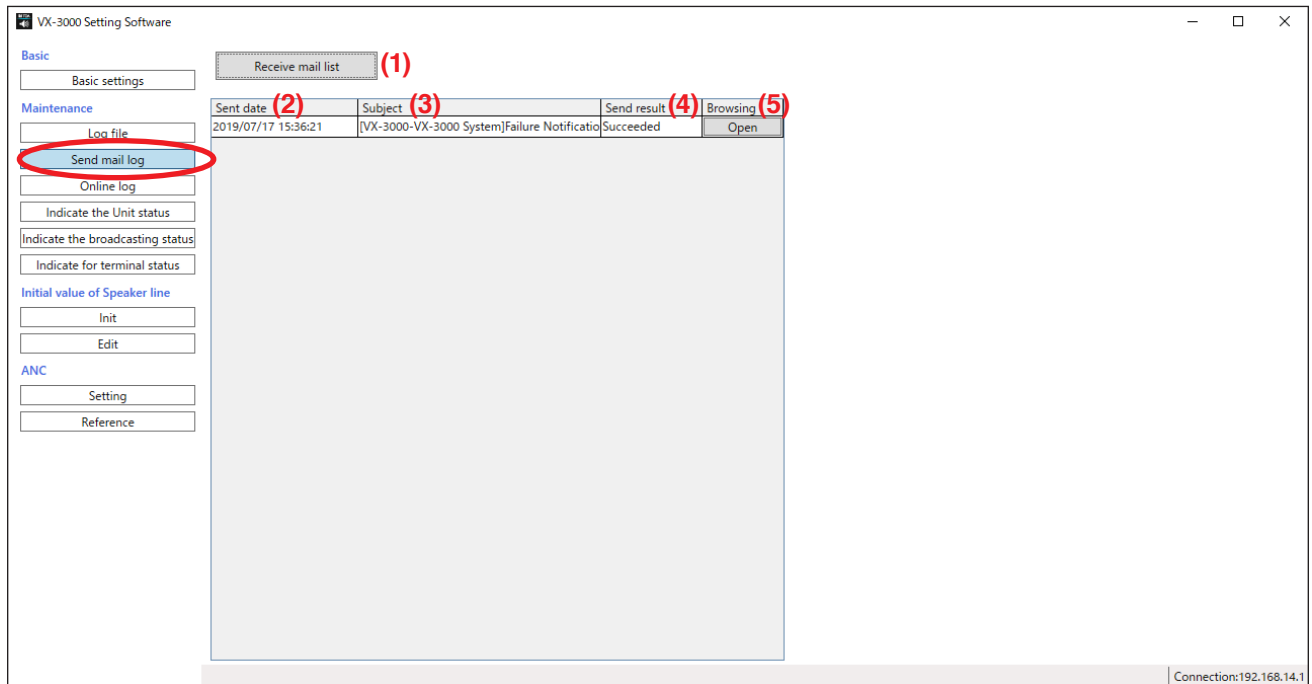

### (1) Receive mail list button

Receives the list of the Failure detection e-mails transmitted from the VX-3000F (ID: 0).  
Up to 100 e-mail histories are retained.

### (2) Sent date

Displays the transmission dates of the failure detection e-mails.

### (3) Subject

Displays the titles of the failure detection e-mails.

### (4) Send result

Displays the transmission results of the failure detection e-mails.

### (5) Browsing

You can view the contents of the transmitted failure detection e-mails.

## 20.5. Online Log

Clicking the Online log button displays the screen below.

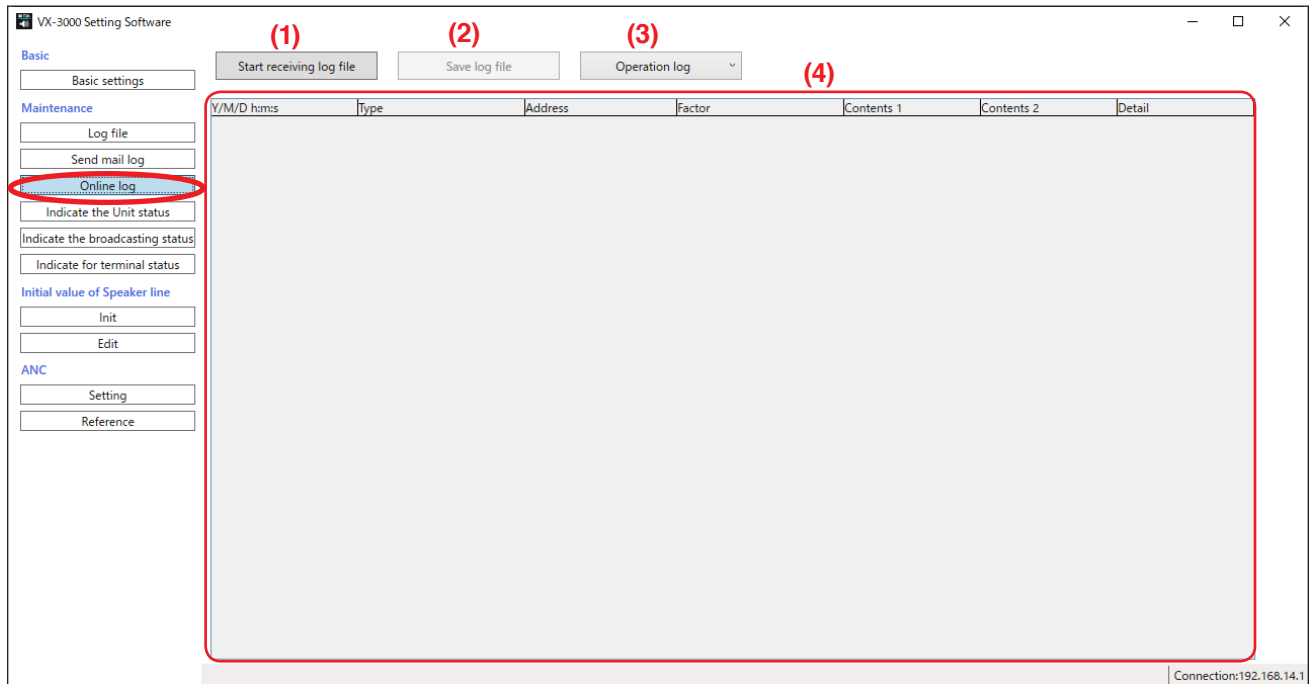

### (1) [Start receiving log file]/[Stop] button

Reads the Log data from the connected VX-3000F (ID: 0).

### (2) Save log file button

Saves the Log data into a file.

### (3) Log selection pull-down list

Select the type of Log to display from either the operation log or the error log.

### (4) Log display

Displays the Log contents.

### 20.5.1. Online log confirmation

The VX-3000F system operation and error logs can be confirmed in real time.

**Step 1.** Establish communications between the VX-3000F and the PC installed with the VX-3000F Setting software.

For the procedure for establishing communications, see [p. 3-172](#).

The "Connection" indication is displayed in the lower right corner of the screen after the connection is completed.

**Step 2.** Click the [Start receiving log file] button.

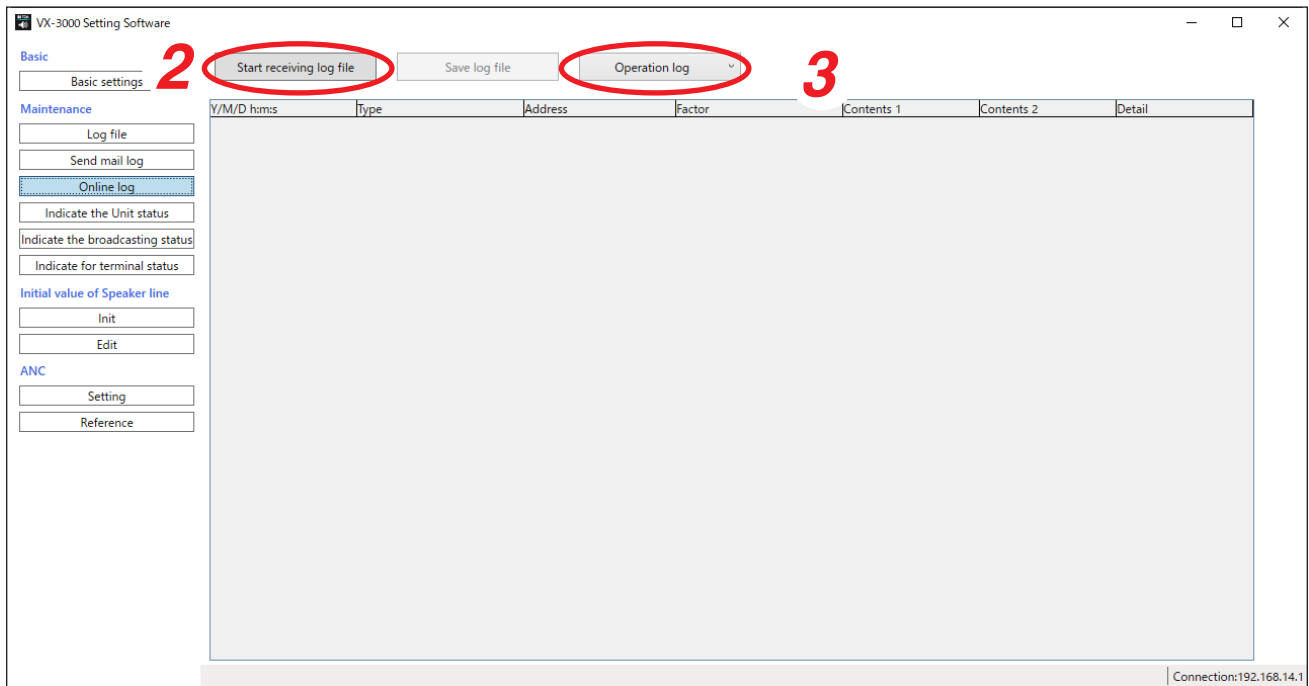

Logs are displayed in time sequence. The [Start receive log file] button changes to the [Stop] button. If a new operation or failure takes place, the logs are automatically updated and displayed.

#### Tip

To cause a log display update to pause, click the [Stop] button. The [Stop] button changes to the [Start receive log file] button. To display the log again, click the [Start receive log file] button.

**Step 3.** Select the type of Log to display.

Select the type from either the operation log or the error log using the Log selection pull-down list.

## 20.5.2. Saving log files acquired online

Log files displayed on the online log screen can be saved as a csv-format file in the following procedure.

**Step 1.** Click the [Save log file] button.

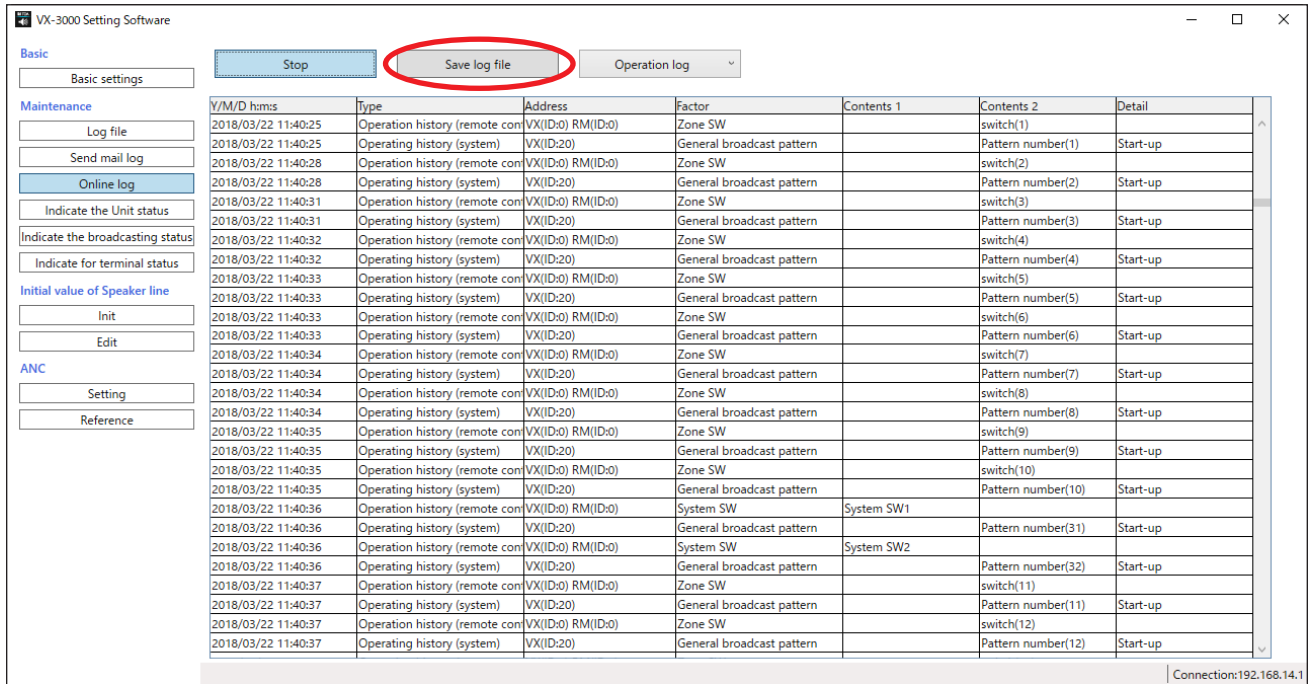

A "Browse For Folder" dialog is displayed.

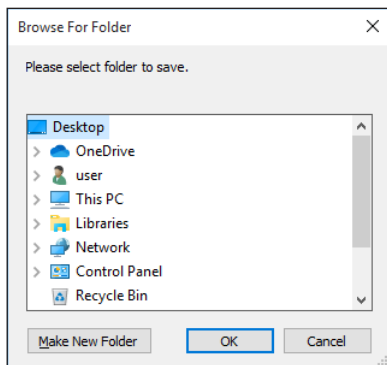

**Step 2.** Select the folder where the log file is to be saved.

**Step 3.** Click the OK button.

## 20.6. Indicate the Unit Status

Clicking the [Indicate the Unit status] button displays the "Indicate the Unit status" screen, allowing the following information to be confirmed in real time:

- Individual unit's setting and connection status
- Individual unit's operation mode and failure status
- Failure status of amplifiers, speaker lines and power supply

### 20.6.1. System status display confirmation

**Step 1.** Establish communications between the VX-3000F and the PC installed with the VX-3000 Setting software.

For the procedure for establishing communications, see [p. 3-172](#).

The "Connection" indication is displayed in the lower right corner of the screen after the connection is completed.

**Step 2.** Click the [Indicate the Unit status] button.

The "Indicate the Unit status" screen is displayed.

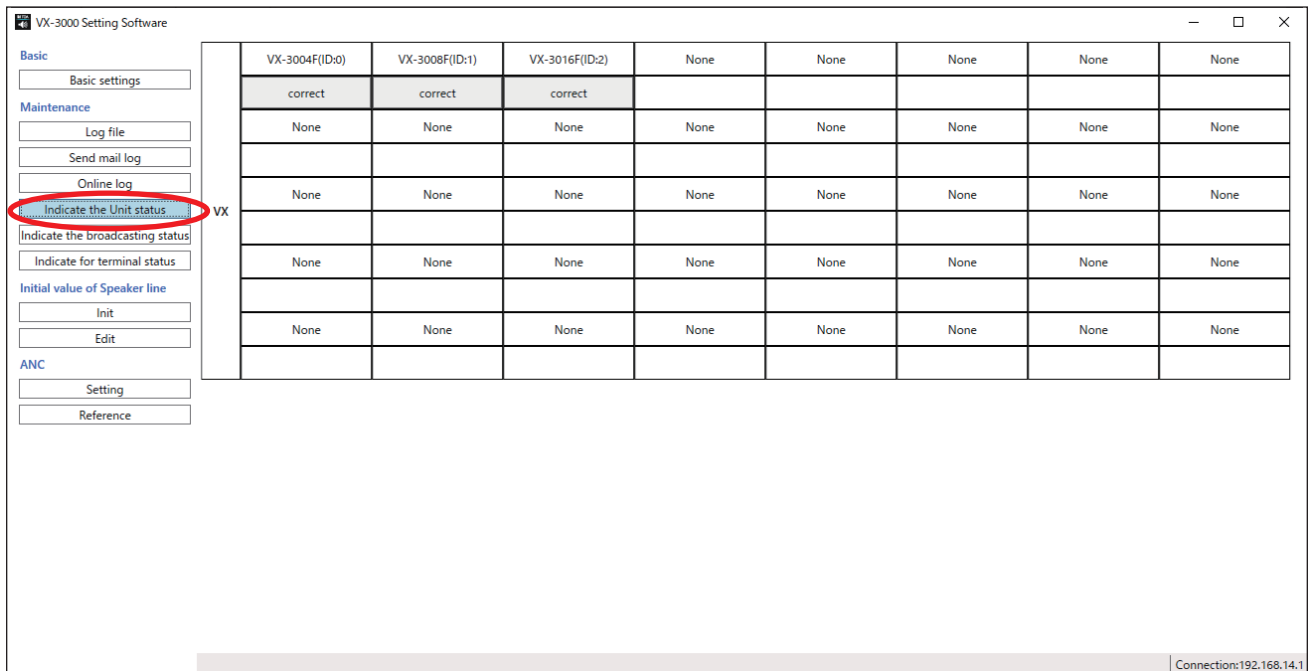

After information receipt is completed, the current system status is displayed on the "Indicate the Unit status" screen.

After the system status information has been acquired, the latest system status is automatically updated and displayed.

The screenshot displays the 'VX-3000 Setting Software' window. On the left, a sidebar contains several menu items: 'Basic' (Basic settings), 'Maintenance' (Log file, Send mail log, Online log, Indicate the Unit status, Indicate the broadcasting status, Indicate for terminal status), 'Initial value of Speaker line' (Init, Edit), and 'ANC' (Setting, Reference). The 'Indicate the Unit status' button is highlighted. The main area shows a table with columns for unit IDs and their status. The status for VX-3004F(ID:0) is 'correct', while VX-3008F(ID:1) and VX-3016F(ID:2) are 'error'. All other units are 'None'. A 'VX' label is positioned to the left of the table. The connection address 'Connection:192.168.14.1' is shown at the bottom right.

	VX-3004F(ID:0)	VX-3008F(ID:1)	VX-3016F(ID:2)	None	None	None	None	None
correct	error	error						
None	None	None	None	None	None	None	None	None
None	None	None	None	None	None	None	None	None
None	None	None	None	None	None	None	None	None
None	None	None	None	None	None	None	None	None
None	None	None	None	None	None	None	None	None
None	None	None	None	None	None	None	None	None
None	None	None	None	None	None	None	None	None

### 20.6.2. System status display explanation

Each unit's status is displayed on its corresponding button, and clicking on a button displays its detailed information screen. (Buttons for units that have not been set for connection cannot be selected.)

Two or more detailed information screens can be displayed (for the number of units set for connection).

The system status can be updated even when the detailed information screen is displayed.

Presence or absence of error is displayed on the button by each unit.

When some error occurs in the unit, the corresponding button becomes red.

### 20.6.3. Detailed display of each unit status

Clicking the VX-3000F button on the "Indicate the Unit status" screen displays the VX-3000F unit status screen.

**VX-3008F(ID:1)**

**Unit configuration**

Type	Configuration	Current	Status
VX-3008F	VX-3008F	VX-3008F	correct

**Rm configuration**

	Configuration	Current	Status
RM 0	RM-300X	RM-300X	correct
RM 1	None	None	correct
RM 2	None	None	correct
RM 3	None	None	correct
RM 4	None	None	correct
RM 5	None	None	correct
RM 6	None	None	correct
RM 7	None	None	correct

**Amp configuration**

	Configuration	Current	Status
AMP 1	500W	None	difference
AMP 2	None	None	correct
AMP 3	None	None	correct

**Unit failure status**

	Configuration	Status	Jump
Inside of the unit	Used	Normal	<a href="#">Detail</a>
Control input fault	Unused	-	<a href="#">Detail</a>
Extension input	Unused	-	<a href="#">Detail</a>
Standby Input	Unused	-	<a href="#">Detail</a>
DS	Unused	-	<a href="#">Detail</a>
SV AMP	Used	Normal	<a href="#">Detail</a>
SP	Unused	-	<a href="#">Detail</a>

**RM failure status**

	Configuration	Status	Jump
RM 0	Unused	-	<a href="#">Detail</a>
RM 1	Unused	-	<a href="#">Detail</a>
RM 2	Unused	-	<a href="#">Detail</a>
RM 3	Unused	-	<a href="#">Detail</a>
RM 4	Unused	-	<a href="#">Detail</a>
RM 5	Unused	-	<a href="#">Detail</a>
RM 6	Unused	-	<a href="#">Detail</a>
RM 7	Unused	-	<a href="#">Detail</a>

**AMP failure status**

	Configuration	Status	Jump
AMP 1	Unused	-	<a href="#">Detail</a>
AMP 2	Unused	-	<a href="#">Detail</a>
AMP 3	Unused	-	<a href="#">Detail</a>

Clicking the Detail button displays the detailed screen for each item as shown below.

**VX-3008F(ID:1) > Fault status > Inside of the unit**

	Configuration	Status	Jump
Connection fault	Used	Normal	
Unit fault	Used	Normal	
Model abnormality	Used	Normal	
Setting data abnormality	Used	Normal	
Sound source data abnormality	Used	Normal	
Analog link connector	Unused	-	
Unit power abnormality	Unused	-	
LAN connector A	Unused	-	
LAN connector B	Unused	-	

## 20.7. Indicate the Broadcasting Status

Clicking the [Indicate the broadcasting status] button displays the screen below.

The broadcast status of the VX-3000 system such as broadcast pattern being activated and audio signal input/output status can be confirmed online.

**Step 1.** Establish communications between the VX-3000F and the PC installed with the VX-3000 Setting software.

For the procedure for establishing communications, see [p. 3-172](#).

The "Connection" indication is displayed in the lower right corner of the screen after the connection is completed.

**Step 2.** Click the [Indicate the broadcasting status] button.

The "Indicate the broadcasting status" screen is displayed.

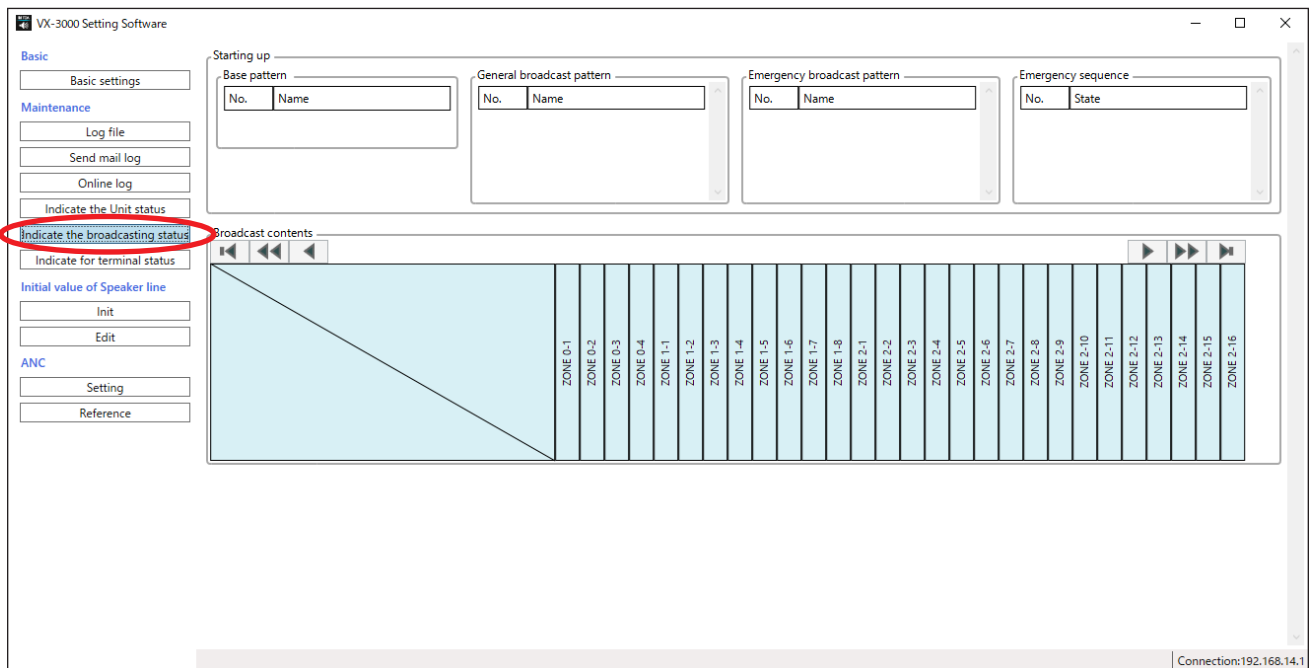

Broadcasting status data are automatically acquired.

After the data have been received, the current status is displayed on the "Indicate the broadcasting status" screen.

After the broadcast status data have been received, the latest system status is automatically updated and displayed.

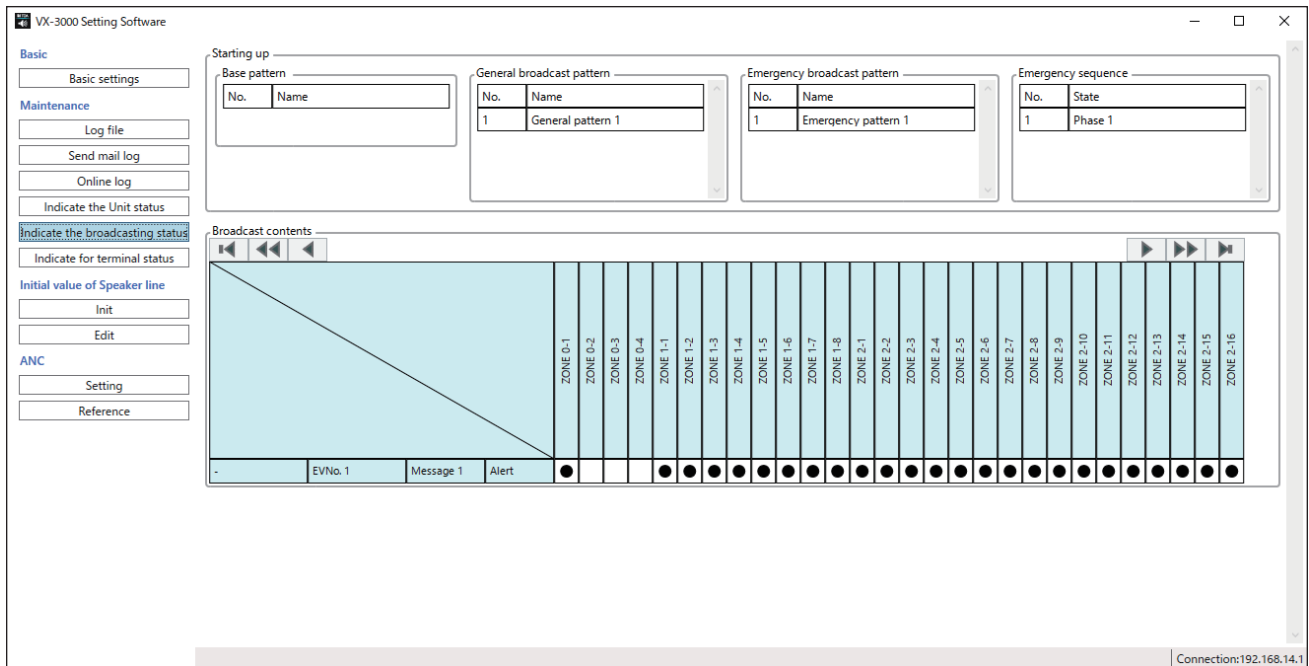

### [Broadcasting status display explanation]

#### (1) Starting up

- **Base pattern, General broadcast pattern, Emergency broadcast pattern**  
Each pattern being activated by way of the control input or with the Remote microphone's function key is displayed.
- **Emergency sequence**  
Emergency sequence being executed by the currently activated Emergency broadcast pattern is displayed.

#### (2) Broadcast contents

Displays which sound source is broadcast to which zone by which activation pattern. The output status and type of the sound source being broadcast can be confirmed.

## 20.8. Indicate for Terminal Status

The VX-3000 system control input and output statuses can be confirmed in real time.

**Step 1.** Establish communications between the VX-3000F and the PC installed with the VX-3000 Setting software.

For the procedure for establishing communications, see [p. 3-172](#).

The "Connection" indication is displayed in the lower right corner of the screen after the connection is completed.

**Step 2.** Click the [Indicate for terminal status] button.

The "Indicate for terminal status" screen is displayed.

The screenshot shows the VX-3000 Setting Software interface. The sidebar on the left contains several menu items under different categories: Basic (Basic settings), Maintenance (Log file, Send mail log, Online log, Indicate the Unit status, **Indicate for terminal status** (circled in red), Initial value of speaker line, Init, Edit), and ANC (Setting, Reference). The main area displays a table with the following structure:

Equipment	I/O	1	2	3	4	5	6	7	8	9	10	11	12	13	14	15	16	17	18	19	20	21	22	23	24
VX-3004F(ID:0)	Control input																								
	Emergency control input																								
	Control output																								
VX-3008F(ID:1)	Control input																								
	Emergency control input																								
	Control output																								
VX-3016F(ID:2)	Control input																								
	Emergency control input																								
	Control output																								

The status bar at the bottom right indicates "Connection:192.168.14.1".

Control input and output status data are automatically acquired.

After the data have been received, the current status is displayed on the "Indicate for terminal status" screen.

After the control input/output status data have been received, the latest system status is automatically updated and displayed.

Equipment	I/O	1	2	3	4	5	6	7	8	9	10	11	12	13	14	15	16	17	18	19	20	21	22	23	24
VX-3004F(ID:0)	Control input																								
	Emergency control input																								
	Control output		●																						
VX-3008F(ID:1)	Control input																								
	Emergency control input																								
	Control output																								
VX-3016F(ID:2)	Control input																								
	Emergency control input																								
	Control output																								

**[Control input/output status display explanation]**

The contact currently in active status is displayed with ● mark.

## 20.9. Initializing the Speaker Line Impedance

Set the initial value of the speaker line impedance in order to detect the speaker line open or short circuit. Only when using the speaker line surveillance, perform the impedance setting.

### 20.9.1. Displaying the "Init" screen

**Step 1.** Establish communications between the VX-3000F and the PC installed with the VX-3000 Setting software.

For the procedure for establishing communications, see [p. 3-172](#).

The "Connection" indication is displayed in the lower right corner of the screen after the connection is completed.

**Step 2.** Click the [Init] button.

The "Init" screen is displayed.

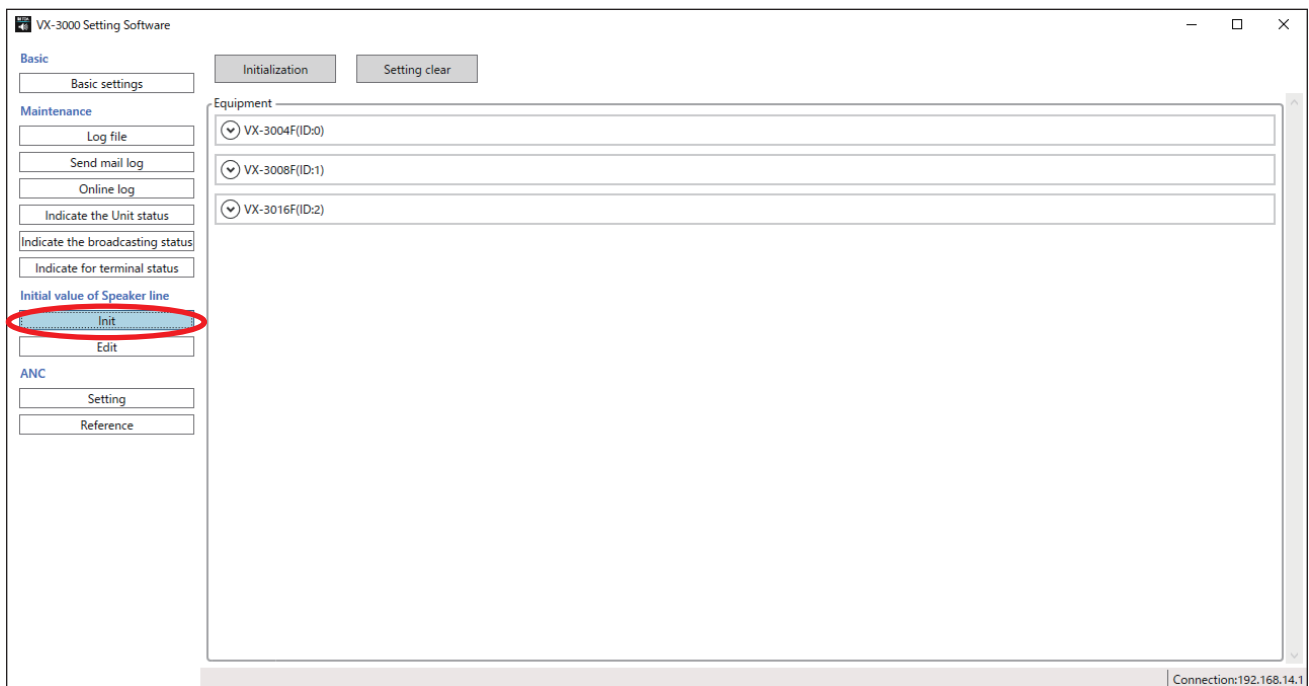

### ["Init" screen explanation]

#### (1) Begin Initialization button

Starts measuring the speaker line impedance of the zone selected in the equipment box and sets the measured value as the initial value.

#### (2) Setting clear button

Clears the speaker line impedance of the zone selected in the equipment box.

#### (3) Equipment

Used to select the zones to measure or clear the impedance.

## 20.9.2. Acquiring the initial impedance value

The initial impedance value is set by measuring the speaker line impedance of the specified zone.

### Note

When measuring the speaker line impedance, be sure to stop the broadcast in advance. Measuring cannot be made correctly when audio signals are being output.

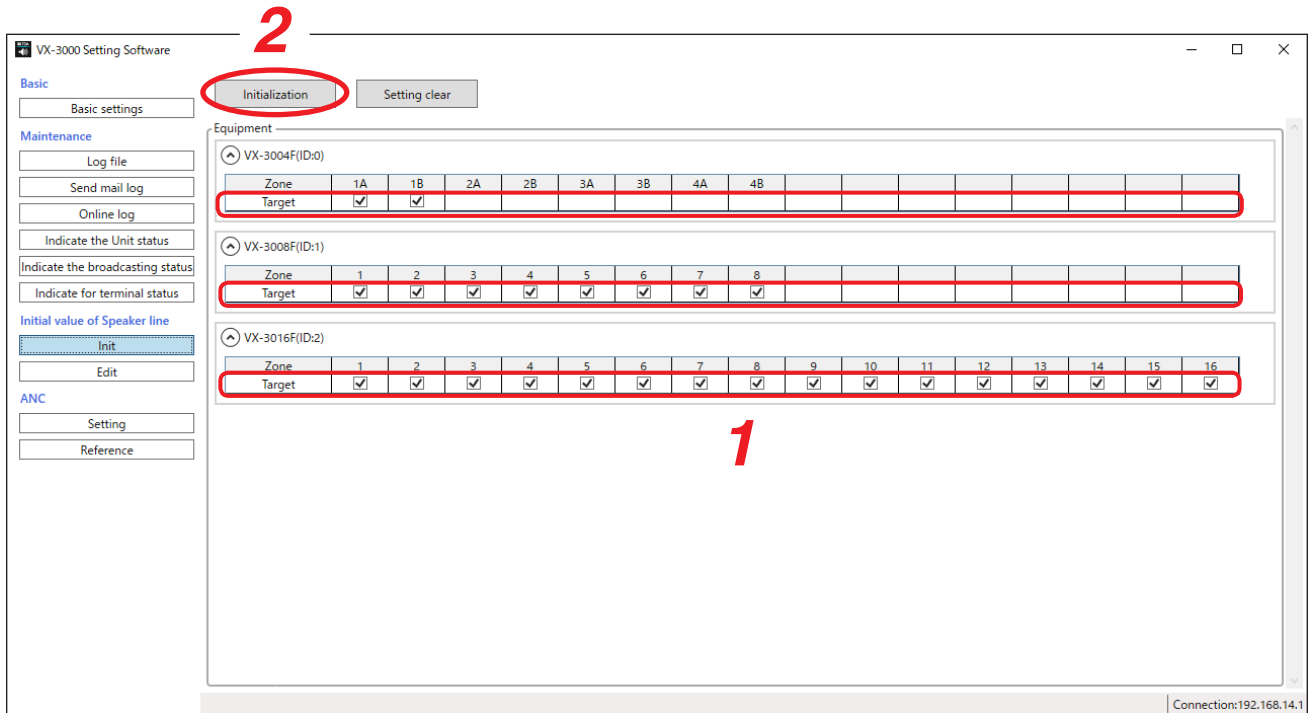

**Step 1.** Check the zone of which initial impedance value you wish to acquire in the equipment box.

### Tip

Clicking the "Target" cell allows all zones to be selected on the corresponding line.

**Step 2.** Click the Initialization button.

A confirmation dialog is displayed.

**Step 3.** Click the OK button.

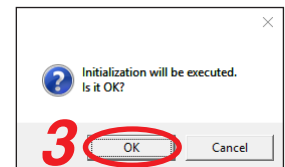

Measurement starts.

**Step 4.** Click the OK button after measurement completion.

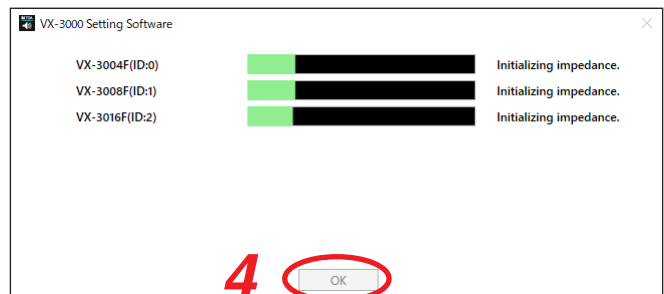

### 20.9.3. Clearing the impedance value

The measured impedance value of the specified zone can be cleared.

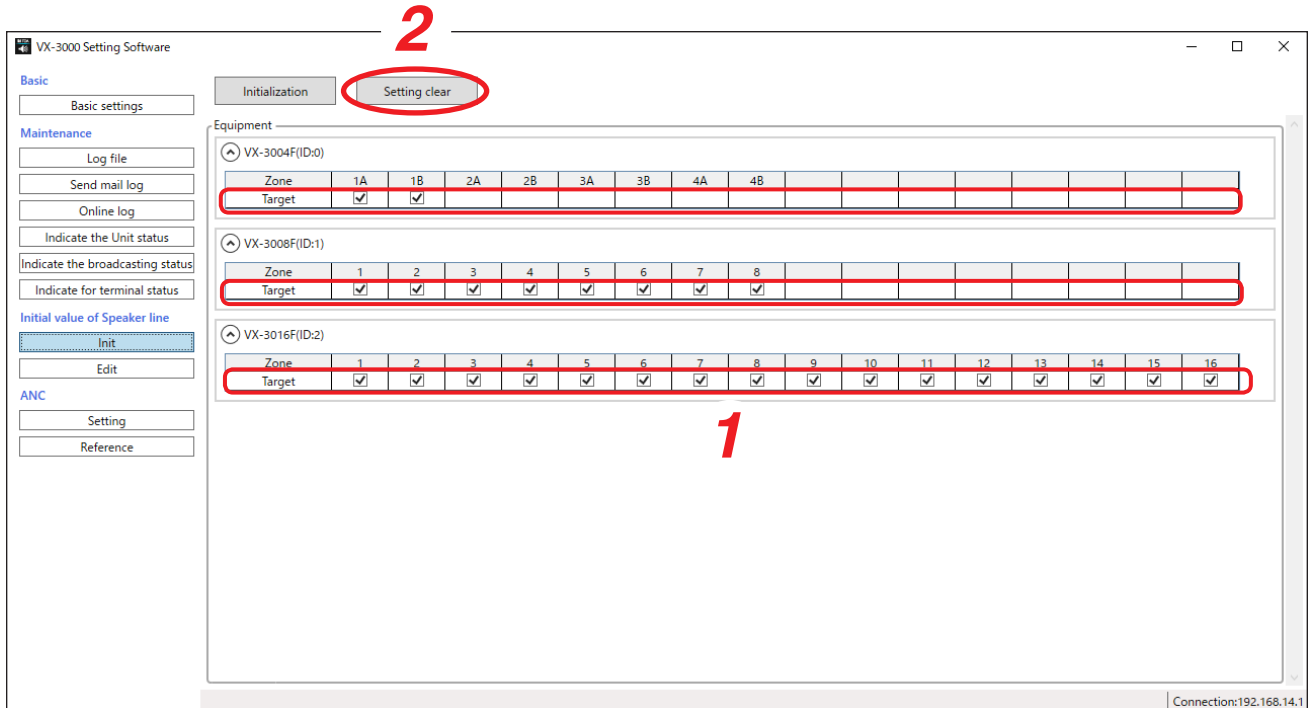

**Step 1.** Check the zone of which measured impedance value you wish to clear in the equipment box.

**Tip**

Clicking the "Target" cell allows all zones to be selected on the corresponding line.

**Step 2.** Click the Setting clear button.

A confirmation dialog is displayed.

**Step 3.** Click the OK button.

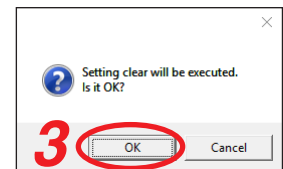

Clear starts.

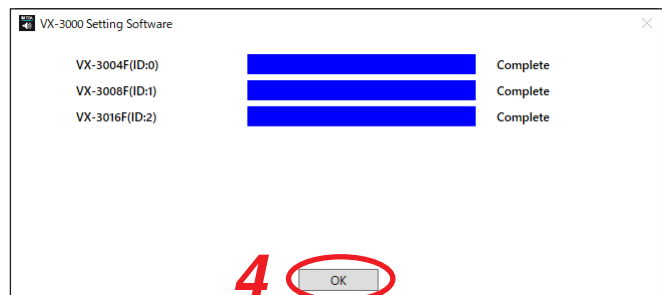

**Step 4.** Click the OK button after clear is complete.

## 20.10. Editing the speaker line impedance, etc.

Edit the initial value of the speaker line impedance and the impedance threshold value, both used for failure detection of speaker line open or short circuit.

### 20.10.1. Displaying the "Edit" screen

**Step 1.** Establish communications between the VX-3000F and the PC installed with the VX-3000 Setting software.

For the procedure for establishing communications, see [p. 3-172](#).

The "Connection" indication is displayed in the lower right corner of the screen after the connection is completed.

**Step 2.** Click the Edit button.

The "Edit" screen is displayed.

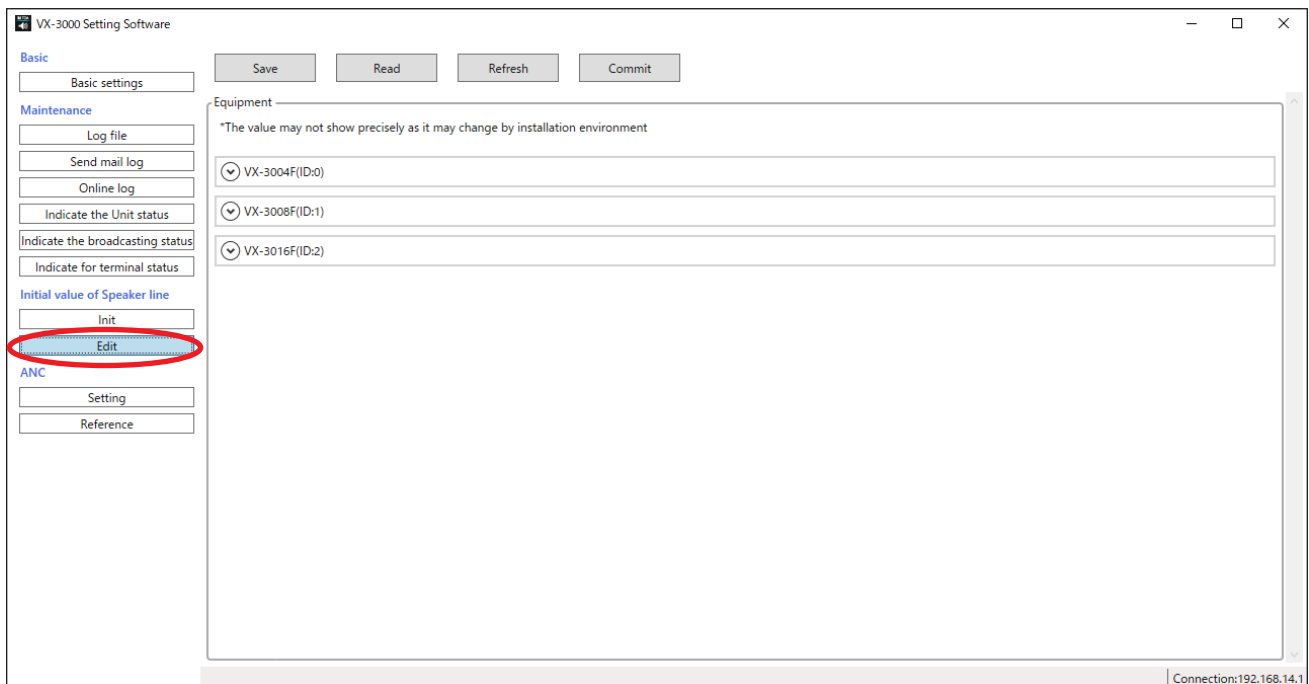

### ["Edit" screen explanation]

#### (1) Save button

Saves the edited data into a PC.

#### (2) Read button

Reads the impedance data saved in a PC.

#### (3) Refresh button

Reads the impedance setting from the VX-3000F.

#### (4) Commit button

Sets the PC-set contents into the VX-3000F.

#### (5) Equipment

Each zone status can be displayed.

Initial impedance value and other settings can be displayed and edited.

##### • Status

Indicate the zone status.

---: Unused

NORMAL: In normal operation

OPEN: Speaker line open

SHORT: Speaker line short-circuited

- **Initial value**

Indicates the initial impedance value.

**Note**

The value displayed after executing the impedance initialization is an approximate total value of the speaker impedance and the line impedance.

If you need the precise impedance value, measure it using an impedance meter separately.

- **Open range (%)**

Indicates the threshold value to judge the speaker line open.

Available Settings	101 to 800 (%)
--------------------	----------------

- **Short range (%)**

Indicates the threshold value to judge the speaker line short-circuited.

Available Settings	5 to 50 (%)
--------------------	-------------

### 20.10.2. When reading the impedance setting from the unit

Step 1. Click the Refresh button.

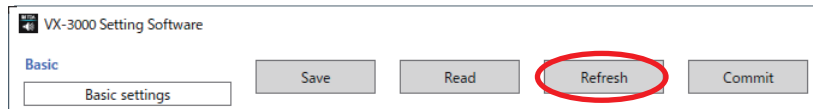

A dialog of receiving impedance is displayed.

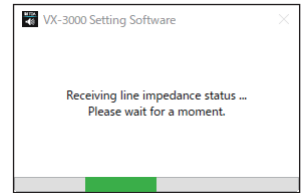

When reading is complete, the values of "Status," "Initial value," "Open range," and "Short range" will be displayed.

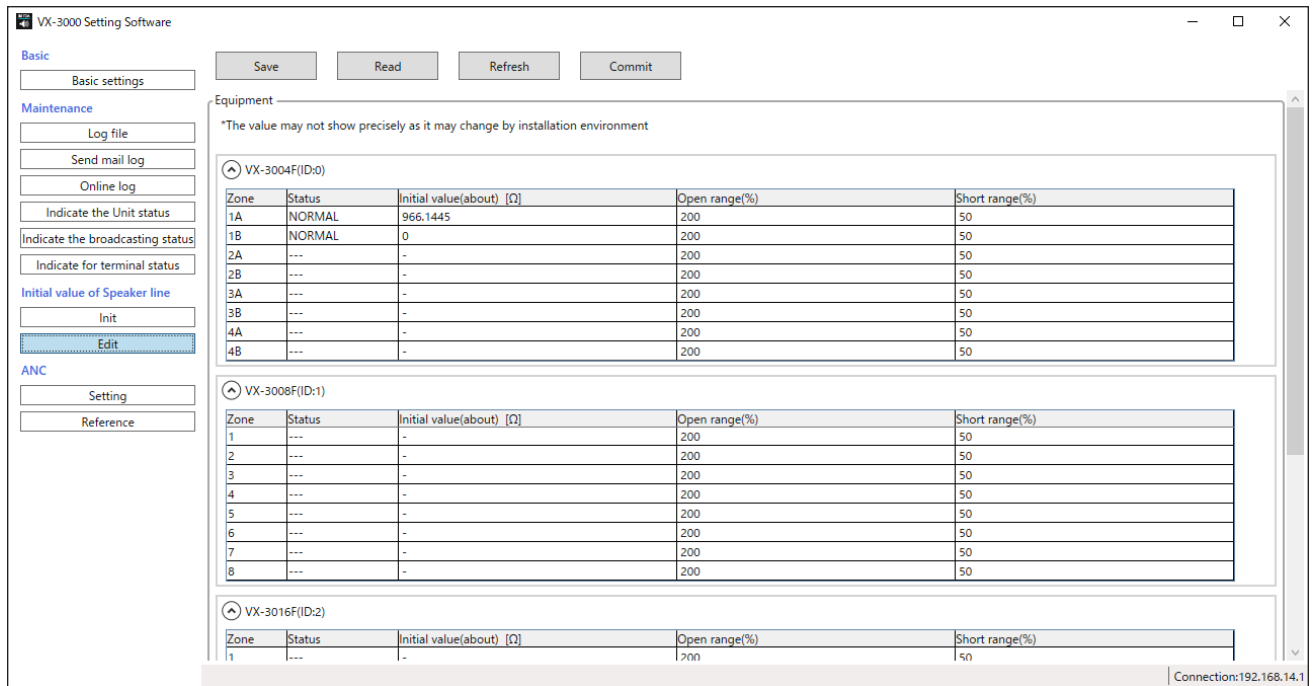

### 20.10.3. When reading the impedance setting saved in a PC

**Step 1.** Click the Read button.

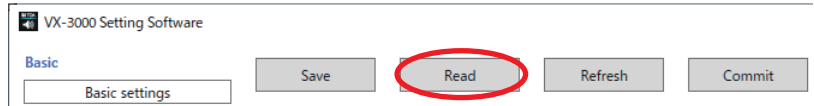

"Open" dialog is displayed.

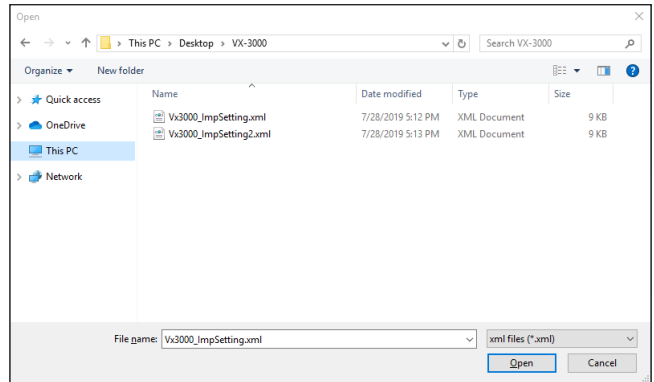

**Step 2.** Select the saved impedance setting file, then click the Open button.

The values of "Status," "Initial value," "Open range," and "Short range" read from the file are displayed.

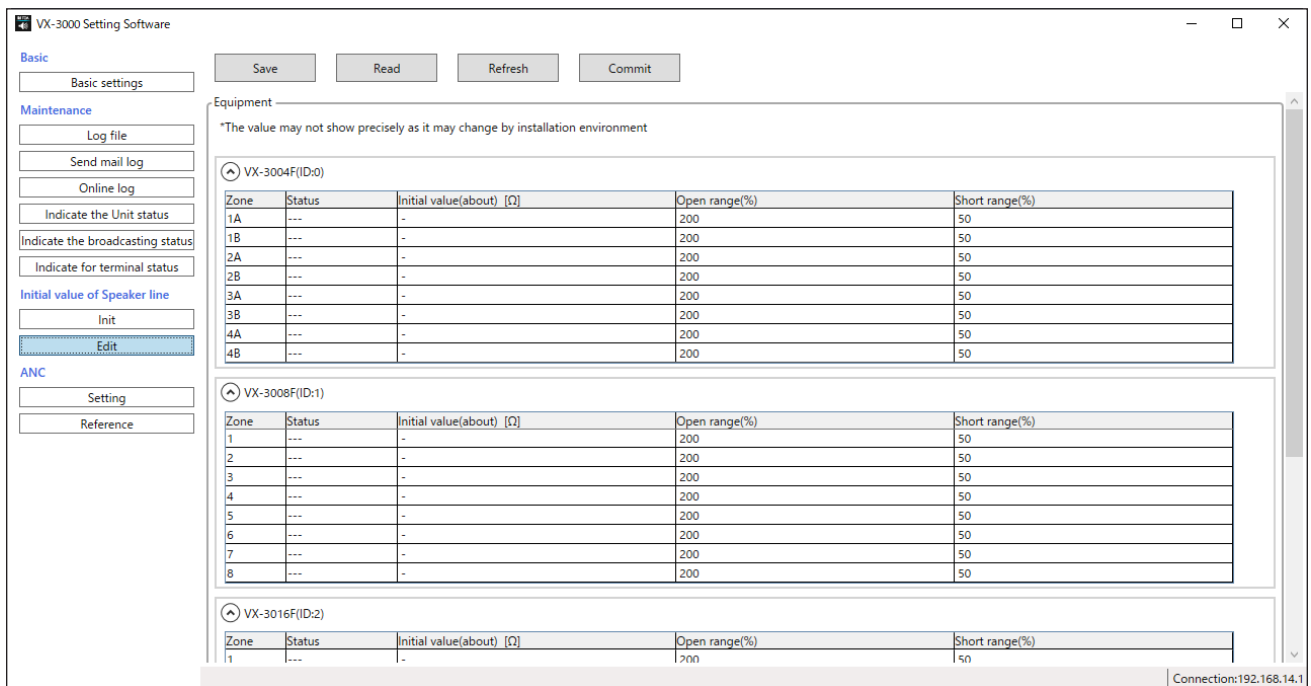

### 20.10.4. When editing the impedance setting

"Initial value," "Open range," and "Short range" items can be edited.

**Step 1.** Double-click the cell that indicates the value you wish to edit.  
The cell becomes editable.

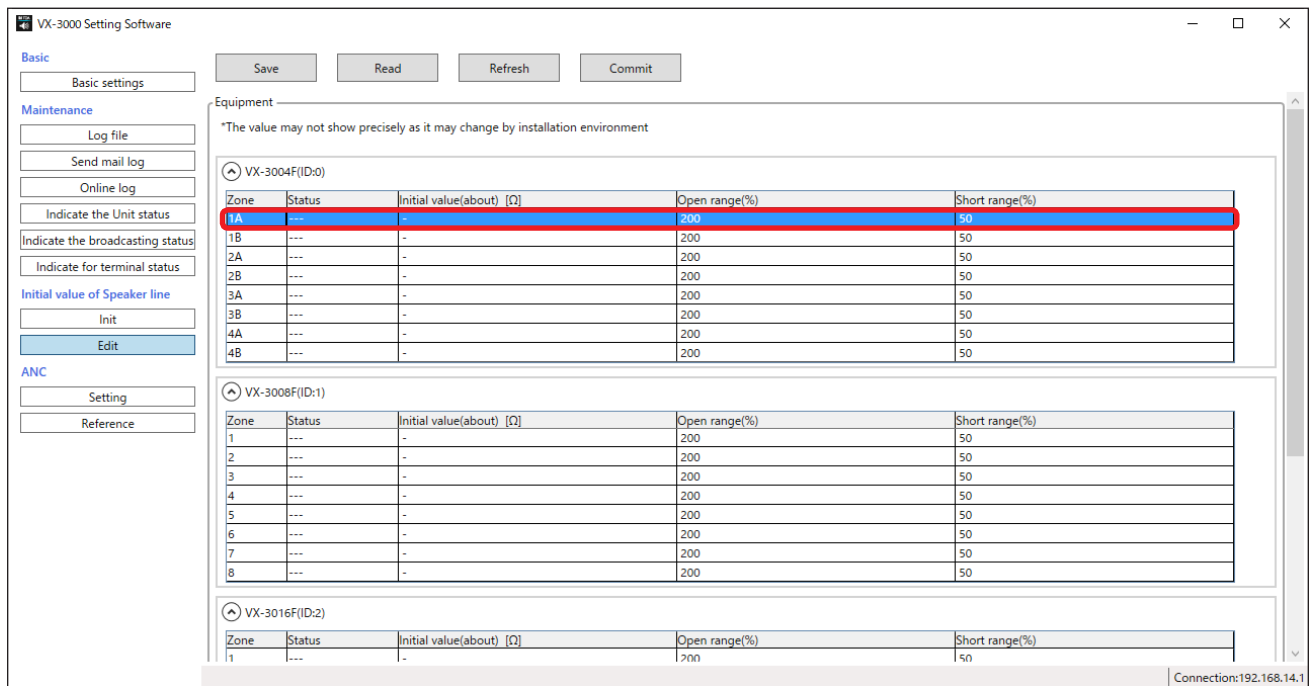

**Step 2.** Enter a numeric value from the keyboard.

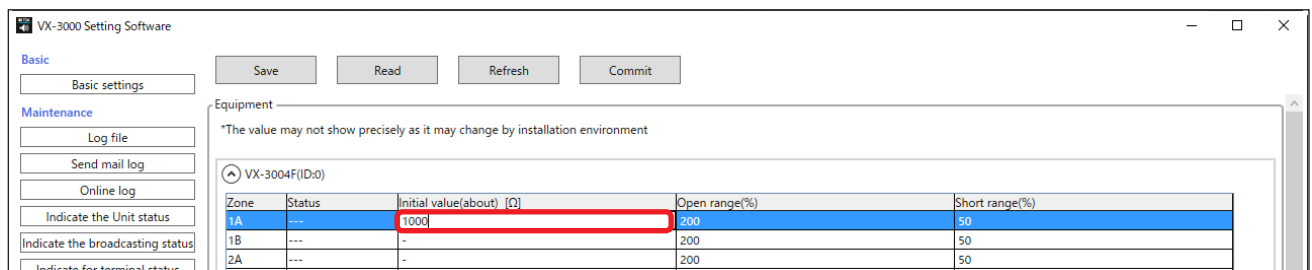

**Step 3.** Repeat **Steps 1** and **2** as many times as needed.

### 20.10.5. When saving the edited impedance setting

"Initial value," "Open range," and "Short range" items can be saved.

**Step 1.** Click the Save button.

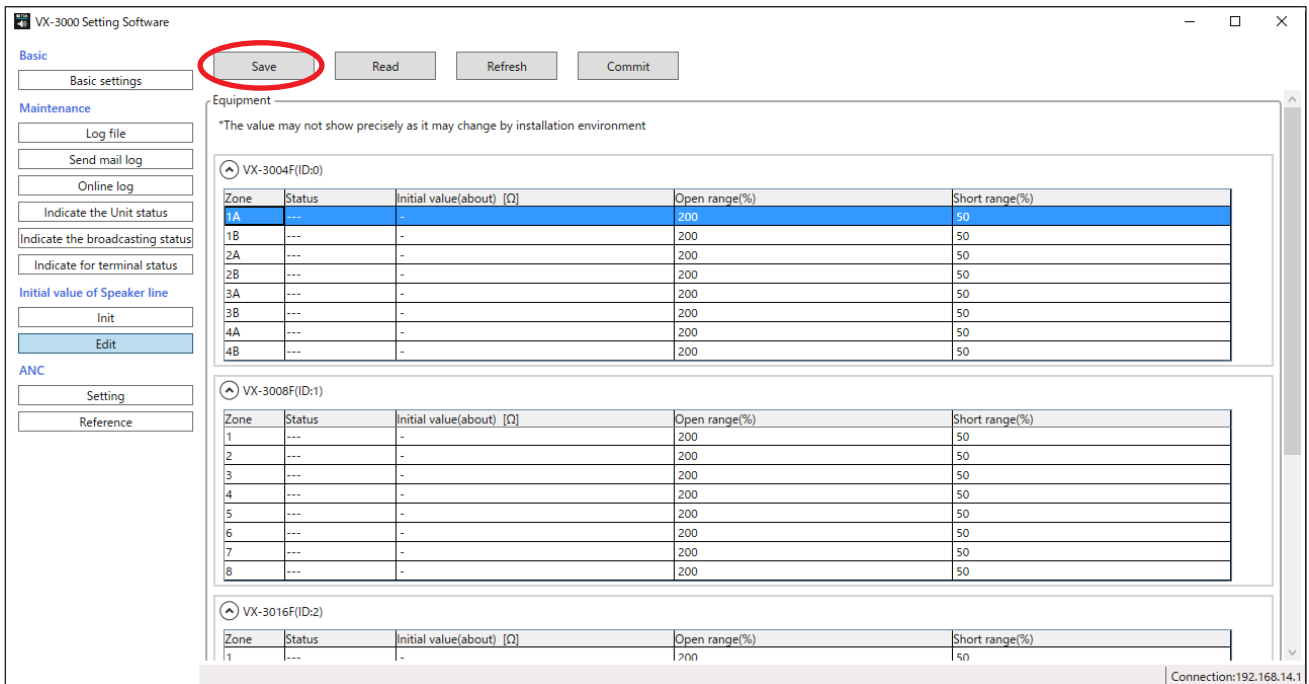

The "Save as" dialog is displayed.

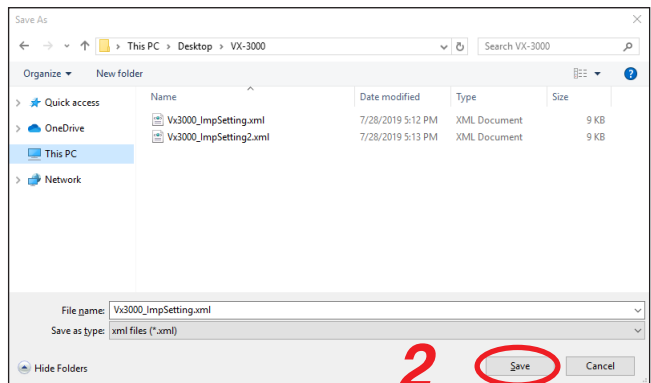

**Step 2.** Select the destination folder, then click the Save button.

### 20.10.6. When uploading the edited impedance setting to the unit

**Step 1.** Click the Commit button.

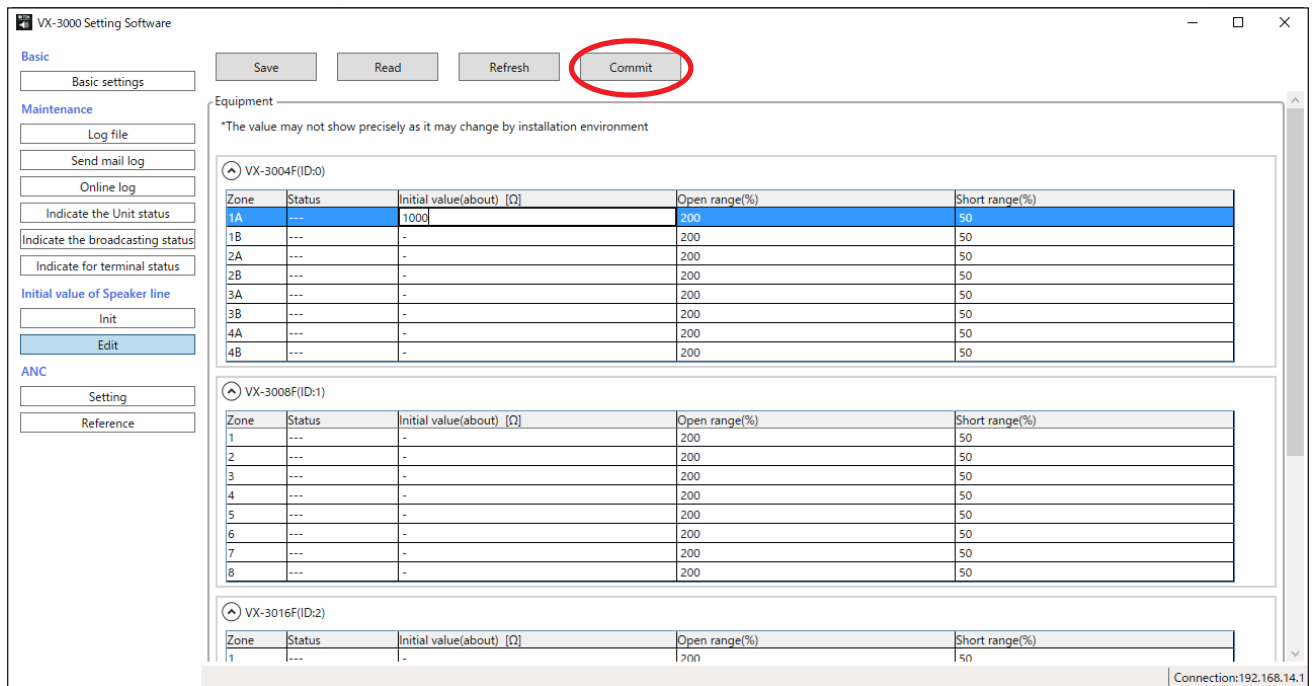

Communication with the unit starts and the edited data will be uploaded to the unit.

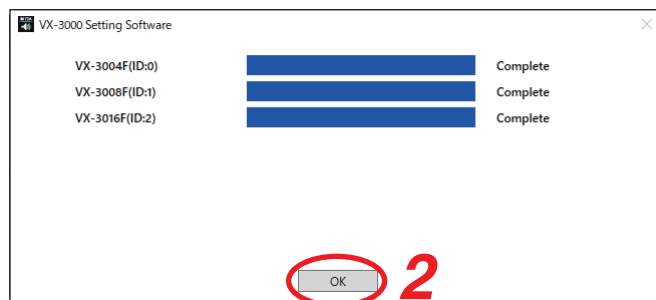

**Step 2.** When the indication "Complete" is displayed, click the OK button.

## 20.11. Measuring the Reference Value of the ANC Sensor Level

Measure the reference value of the ANC sensor level.

### Notes

- Measuring cannot be made during power failure or when in emergency mode.
- Clicking the "Apply settings (PC->VX)" button on the ANC tab in the Sound setting screen during measurement will stop measurement. (See p. 3-156.)

**Step 1.** Establish communications between the VX-3000F and the PC installed with the VX-3000 Setting software.

For the procedure for establishing communications, see p. 3-172.

The "Connection" indication is displayed in the lower right corner of the screen after the connection is completed.

**Step 2.** Click the Setting button of the ANC.

The Setting screen is displayed.

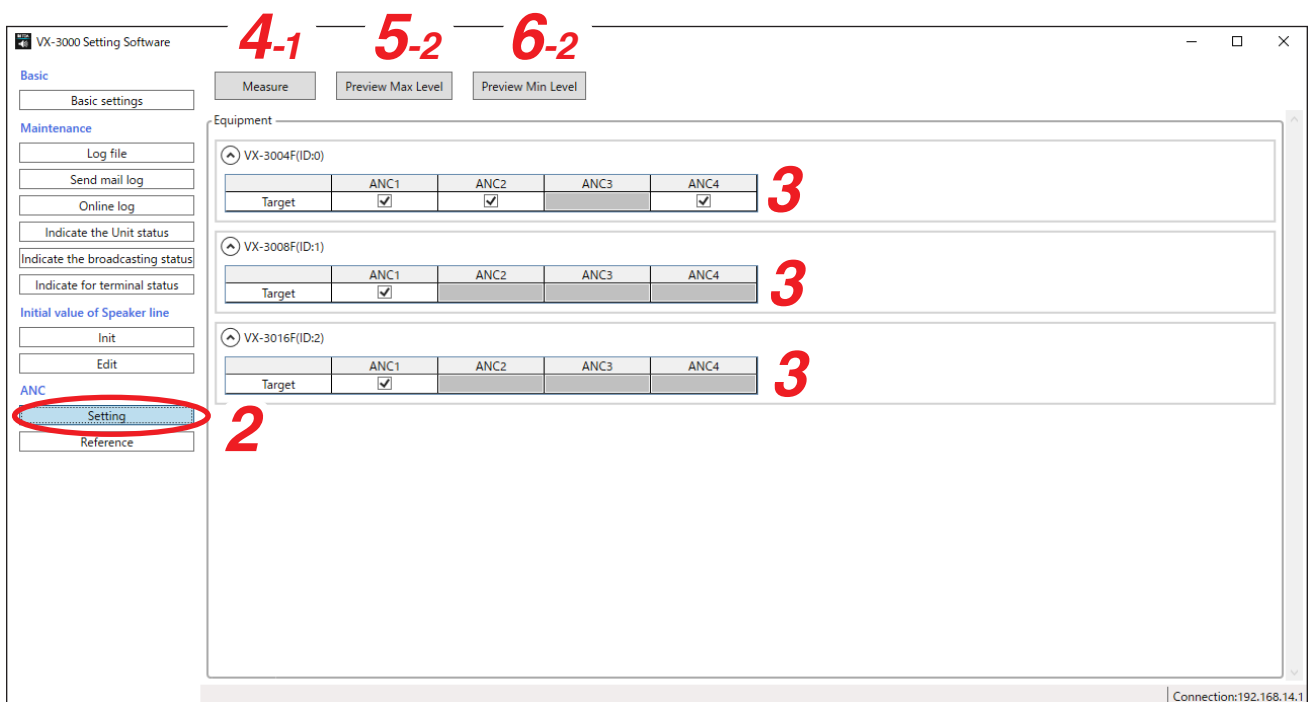

**Step 3.** Place a check mark to the measuring target for the reference value of the sensor level.

### Tips

- All the channels of which Purposes have been set to ANC are set to ON by default.
- Clicking the "Target" cell allows all channels set to ANC of the target device to be turned ON or OFF simultaneously.

**Step 4.** Measure the reference value of the sensor level.

4-1. Click the Measure button.

A confirmation dialog appears.

### Notes

- Perform this operation in the quietest circumstance.
- Do not input the sound source in this procedure.

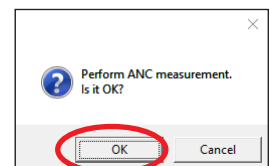

**4-2.** Click the OK button.

Each VX-3000F automatically measures the ambient noise level for the setting target channel for 15 seconds.

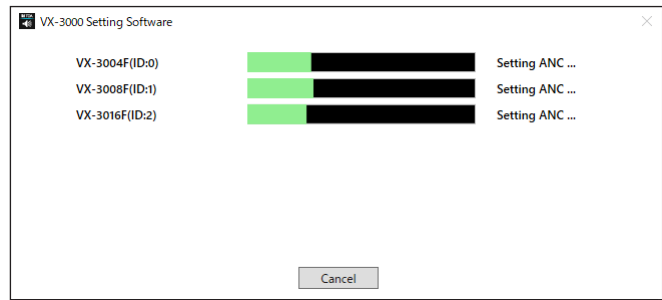

The Complete screen appears when the measurement is successfully completed.

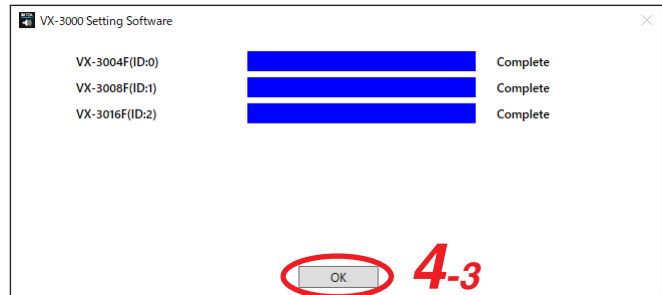
**Tip**

To cancel measurement, click the Cancel button.

Note that you can cancel measurement operation only for the VX-3000F not completing the measurement.

As each VX-3000F's status appears in a dialog, confirm it, then click the OK button.

You cannot restore the VX-3000F of which measurement has been completed to the original state. If necessary, perform measurement again.

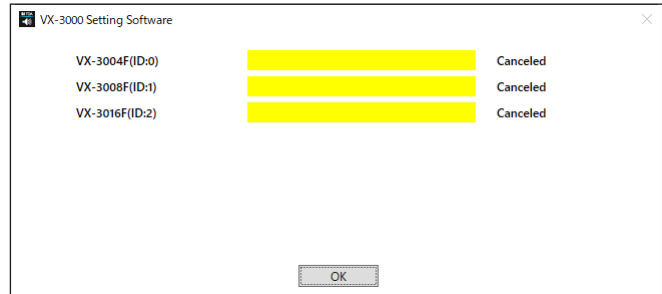
**4-3.** Click the OK button.**Step 5.** Confirm the maximum output level.

**5-1.** Input the sound source to the channel of the setting target.

**5-2.** Click the "Preview Max Level" button.

A confirmation dialog appears.

**5-3.** Click the OK button.

Maximum level applies to the channel of the setting target for 30 seconds. Confirm the output sound volume.

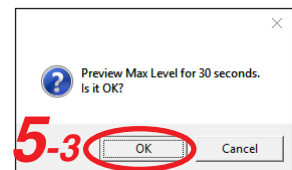
**Step 6.** Confirm the minimum output level.

**6-1.** Input the sound source to the channel of the setting target.

**6-2.** Click the "Preview Min Level" button.

A confirmation dialog appears.

**6-3.** Click the OK button.

Minimum level applies to the channel of the setting target for 30 seconds. Confirm the output sound volume.

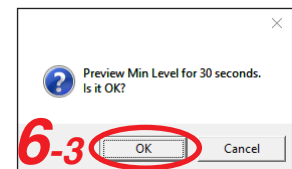

**Step 7.** Reset the maximum and minimum levels of the ANC on the Sound settings (ANC) screen. (See p. 3-156.)

### 20.11.1. Fine-Adjusting the Reference Value of the ANC Sensor Level

If the reference value (value measured on the "Init" screen) of the ANC sensor level differs from the actual ambient noise, fine-adjust the reference value of the sensor level following the procedures below.

#### Note

Measuring cannot be made during power failure or when in emergency mode.

**Step 1.** Establish communications between the VX-3000F and the PC installed with the VX-3000 Setting software.

For the procedure for establishing communications, see [p. 3-172](#).

The "Connection" indication is displayed in the lower right corner of the screen after the connection is completed.

**Step 2.** Click the Reference button of the ANC.

The ANC Reference screen is displayed.

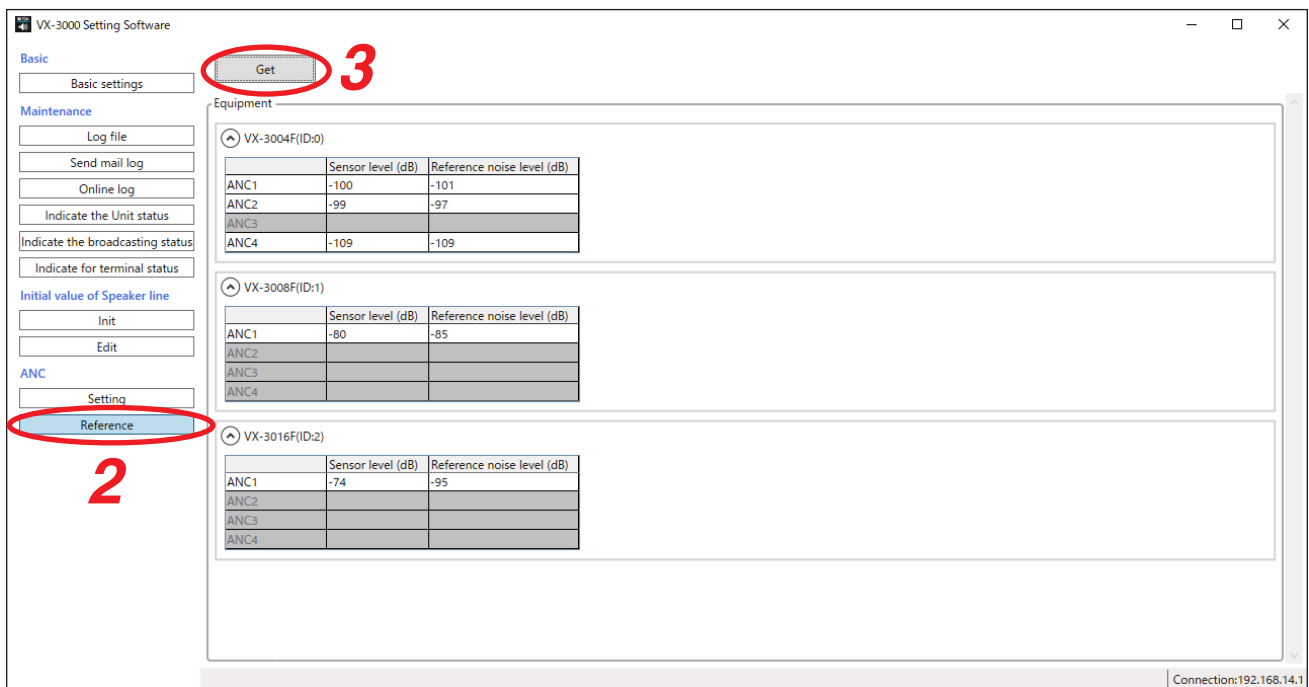

**Step 3.** Click the Get button.

The sensor level and the reference noise level are acquired from the VX-3000F and displayed on the screen.

**Step 4.** Based on the sensor level and reference noise level acquired from the VX-3000F, set the Adjust Zero of the ANC on the Sound setting (ANC) screen. (See [p. 3-156](#).)

## 21. UNIT DETECTION AND NETWORK SETTINGS

Detect the devices connected to the local network and perform the network settings for them.

### Notes

- The VX-3000 Setting software cannot be used to write settings information to units if their IP addresses are not correctly set using the TOA Finder.
- It is not possible to detect the device beyond the router.  
When using the network area division function, detect the devices within each network area and perform the network setting.

### 21.1. Activating the TOA Finder

Select [Maintenance] → [Unit detection & network settings] from the menu bar to activate the TOA Finder.

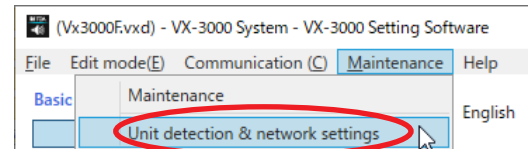

### Note

When multiple IP addresses are set in a PC, the source IP address selection screen is displayed before the unit detection is executed, then select the desired IP address.

[TOA Finder]

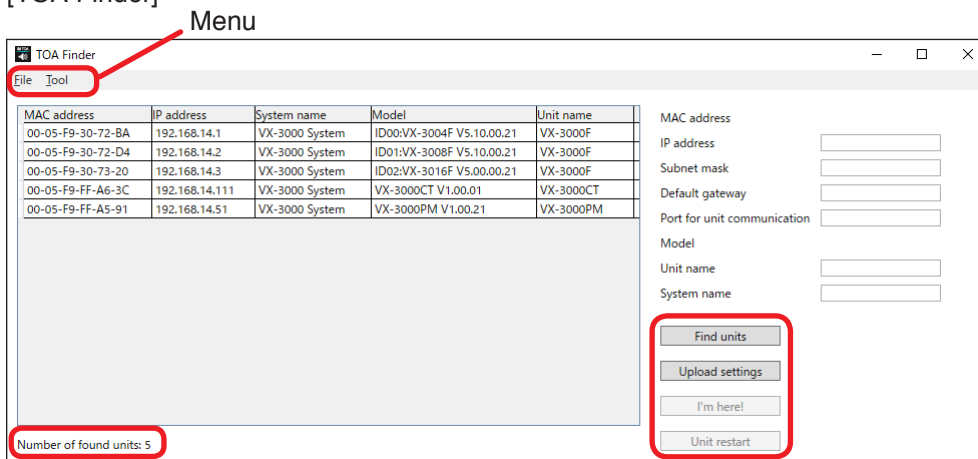

The number of the detected units

Buttons

#### 21.11.1. TOA Finder's menu

File	Exit	Exits the program.
Tool	Select source IP address	Selects the IP address of the PC to be used for unit detection. Only units connected to the local network having the selected IP address can be detected.
	Find units	Detects and displays all units connected to the local network.
	Upload settings	Uploads the settings contents changed on the software screen to the unit.

#### 21.11.2. TOA Finder's button

Find units button	Detects and displays all units connected to the local network.
Upload settings button	Uploads the settings contents changed on the software screen to the unit.
"I'm here!" button	Use this button when confirming which VX-3000 unit is the one selected in the Detected unit list. All indicators of the corresponding VX-3000 units light, and the buzzer sounds as well in the case of the VX-3000F. (See p. 3-208.)
Unit restart button	Restarts the VX-3000 unit selected in the Detected unit list. (See p. 3-208.)

## 21.2. Detecting Units

### Notes

- Units may not be detected if the firewall function of the PC on which the TOA Finder is installed is enabled. In such cases, change the firewall settings and remove the block to the TOA Finder.
- The range that can be detected is only the range that is valid for broadcast communication from the source IP address. For the units that cannot be scanned, manually add only the units connected to the LAN with the VX-3000 Setting software.

**Step 1.** Connect the VX-3000F, VX-3000PM, and VX-3000CT to the network and connect the power supply to each unit.

The power indicator and the run indicator light.

**Step 2.** Click the Find units button on the TOA Finder's initial screen or select [Tool] → [Find units] from the menu.

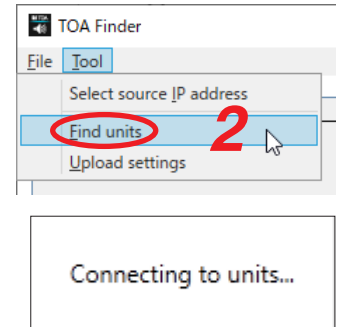

The dialog shown at right is displayed.

The list of all network information on the VX-3000F units connected to the local network is displayed.

The following values are set by default:

IP address: 192.168.14.1

Subnet mask: 255.255.255.0

Default gateway: 0.0.0.0

Unit name: "VX-3000F," "VX-3000PM," or "VX-3000CT" depending on the unit type

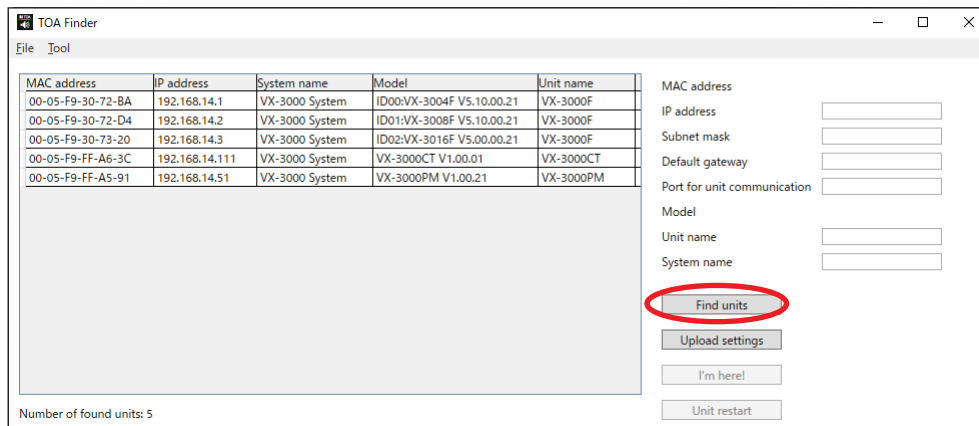

### 21.3. Detect Unit Screen Description

Shown below is an example of the screen displayed after the units have been scanned. When selecting the unit, click the relevant unit in the detected unit list.

#### Unit Information list

Displays information on the unit selected in the detected unit list.

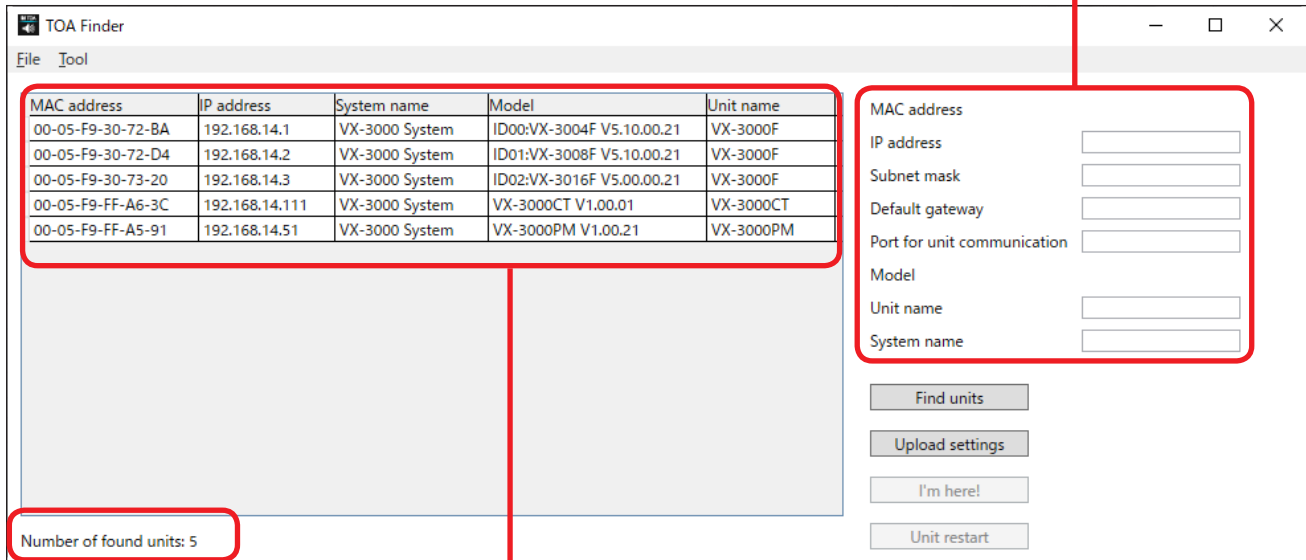

The number of the detected units

#### Detected unit list

Displays all units detected with the TOA Finder.

#### • Settings items for the unit information list

MAC address	Displays the detected unit's MAC address. Cannot be changed.
IP address	Sets the detected unit's IP address.
Subnet mask	Sets the detected unit's subnet mask.
Default gateway	Sets the detected unit's default gateway.
Port for unit communication (VX-3000PM or VX-3000CT only)	Sets the port number of the VX-3000PM and the VX-3000CT to make inter-device control. <b>Note</b> Be sure to assign the same value to the unit communication port of the VX-3000F unit, and that of the VX-3000PM or VX-3000CT unit ( <a href="#">p. 3-72</a> ).
Web port	Sets the web server's port number.
Model	Displays the unit's model name. Cannot be changed.
Unit name	Sets the name of the unit registered in the system. Up to 32 alphanumeric characters can be set.
System name	Displays the system name set in the system. Up to 32 alphanumeric characters can be set.

## 21.4. Finding VX-3000 Unit

Follow the procedures below to confirm which VX-3000 unit is the detected one.

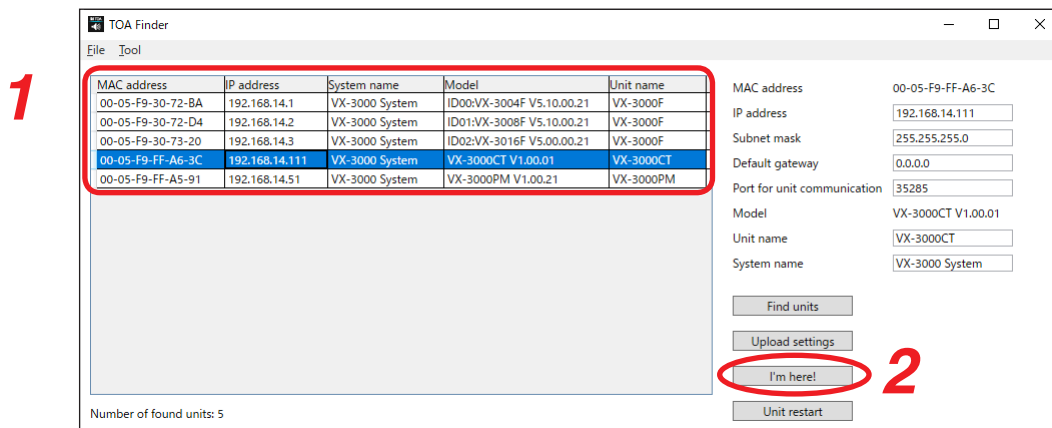

**Step 1.** Click the cell of the VX-3000 unit to search on the detected unit.

**Step 2.** Click the "I'm here!" button on the TOA Finder's screen.

All indicators on the selected VX-3000 unit's front panel light, and the buzzer sounds for 3 seconds as well in the case of the VX-3000F.

### Tip

This operation stops when the "I'm here!" button is clicked again while all indicators are lighting and the buzzer is sounding.

## 21.5. Restarting VX-3000 Unit

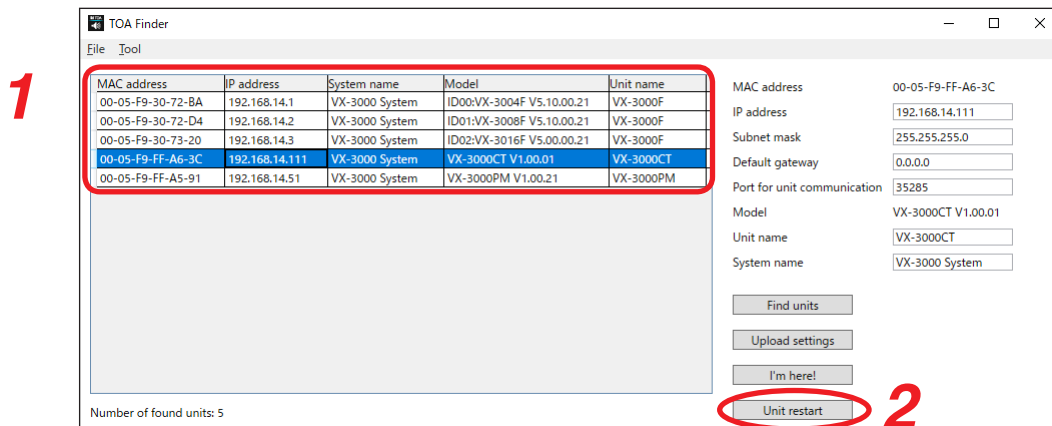

**Step 1.** Click the cell of the VX-3000 unit to restart the unit.

**Step 2.** Click the Unit restart button on the TOA Finder's screen.

The selected VX-3000 unit restarts.

## 21.6. Changing the Unit Setting Values Related to the Network

Unit setting values can be changed individually.

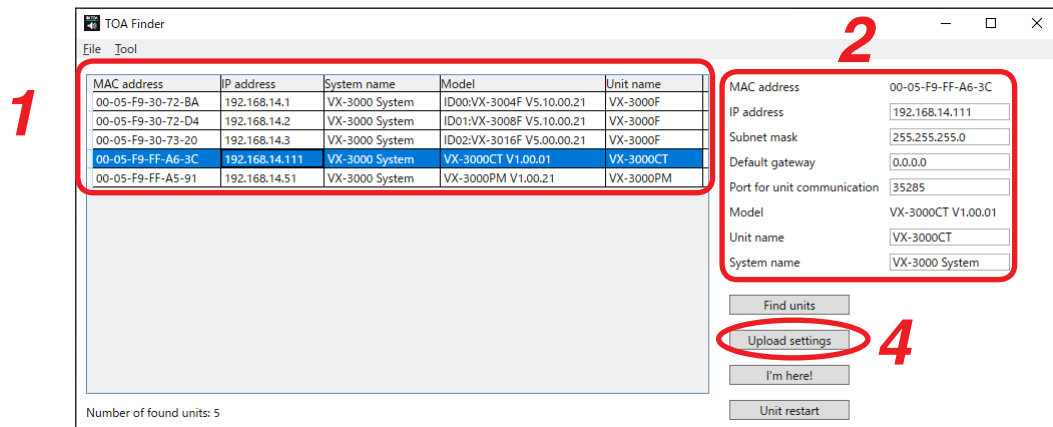

**Step 1.** Click the cell on the detected unit list to be changed.

The unit information list is placed in a mode that allows the unit information list to be input.

### Note

If the warning dialog appears, change the VX-3000F's device settings as shown below.

In the case of the VX-3000F, set switch 8 of the IP address setting switch to OFF.

In the case of the VX-3000PM, set switch 1 of the IP address setting switch to OFF.

In the case of the VX-3000CT, set switch 1 of the IP address setting switch to OFF.

For details, see the separate installation manual, "Setting the IP Address."

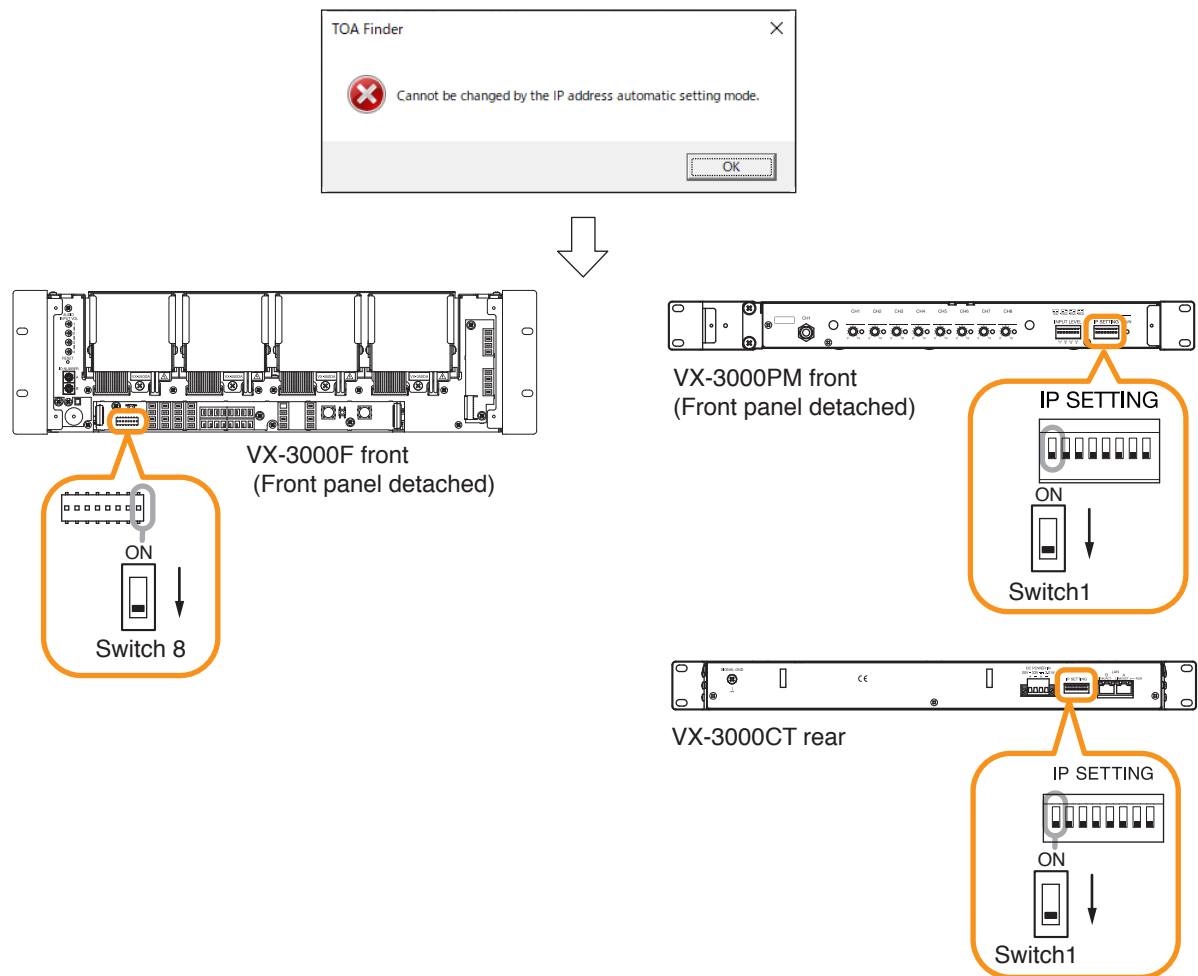

**Step 2.** Input a new setting value into the unit information list.

Items that can be set are as follows:

- IP address
- Subnet mask
- Default gateway
- Port for unit communication (the VX-3000PM and VX-3000CT only)
- Unit name
- System name

**Step 3.** Follow **Steps 1** and **2** for all units to be changed.

**Step 4.** After editing all changes, click the Upload settings button.  
The new setting values are uploaded to the unit.

**Note**

Since the unit is automatically reset after uploading, the broadcast stops and may be terminated.

## 22. PRINTING LABELS FOR REMOTE MICROPHONES

To print a label for a remote microphone, use the Setting software to output the microphone's function key assignments to an Excel file (book).

### Note

Printing this label will require that Excel has been installed and configured correctly on the PC.

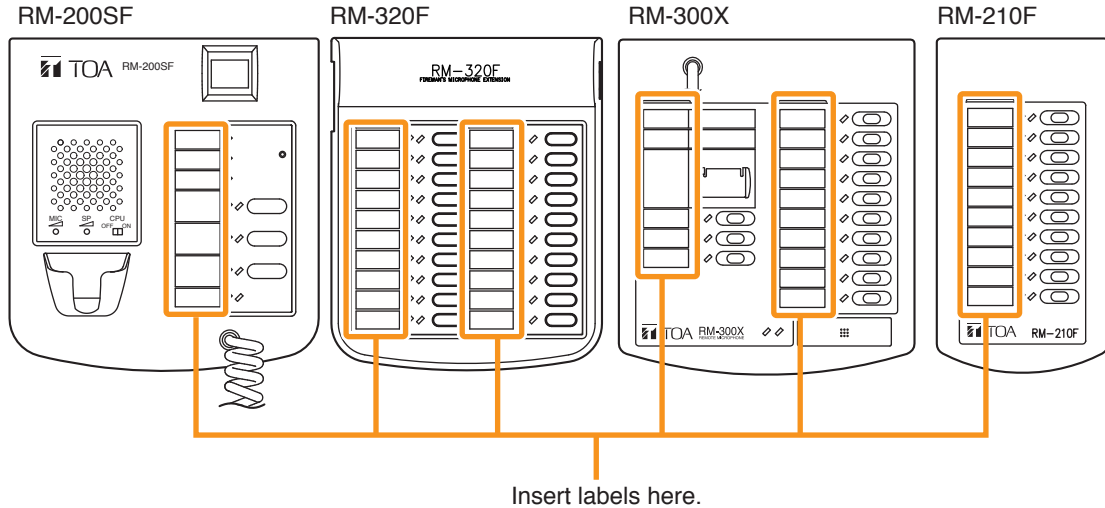

**Step 1.** Select [File] → [Data output] → [RM label] from the menu bar on the Setting software.

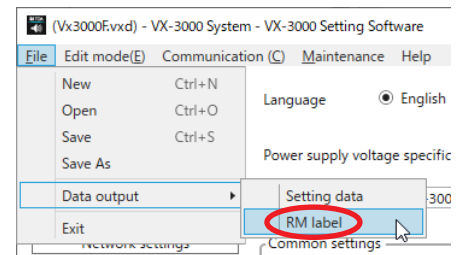

A "Save As" dialog is displayed.

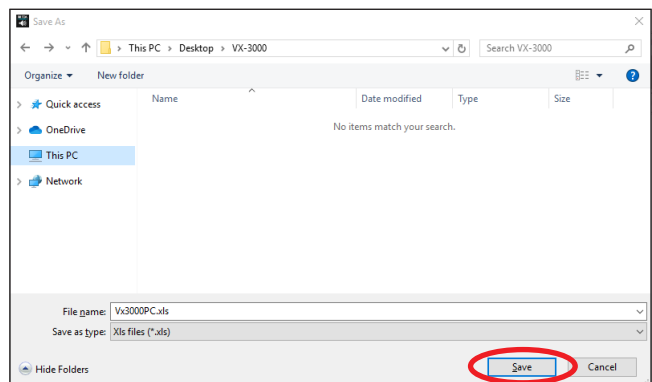

**Step 2.** Select the folder where the data for label print is to be saved.

**Step 3.** Set a "File name."

**Notes**

- The filename "Vx3000PC.xls" is assigned by default.
- When changing the filename, be sure to add a filename extension (xls).  
Example: 0605rm\_label.xls

**Step 4.** Click the Save button.

Read of the data for printing labels starts.

The screen below is displayed during data read.

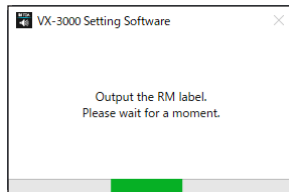

The screen below is displayed after the data read has been completed.

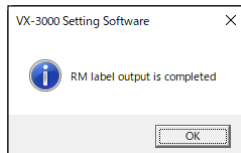

Based on their ID numbers, separate worksheets are produced in the resulting Excel file (book) for each RM-200SF or RM-300X unit connected to the VX-3000F.

The initial printing range for each ID number is 1 page for the RM-200SF or RM-300X. It is also 1 page for the RM-320F or RM-210F when an RM-320F or RM-210F is connected to the RM-200SF or RM-300X, and this applies even if multiple RM-320F or RM-210F units are connected.

**Step 5.** Open the saved .xls (Excel) file and print.

**Notes**

- The actual print area and the width of the printed label may vary slightly depending on the type of printer used.
- If the labels cannot be printed out correctly, see the separate Installation Manual, "Creating remote microphone name labels."
- The paper used for the name label must be under 0.2 mm in thickness.



## 23. USER AUTHENTICATION SETTING (allowed only by Administrator authority)

### 23.1. Types of Access Level

Four types of access level described below are available for the VX-3000 Setting software to limit the usable range depending on the user level.

- End User: Only the references of device conditions and history data are allowed.
- Advanced End User: Only updating the built-in sound source data, the timer setting, and the maintenance function are allowed to perform.
- Installer: All functions except changing the password for user authentication are allowed to use.
- Administrator: All functions are allowed to use.

### 23.2. Changing the Password for Each Access Level

To use the VX-3000 Setting software with the access level other than End User, password entry is required. The passwords shown below are set by default. Only when the software is activated with the Administrator authorization, the password can be changed.

- Advanced End User: advancedenduser  
 Installer: installer  
 Administrator: administrator

**Step 1.** Activate the VX-3000 Setting software with the Administrator authority.

**Step 2.** Select [Help] → [User authentication setting] from the menu bar.

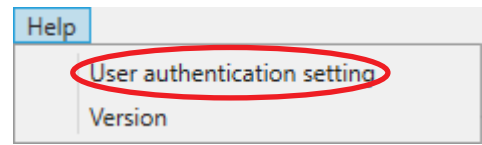

A user authentication setting screen is displayed.

**Step 3.** Enter the password of the access level to change, then click the Update button.  
 Enter the password with up to 32 alphanumeric characters.

**Tip**

If you do not enter any character, password is set to "No password required."

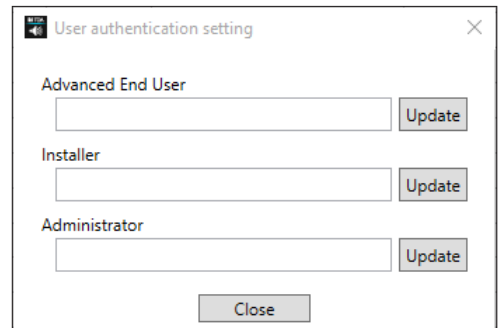

A password reentry dialog is displayed.

**Step 4.** Enter the password again, then click the OK button.

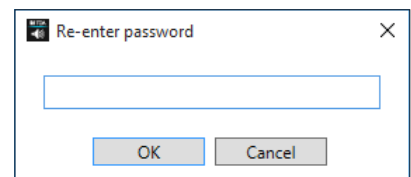

An update complete dialog is displayed.

**Step 5.** Click the OK button.

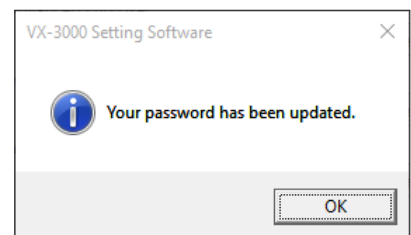

**Step 6.** To change the password for another access level, repeat **Steps 3 to 5.**

**Step 5.** Click the Close button.

